

# Onka®

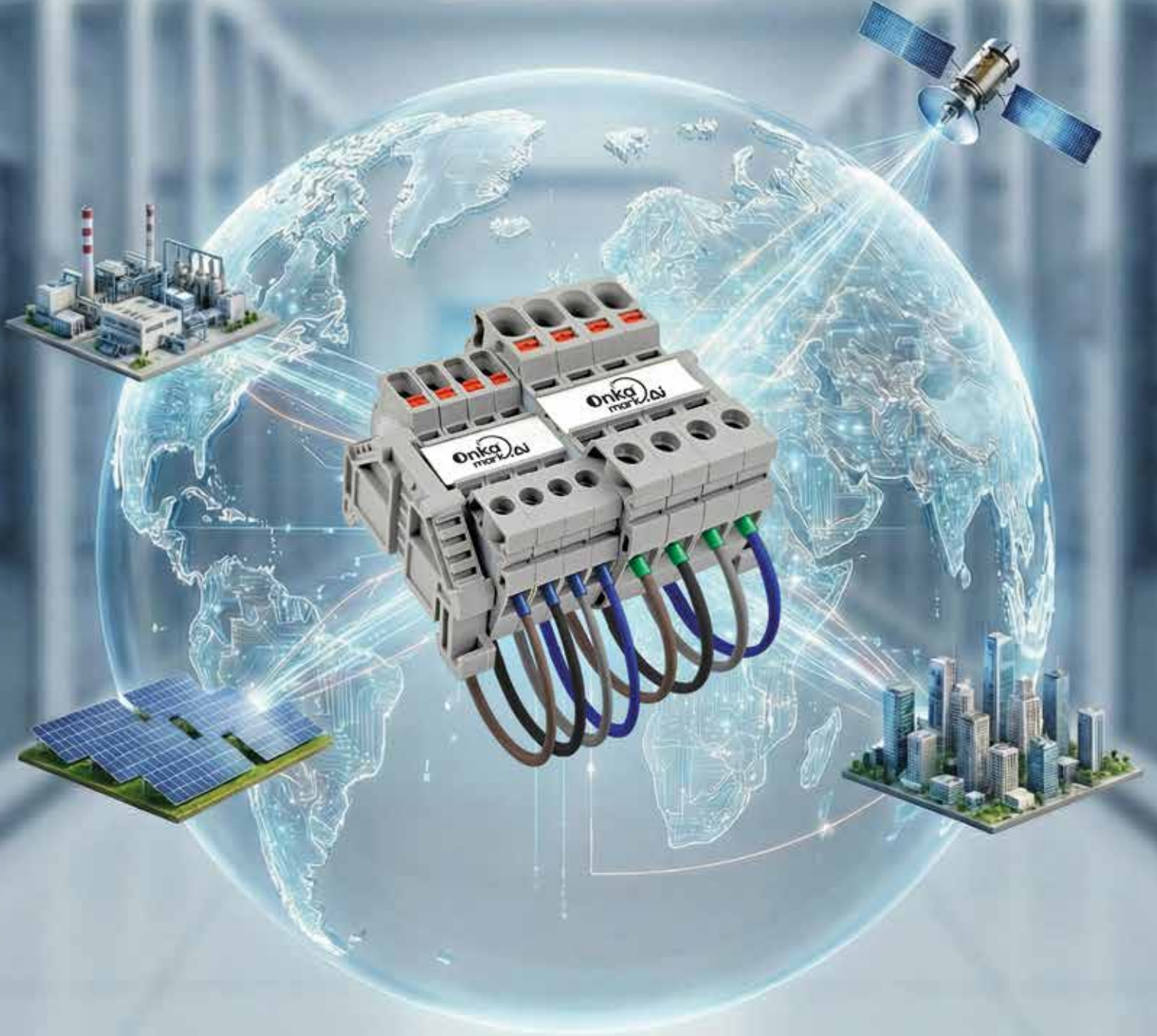

TEDARİKÇİNİN EL KİTABI  
2026

[www.Onka.com.tr](http://www.Onka.com.tr)

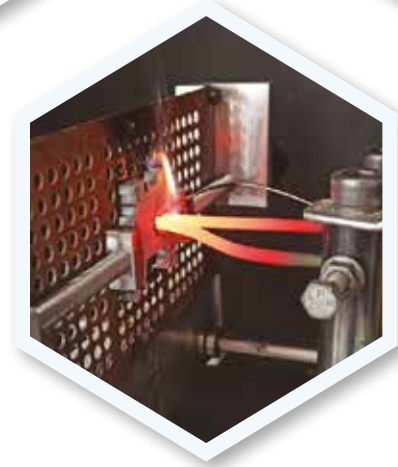

# Onka®

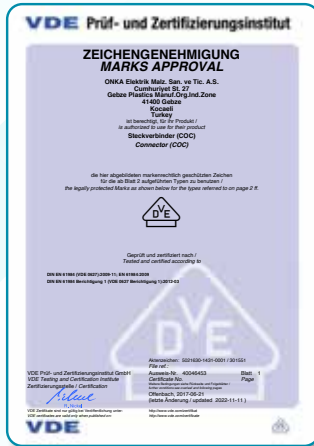
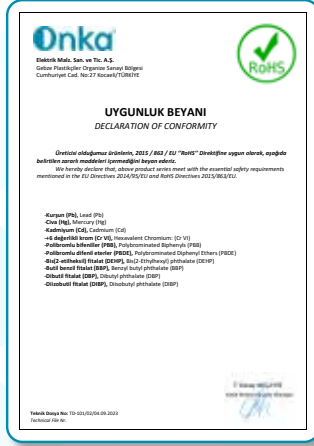

CEZAYİR  
ÇEK CUMHURİYETİ  
ÇEKYA  
DUBAİ  
EKVATOR  
ENDONEZYA  
ERMENİSTAN  
ESTONYA  
ETİYOPYA  
FAS  
FİLDİŞİ SAHİLİ  
FİLİSTİN  
FİNLANDIYA  
FRANSA

AFGANİSTAN  
ALMANYA  
AMERİKA  
ARNAVUTLUK  
AZERBAYCAN  
AVUSTRALYA  
BAHREYN  
BANGLADEŞ  
BELÇİKA  
BEYAZ RUSYA  
BOSNA HERSEK  
BULGARİSTAN  
BURKİNA FASO

GHANA  
GUATAMELA  
GÜNEY AFRİKA  
GÜRCİSTAN  
HİNDİSTAN  
HOLLANDA  
HONG KONG  
HONDURAS

ŞİLİ  
TAYLAND  
TUNUS  
TÜRKİYE  
TÜRKMENİSTAN  
UGANDA  
UKRAYNA  
UMMAN  
URUGUAY  
ÜRDÜN  
VIETNAM  
YEMEN  
YUNANİSTAN

IRAK  
İNGİLTERE  
İRLANDA  
İSPANYA  
İSRİL  
İSVEÇ  
İTALYA

ÖZBEKİSTAN  
PAKİSTAN  
PANAMA  
PERU  
POLONYA  
PORTEKİZ  
ROMANYA  
SUUDI ARABİSTAN  
SENEGAL  
SİRBİSTAN  
SİNGAPUR  
SLOVENYA  
SRİ LANKA  
SUDAN  
SURIYE

MACARİSTAN  
MAKEDONYA  
MALDİVLER  
MALEZYA  
MALİ  
MALTA  
MAURITIUS  
MEKSİKA  
MISIR  
MOLDOVA  
NİJERYA

KAMERUN  
KATAR  
KAZAKİSTAN  
KENYA  
KIBRIS  
KOLOMBİYA  
KOSOVA  
KOSTARIKA  
KUVEYT  
LETONYA  
LİBYA  
LİTVANYA  
LÜBNAN

## Vida Bağlantılı Ray Klemensler **6**

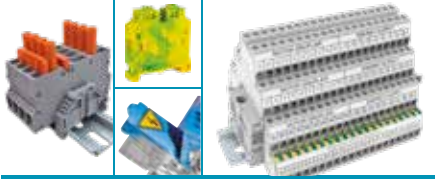

## Montaj Rayları **87**



## Kablo Kanalları **130**

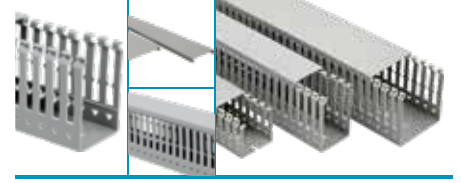

## Yay Bağlantılı Ray Klemensler **32**

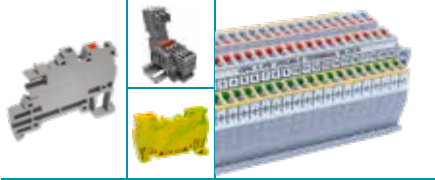

## Sıkmalı Kablo Pabuçları **92**



## Kablo Uçları **132**



## Mini Yay Bağlantılı Ray Klemensler **55**

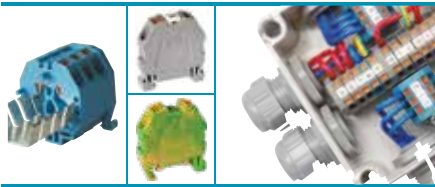

## Sıra Klemensler **106**



## Kablo Bağları ve Aksesuarları **143**

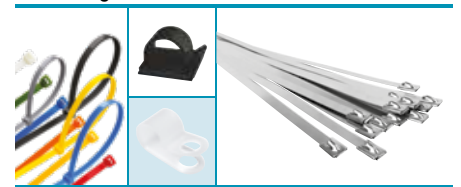

## Markalama Sistemleri **63**



## Kablo ve Pano Aksesuarları **117**

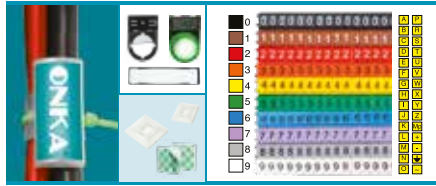

## Bimetal Klemensler (Al-Cu) **154**



## Dağıtıcı Üniteler **74**



## Poliamid Kablo Rakorlar **123**



## İzolatörler **163**



## W Otomat Baraları **81**

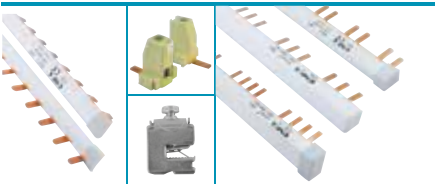

## Ray Tipi Prizler **129**



## Makaronlar **202**



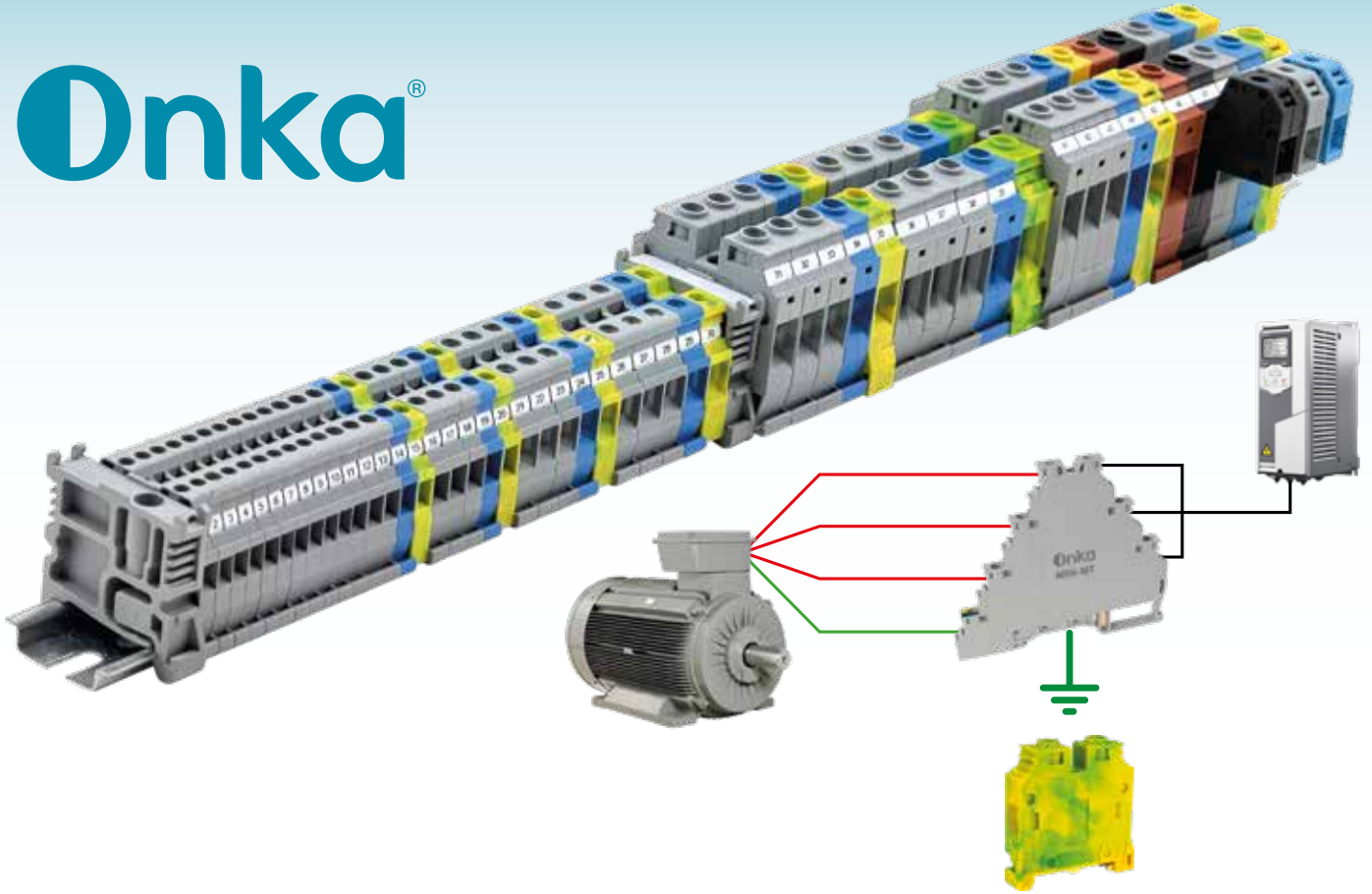

## MRK SERİSİ

## Vida Bağlantılı Ray Klemensler

- Nihayet plakası gerektirmez. (Her iki tarafı kapalı)
- Daha iyi bir izolasyon ve maliyet avantajı sağlar.
- 0,25 mm<sup>2</sup> den 240 mm<sup>2</sup> kablo kesitine kadar montaj imkanı sağlar.
- Renk Kodlama / Dekafix / Şerit Etiketleme olanaklarıyla evrensel markalama avantajları
- Çift yönlü köprüleme imkanı.
- 1,5 mm<sup>2</sup> den 10 mm<sup>2</sup> ye kadar izoleli tarak köprü kullanılabilir.
- Vida sistemi 1,5 mm<sup>2</sup> den 35 mm<sup>2</sup> ye kadar düz başlı, 50 mm<sup>2</sup> ve sonraki kesitlerde alyan başlıdır.
- Ergonomik ve kompakt tasarımlara imkan sağlayarak montaj alanını minimize eder.
- MRK Serisi 1.5-2.5-4-6-10-16-25-35-50-70-95-120 mm<sup>2</sup> kesitlerde üretilmektedir.
- Klemens içerisindeki bakır bara ve kovan iç çeperinde yapılan setler, montajı tamamlanan iletken üzerinde maksimum güvenli bağlantı sağlar.
- MRK 16, 25 ve 35'in köprüleme sistemi vidalı üst köprüdür.

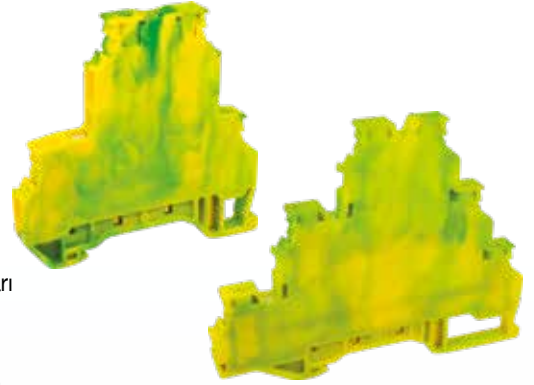

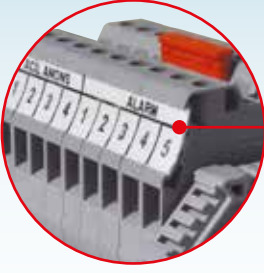

MRK Serisinde 1.5 mm<sup>2</sup> den 35 mm<sup>2</sup> kesite kadar şerit etiketleme sistemi uygulanabilir.

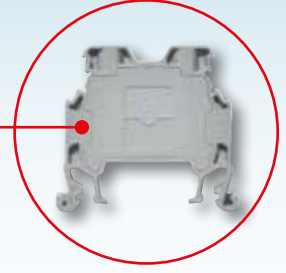

Ana gövde tek parça ve nihayet plakası içine gömülü olarak üretilmiştir.



MRK Serisinde 1.5 mm<sup>2</sup> den 10 mm<sup>2</sup> ye kadar geçmeli üst köprü sistemi kullanılır.

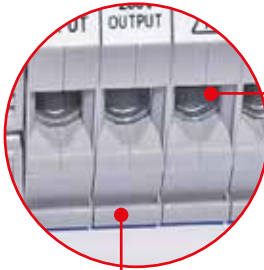

MRK 6-10-16 ve 35'in kovan sisteminin alt kısmındaki U formu sayesinde kovanın kabloya daha fazla teması sağlanır.

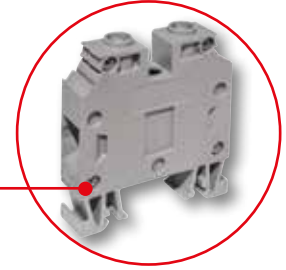

MRK 16 ve 35'te klemensin gövdesi ve kapağı birbirine 4 adet çelik vida ile sabitlenmiştir.



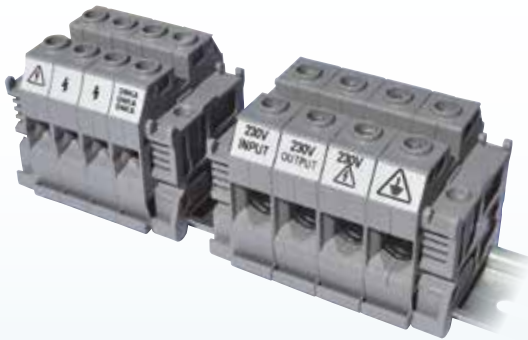



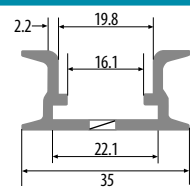
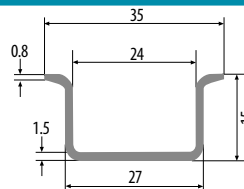
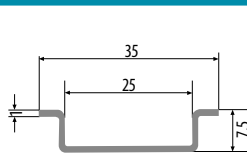





































MRK 16 ve 35'in raya montaj ayaklarının gövde genişliğinde olması sayesinde ray üzerinde daha geniş ve rijit kavrama, güvenli ve sağlam montaj imkanı.



## MONTAJ RAYI ÇEŞİTLERİ







































## MRK SERİSİ VİDA BAĞLANTILI RAY KLEMENSLER (HER İKİ TARAFI KAPALI SİSTEM)

CİNSİ	GERİLİM / AKIM (V/A)	KUTU ADEDİ	RENK	ÜRÜN KODU	ESKİ KOD	ADET (₺)	ÜRÜN KODU (V0)	ESKİ KOD (V0)	ADET (V0) (₺)
MRK 1,5 mm <sup>2</sup>	750 V / 17,5 A	100		1010001	ONKA-1001	34,00			35,60
				1010002	ONKA-1002		1010151	ONKA-0752	
				1010003	ONKA-1003				
				1010004	ONKA-1004				
				1010005	ONKA-1005				
				1010006	ONKA-1006				
				1010007	ONKA-1007				
				1010008	ONKA-1008				
				1010009	ONKA-1009		1010152	ONKA-0759	
			MRK 2,5 mm <sup>2</sup>	750 V / 24 A	100			1010011	
	1010012	ONKA-1012				1010153	ONKA-0762		
	1010013	ONKA-1013				1010154	ONKA-0763		
	1010014	ONKA-1014				1010155	ONKA-0764		
	1010015	ONKA-1015				1010156	ONKA-0765		
	1010016	ONKA-1016				1010157	ONKA-0766		
	1010017	ONKA-1017				1010158	ONKA-0767		
	1010018	ONKA-1018				1010159	ONKA-0768		
	1010019	ONKA-1019				1010160	ONKA-0769		
MRK 4 mm <sup>2</sup>	750 V / 32 A	100					1010021	ONKA-1021	37,80
				1010022	ONKA-1022	1010162	ONKA-0772		
				1010023	ONKA-1023	1010163	ONKA-0773		
				1010024	ONKA-1024	1010164	ONKA-0774		
				1010025	ONKA-1025	1010165	ONKA-0775		
				1010026	ONKA-1026	1010166	ONKA-0776		
				1010027	ONKA-1027	1010167	ONKA-0777		
				1010028	ONKA-1028				
				1010029	ONKA-1029				
			MRK 6 mm <sup>2</sup>	750 V / 41 A	100		1010031	ONKA-1031	
	1010032	ONKA-1032				1010168	ONKA-0782		
	1010033	ONKA-1033				1010169	ONKA-0783		
	1010034	ONKA-1034				1010170	ONKA-0784		
	1010035	ONKA-1035				1010171	ONKA-0785		
	1010036	ONKA-1036				1010172	ONKA-0786		
	1010037	ONKA-1037				1010173	ONKA-0787		
	1010038	ONKA-1038							
	1010039	ONKA-1039							
MRK 10 mm <sup>2</sup>	750 V / 57 A	100					1010041	ONKA-1041	83,75
				1010042	ONKA-1042	1010174	ONKA-0792		
				1010043	ONKA-1043	1010175	ONKA-0793		
				1010044	ONKA-1044	1010176	ONKA-0794		
				1010045	ONKA-1045	1010177	ONKA-0795		
				1010046	ONKA-1046	1010178	ONKA-0796		
				1010047	ONKA-1047	1010179	ONKA-0797		
				1010048	ONKA-1048				
				1010049	ONKA-1049				



## MRK SERİSİ VİDA BAĞLANTILI RAY KLEMENSLER (HER İKİ TARFI KAPALI SİSTEM)

CİNSİ	GERİLİM / AKIM (V/A)	KUTU ADEDİ	RENK	ÜRÜN KODU	ESKİ KOD	ADET (t)	ÜRÜN KODU (V0)	ESKİ KOD (V0)	ADET (V0) (t)
MRK 16 mm <sup>2</sup>	750 V / 76 A	50		1010650		122,60	1010659		129,00
				1010651			1010660		
				1010652			1010661		
				1010653			1010662		
				1010654			1010663		
				1010655			1010664		
				1010656			1010665		
				1010657			1010666		
				1010658			1010667		
			MRK 16 mm <sup>2</sup>	750 V / 76 A	50			1010051	
	1010052	ONKA-1132				1010209	ONKA-0882		
	1010053	ONKA-1133				1010539	ONKA-0883		
	1010054	ONKA-1134				1010540	ONKA-0884		
	1010055	ONKA-1135				1010537	ONKA-0885		
	1010056	ONKA-1136				1010538	ONKA-0886		
	1010057	ONKA-1137				1010570	ONKA-0887		
	1010058	ONKA-1138							
	1010059	ONKA-1139							
MRK 25 mm <sup>2</sup>	750 V / 101 A	50					1010061	ONKA-0301	154,30
				1010062	ONKA-0302	1010180	ONKA-0802		
				1010063	ONKA-0303	1010181			
				1010064	ONKA-0304	1010182			
				1010065	ONKA-0305	1010183			
				1010066	ONKA-0306	1010184			
				1010067	ONKA-0307	1010185			
				1010068	ONKA-0308				
				1010069	ONKA-0309				
			MRK 35 mm <sup>2</sup>	750 V / 125 A	30		1010071	ONKA-1141	
	1010072	ONKA-1142				1010210	ONKA-0892		
	1010073	ONKA-1143							
	1010074	ONKA-1144							
	1010075	ONKA-1145							
	1010076	ONKA-1146							
	1010077	ONKA-1147							
	1010078	ONKA-1148							
	1010079	ONKA-1149							







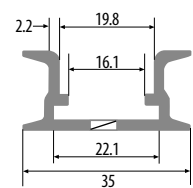
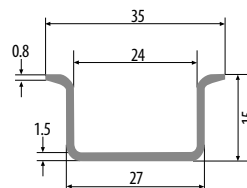
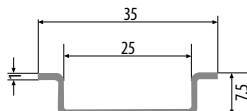











































Yüksek Tip



**YÜKSÜKSÜZ**

### MONTAJ RAYI ÇEŞİTLERİ

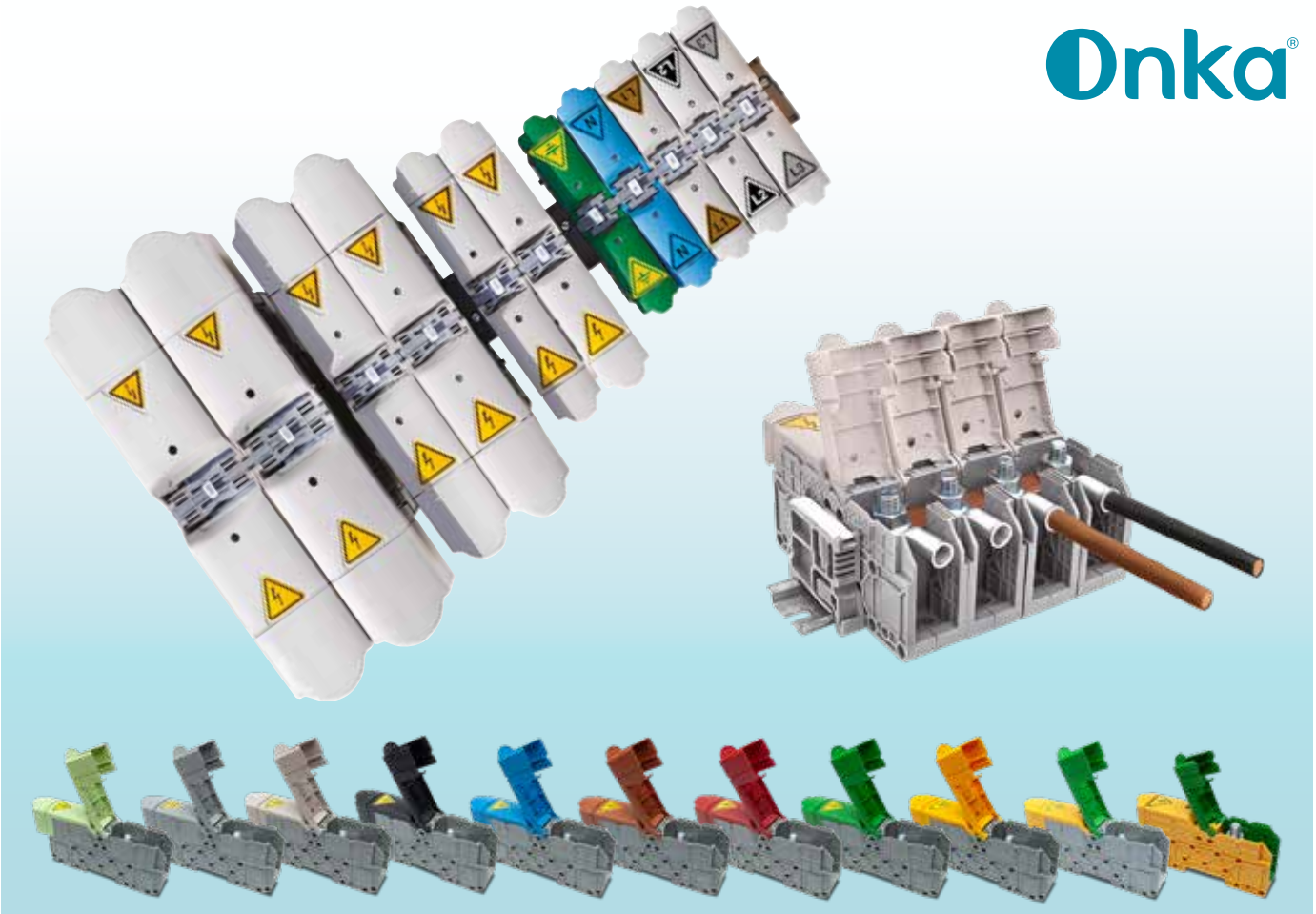

## MRK SERİSİ VİDA BAĞLANTILI RAY KLEMENSLER (HER İKİ TARAFI KAPALI SİSTEM)

CİNSİ	GERİLİM / AKIM (V/A)	KUTU ADEDİ	RENK	ÜRÜN KODU	ESKİ KOD	ADET (t)	ÜRÜN KODU (V0)	ESKİ KOD (V0)	ADET (V0) (t)
MRK 35 mm <sup>2</sup>	750 V / 125 A	30		1010081	ONKA-1061	214,85			224,60
				1010082	ONKA-1062		1010186	ONKA-0812	
				1010083	ONKA-1063		1010187	ONKA-0813	
				1010084	ONKA-1064		1010188	ONKA-0814	
				1010085	ONKA-1065		1010189	ONKA-0815	
				1010086	ONKA-1066		1010190	ONKA-0816	
				1010087	ONKA-1067		1010191	ONKA-0817	
				1010088	ONKA-1068		1010192	ONKA-0818	
				1010089	ONKA-1069		1010193	ONKA-0819	
			Yüksek Tip		30			1010091	
	1010092	ONKA-1072				1010194	ONKA-0822		
	1010093	ONKA-1073				1010195	ONKA-0823		
	1010094	ONKA-1074				1010196	ONKA-0824		
	1010095	ONKA-1075				1010197	ONKA-0825		
	1010096	ONKA-1076				1010198	ONKA-0826		
	1010097	ONKA-1077				1010199	ONKA-0827		
	1010098	ONKA-1078				1010200	ONKA-0828		
	1010099	ONKA-1079				1010201	ONKA-0829		
MRK 50 mm <sup>2</sup>	750 V / 150 A	20					1010101	ONKA-1081	719,10
				1010102	ONKA-1082	1010202	ONKA-0832		
				1010103	ONKA-1083				
				1010104	ONKA-1084				
				1010105	ONKA-1085	1010203	ONKA-0835		
				1010106	ONKA-1086				
				1010107	ONKA-1087				
				1010108	ONKA-1088				
				1010109	ONKA-1089				
			MRK 70 mm <sup>2</sup>	750 V / 192 A	20		1010111	ONKA-1091	
	1010112	ONKA-1092				1010204	ONKA-0842		
	1010113	ONKA-1093							
	1010114	ONKA-1094							
	1010115	ONKA-1095				1010205	ONKA-0845		
	1010116	ONKA-1096							
	1010117	ONKA-1097							
	1010118	ONKA-1098							
	1010119	ONKA-1099							
MRK 95 mm <sup>2</sup>	1000 V / 232 A	10					1010121	ONKA-1101	1.303,40
				1010122	ONKA-1102	1010206	ONKA-0852		
				1010123	ONKA-1103				
				1010124	ONKA-1104				
				1010125	ONKA-1105				
				1010126	ONKA-1106				
				1010127	ONKA-1107				
				1010128	ONKA-1108				
				1010129	ONKA-1109				
			MRK 120 mm <sup>2</sup>	1000 V / 269 A	10		1010121	ONKA-1101	
	1010122	ONKA-1102				1010206	ONKA-0852		
	1010123	ONKA-1103							
	1010124	ONKA-1104							
	1010125	ONKA-1105							
	1010126	ONKA-1106							
	1010127	ONKA-1107							
	1010128	ONKA-1108							
	1010129	ONKA-1109							
MRK 120 mm <sup>2</sup>	1000 V / 269 A	10					1010121	ONKA-1101	1.303,40
				1010122	ONKA-1102	1010206	ONKA-0852		
				1010123	ONKA-1103				
				1010124	ONKA-1104				
				1010125	ONKA-1105				
				1010126	ONKA-1106				
				1010127	ONKA-1107				
				1010128	ONKA-1108				
				1010129	ONKA-1109				



## MRK SERİSİ PABUÇ BAĞLANTILI BARALI RAY KLEMENSLER (KAPAKLI)

CİNSİ	GERİLİM / AKIM (V/A)	KUTU ADEDİ	RENK	ÜRÜN KODU	ESKİ KOD	ADET (t)
25 mm <sup>2</sup> Pabuç Bağlantılı, Baralı, Kapaklı	1000 V / 101 A	10		1030001	ONKA-2301	450,50
				1030002	ONKA-2302	
				1030003	ONKA-2303	
				1030004	ONKA-2304	
				1030005	ONKA-2305	
				1030006	ONKA-2306	
				1030007	ONKA-2307	
				1030008	ONKA-2308	
				1030009	ONKA-2309	
			35 mm <sup>2</sup> Pabuç Bağlantılı, Baralı, Kapaklı	1000 V / 125 A	10	
	1030017	ONKA-2322				
	1030018	ONKA-2323				
	1030019	ONKA-2324				
	1030020	ONKA-2325				
	1030021	ONKA-2326				
	1030022	ONKA-2327				
	1030023	ONKA-2328				
	1030024	ONKA-2329				







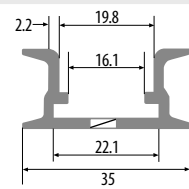
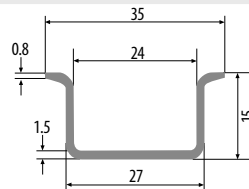
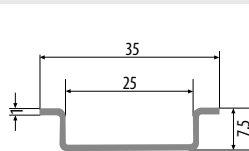



































### MONTAJ RAYI ÇEŞİTLERİ



Zemine vida ile montaj yapılabilir.



## MRK SERİSİ PABUÇ BAĞLANTILI BARALI RAY KLEMENSLER (KAPAKLI)

CİNSİ	GERİLİM / AKIM (V/A)	KUTU ADEDİ	RENK	ÜRÜN KODU	ESKİ KOD	ADET (₺)
50 mm <sup>2</sup> Pabuç Bağlantılı, Baralı, Kapaklı	1000 V / 150 A	10		1030030	ONKA-2341	540,20
				1030031	ONKA-2342	
				1030032	ONKA-2343	
				1030033	ONKA-2344	
				1030034	ONKA-2345	
				1030035	ONKA-2346	
				1030036	ONKA-2347	
				1030037	ONKA-2348	
				1030038	ONKA-2349	
			70 mm <sup>2</sup> Pabuç Bağlantılı, Baralı, Kapaklı	1000 V / 192 A	10	
	1030045	ONKA-2362				
	1030046	ONKA-2363				
	1030047	ONKA-2364				
	1030048	ONKA-2365				
	1030049	ONKA-2366				
	1030050	ONKA-2367				
	1030051	ONKA-2368				
	1030052	ONKA-2369				
95 mm <sup>2</sup> Pabuç Bağlantılı, Baralı, Kapaklı	1000 V / 232 A	10				
				1030059	ONKA-2382	
				1030060	ONKA-2383	
				1030061	ONKA-2384	
				1030062	ONKA-2385	
				1030063	ONKA-2386	
				1030064	ONKA-2387	
				1030065	ONKA-2388	
				1030066	ONKA-2389	
			120 mm <sup>2</sup> Pabuç Bağlantılı, Baralı, Kapaklı	1000 V / 269 A	5	
	1030073	ONKA-2402				
	1030074	ONKA-2403				
	1030075	ONKA-2404				
	1030076	ONKA-2405				
	1030077	ONKA-2406				
	1030078	ONKA-2407				
	1030079	ONKA-2408				
	1030080	ONKA-2409				
150 mm <sup>2</sup> Pabuç Bağlantılı, Baralı, Kapaklı	1000 V / 309 A	5				
				1030088	ONKA-2422	
				1030089	ONKA-2423	
				1030090	ONKA-2424	
				1030091	ONKA-2425	
				1030092	ONKA-2426	
				1030093	ONKA-2427	
				1030094	ONKA-2428	
				1030095	ONKA-2429	

## MRK SERİSİ PABUÇ BAĞLANTILI BARALI RAY KLEMENSLER (KAPAKLI)

CİNSİ	GERİLİM / AKIM (V/A)	KUTU ADEDİ	RENK	ÜRÜN KODU	ESKİ KOD	ADET (t)
185 mm <sup>2</sup> Pabuç Bağlantılı, Baralı, Kapaklı	1000 V / 353 A	5		1030101	ONKA-2441	2.038,60
				1030102	ONKA-2442	
				1030103	ONKA-2443	
				1030104	ONKA-2444	
				1030105	ONKA-2445	
				1030106	ONKA-2446	
				1030107	ONKA-2447	
				1030108	ONKA-2448	
				1030109	ONKA-2449	
240 mm <sup>2</sup> Pabuç Bağlantılı, Baralı, Kapaklı	1000 V / 415 A	5		1030115	ONKA-2461	2.581,80
				1030116	ONKA-2462	
				1030117	ONKA-2463	
				1030118	ONKA-2464	
				1030119	ONKA-2465	
				1030120	ONKA-2466	
				1030121	ONKA-2467	
				1030122	ONKA-2468	
				1030123	ONKA-2469	

## MRK SERİSİ PABUÇ BAĞLANTILI BARALI RAY KLEMENSLER İÇİN ÜÇGEN ETİKET









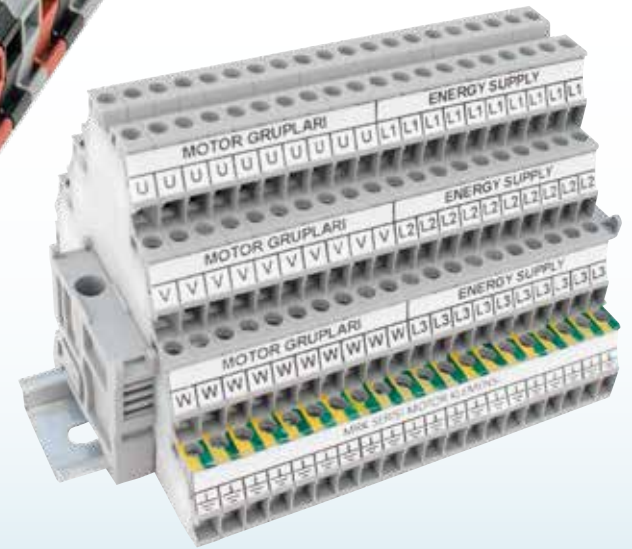
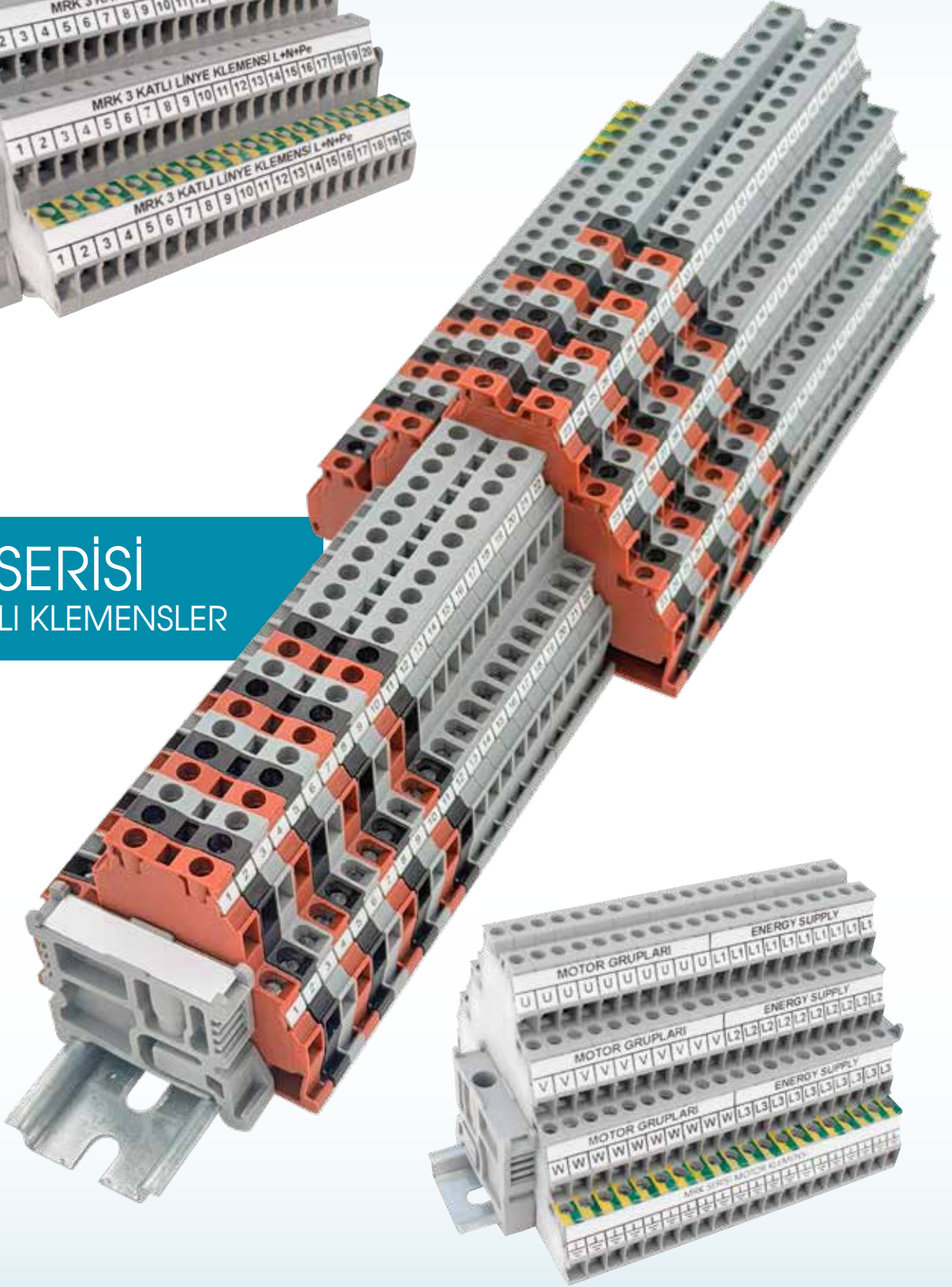

































ÜRÜN KODU	CİNSİ	ADET (t)	PLAKA ADEDİ
ONKA-2473	25 mm Üçgen Etiket (DİKKAT)	4,95 €	1 PLAKA (132 ADET)
ONKA-2474	25 mm Üçgen Etiket (NÖTR)	4,95 €	1 PLAKA (132 ADET)
ONKA-2477	25 mm Üçgen Etiket (TOPRAK)	4,95 €	1 PLAKA (132 ADET)
ONKA-2478	25 mm Üçgen Etiket (FAZ)	4,95 €	1 PLAKA 44 TAKIM (132 ADET)









































## MRK SERİSİ ÇOK KATLI KLEMENSLER



## MRK SERİSİ VİDA BAĞLANTILI İKİ KATLI RAY KLEMENSLER

CİNSİ	GERİLİM / AKIM (V/A)	KUTU ADEDİ	RENK	ÜRÜN KODU	ESKİ KOD	ADET (t)	ÜRÜN KODU (V0)	ESKİ KOD (V0)	ADET (V0) (t)		
MRK-Ç 2,5 mm <sup>2</sup>	750 V / 24 A	50		1010331	ONKA-1611	95,12			101,80		
				1010332	ONKA-1612					1010411	ONKA-0732
				1010333	ONKA-1613						
				1010334	ONKA-1614						
				1010335	ONKA-1615						
				1010336	ONKA-1616						
				1010337	ONKA-1617						
				1010338	ONKA-1618						
				1010339	ONKA-1619						
MRK-Ç 2,5 mm <sup>2</sup>	750 V / 24 A	50		1010340	ONKA-1621	138,70			139,30		
				1010341	ONKA-1622					1010407	ONKA-0482
				1010342	ONKA-1623						
				1010343	ONKA-1624						
				1010344	ONKA-1625						
				1010345	ONKA-1626						
				1010346	ONKA-1627						
				1010347	ONKA-1628						
				1010348	ONKA-1629						
MRK-Ç 2,5 mm <sup>2</sup> Diyotlu (A Yön)	750 V / 	50		1010349	ONKA-1631	237,30			244,00		
				1010350	ONKA-1632					1010406	ONKA-0402
				1010351	ONKA-1633						
				1010352	ONKA-1634						
				1010353	ONKA-1635						
				1010354	ONKA-1636						
				1010355	ONKA-1637						
				1010356	ONKA-1638						
				1010357	ONKA-1639						
MRK-Ç 2,5 mm <sup>2</sup> Diyotlu (B Yön)	750 V / 	50				237,30			244,00		
				1010585							
											
											
											
											
											
											
											
MRK-Ç 2,5 mm <sup>2</sup>	750 V / 24 A	50		1010575		177,90	1010581		182,15		
											

## MRK SERİSİ VİDA BAĞLANTILI İKİ KATLI RAY KLEMENSLER

CİNSİ	GERİLİM / AKIM (V/A)	KUTU ADEDİ	RENK	ÜRÜN KODU	ESKİ KOD	ADET (t)	ÜRÜN KODU (V0)	ESKİ KOD (V0)	ADET (V0) (t)
MRK-Ç 4 mm <sup>2</sup>	750 V / 32 A	50		1010367	ONKA-1651	105,30	1010410	ONKA-0722	111,50
				1010368	ONKA-1652				
				1010369	ONKA-1653				
				1010370	ONKA-1654				
				1010371	ONKA-1655				
				1010372	ONKA-1656				
				1010373	ONKA-1657				
				1010374	ONKA-1658				
				1010375	ONKA-1659				
MRK-Ç 4 mm <sup>2</sup>	750 V / 32 A	50		1010376	ONKA-1661	148,70	1010408	ONKA-0492	148,80
				1010377	ONKA-1662				
				1010378	ONKA-1663				
				1010379	ONKA-1664				
				1010380	ONKA-1665				
				1010381	ONKA-1666				
				1010382	ONKA-1667				
				1010383	ONKA-1668				
				1010384	ONKA-1669				
MRK-Ç 4 mm <sup>2</sup> Diyotlu (A Yön)	750 V / 	50		1010385	ONKA-1671	247,50	1010405	ONKA-0392	253,70
				1010386	ONKA-1672				
				1010387	ONKA-1673				
				1010388	ONKA-1674				
				1010389	ONKA-1675				
				1010390	ONKA-1676				
				1010391	ONKA-1677				
				1010392	ONKA-1678				
				1010393	ONKA-1679				
MRK-Ç 4 mm <sup>2</sup> Diyotlu (B Yön)	750 V / 	50				247,50			253,70
				1010586					
									
									
									
									
									
									
									
MRK-Ç 4 mm <sup>2</sup>	750 V / 32 A	50		1010576		187,45	1010582		192,25





Farklı fonksiyon türevleri için satış temsilcilerimizle iletişime geçiniz.

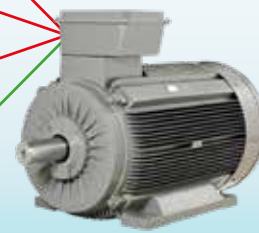
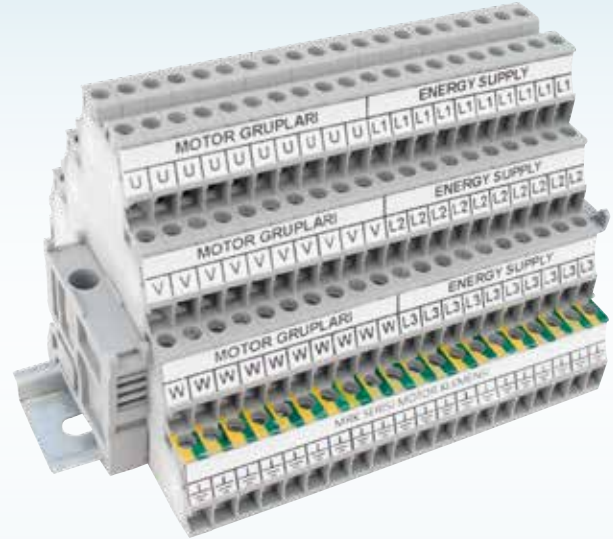
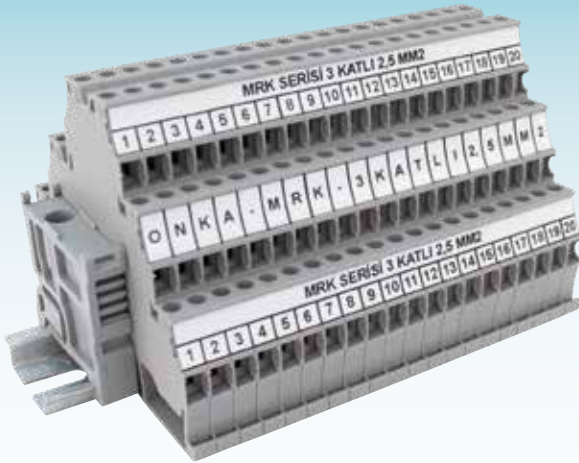

Yalnız kendi üst köprüleri ile kullanılır.

## MRK SERİSİ VİDA BAĞLANTILI MOTOR KLEMENS

CİNSİ	GERİLİM / AKIM (V/A)	KUTU ADEDİ	RENK	ÜRÜN KODU	ADET (t)	ÜRÜN KODU (V0)	ADET (V0) (t)
MRK-MT 2,5 mm <sup>2</sup>	750 V / 24 A	50	➔	1010412	318,25	1010413	331,40

### MONTAJ RAYI ÇEŞİTLERİ

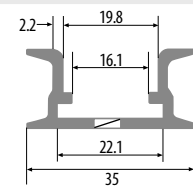
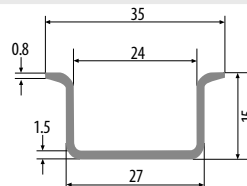
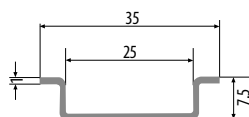

## MRK SERİSİ ÜÇ KATLI VİDA BAĞLANTILI RAY KLEMENS

CİNSİ	GERİLİM / AKIM (V/A)	KUTU ADEDİ	RENK	ÜRÜN KODU	ADET (t)	ÜRÜN KODU (V0)	ADET (V0) (t)
MRK-3K 2,5 mm <sup>2</sup>	750 V / 24 A	50	→	1010424	203,95	1010478	217,00
			→	1010425		1010479	
			→	1010426		1010480	
			→	1010427		1010481	
			→	1010428		1010482	
			→	1010429		1010483	
			→	1010430		1010484	
			→	1010431		1010485	
			→	1010432		1010486	
			MRK-3K 2,5 mm <sup>2</sup> Köprülü	750 V / 24 A		50	
→	1010434	1010488					
→	1010435	1010489					
→	1010436	1010490					
→	1010437	1010491					
→	1010438	1010492					
→	1010439	1010493					
→	1010440	1010494					
→	1010441	1010495					
MRK-3K 2,5 mm <sup>2</sup> Topraklı	750 V / 24 A	50			→		1010414
			→	1010415	367,20	1010420	
MRK-3K 2,5 mm <sup>2</sup> İçten Köprülü Topraklı	750 V / 24 A	50					

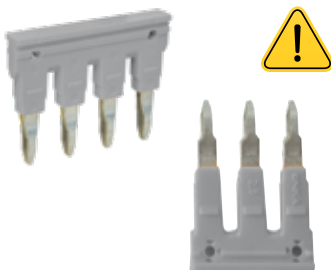

## MRK SERİSİ ÜÇ KATLI RAY KLEMENS ÜST KÖPÜLERİ



CİNSİ	RENK	ÜRÜN KODU	ADET (t)	KUTU ADEDİ
MRK Üç Katlı 2,5 mm <sup>2</sup> - 2'li Üst Köprü	→	1060206	46,50	100
MRK Üç Katlı 2,5 mm <sup>2</sup> - 3'ü Üst Köprü	→	1060207	55,50	100
MRK Üç Katlı 2,5 mm <sup>2</sup> - 4'lü Üst Köprü	→	1060208	64,00	75
MRK Üç Katlı 2,5 mm <sup>2</sup> - 10'lu Üst Köprü	→	1060209	122,20	30
MRK Üç Katlı 2,5 mm <sup>2</sup> - 20'li Üst Köprü	→	1060210	208,00	20

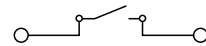

## MRK TEST KLEMENSİ (Bıçaklı Kapalı Sistem)

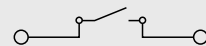
CİNSİ	GERİLİM / AKIM (V/A)	KUTU ADEDİ	RENK	ÜRÜN KODU	ESKİ KOD	ADET (t)
2,5 mm <sup>2</sup> Bıçaklı Sistem "Monoblok"	750 V / 24 A	50				
			➔	1010577	-	86,30
6 mm <sup>2</sup> Bıçaklı Sistem	750 V / 41 A	100				
			➔	1010239	ONKA-1317	117,70
			➔	1010238	ONKA-1316	











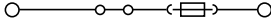









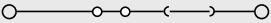

## CAM SİGORTA













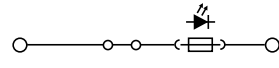



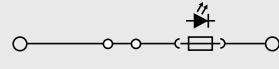



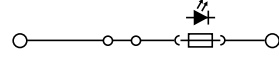

CİNSİ	ÜRÜN KODU	ADET (t)	KUTU ADEDİ
5x20 mm Cam Sigorta (0,2.....10A Sigorta Akımını Belirtiniz.)	WE-FS-52	⚡	100

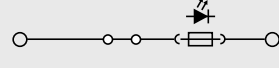
## MRK-S SERİSİ SİGORTALI RAY KLEMENSLER BARALI ve LEDLİ

CİNSİ	GERİLİM / AKIM (V/A)	KUTU ADEDİ	RENK	ÜRÜN KODU	ADET (t)
   *5x20 mm Cam Sigorta ile kullanılır.	750 V / 6,3 A	100		1010587	173,20
				1010588	
				1010589	
				1010590	
				1010591	
				1010592	
				1010593	
				1010594	
				1010595	
			 	750 V / 6,3 A	
	1010597				
	1010598				
	1010599				
	1010600				
	1010601				
	1010602				
	1010603				
	1010604				

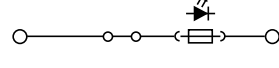
## MRK-S SERİSİ SİĞORTALI RAY KLEMENSLER BARALI ve LEDLİ

cinsi	GERİLİM / AKIM (V/A)	KUTU ADEDİ	RENK	ÜRÜN KODU	ADET (t)		
   <p><b>MRK-S 4 mm<sup>2</sup> AC/DC LED</b></p> <p><b>12 V / 6,3 A</b></p> <p><b>100</b></p> <p><b>*5x20 mm Cam Sigorta ile kullanılır.</b></p>		→	1010605	318,70			
		→	1010606				
		→	1010607				
		→	1010608				
		→	1010609				
		→	1010610				
		→	1010611				
		→	1010612				
		→	1010613				
		   <p><b>MRK-S 4 mm<sup>2</sup> AC/DC LED</b></p> <p><b>24 V / 6,3 A</b></p> <p><b>100</b></p> <p><b>*5x20 mm Cam Sigorta ile kullanılır.</b></p>			→	1010614	318,70
					→	1010615	
					→	1010616	
					→	1010617	
→	1010618						
→	1010619						
→	1010620						
→	1010621						
→	1010622						
   <p><b>MRK-S 4 mm<sup>2</sup> AC/DC LED</b></p> <p><b>48 V / 6,3 A</b></p> <p><b>100</b></p> <p><b>*5x20 mm Cam Sigorta ile kullanılır.</b></p>				→	1010623	318,70	
				→	1010624		
				→	1010625		
				→	1010626		
		→	1010627				
		→	1010628				
		→	1010629				
		→	1010630				
		→	1010631				
		   <p><b>MRK-S 4 mm<sup>2</sup> AC/DC LED</b></p> <p><b>110 V / 6,3 A</b></p> <p><b>100</b></p> <p><b>*5x20 mm Cam Sigorta ile kullanılır.</b></p>		→	1010632		318,70
				→	1010633		
				→	1010634		
				→	1010635		
→	1010636						
→	1010637						
→	1010638						
→	1010639						
→	1010640						
   <p><b>MRK-S 4 mm<sup>2</sup> AC/DC LED</b></p> <p><b>220 V / 6,3 A</b></p> <p><b>100</b></p> <p><b>*5x20 mm Cam Sigorta ile kullanılır.</b></p>				→	1010641	318,70	
				→	1010642		
				→	1010643		
				→	1010644		
		→	1010645				
		→	1010646				
		→	1010647				
		→	1010648				
		→	1010649				

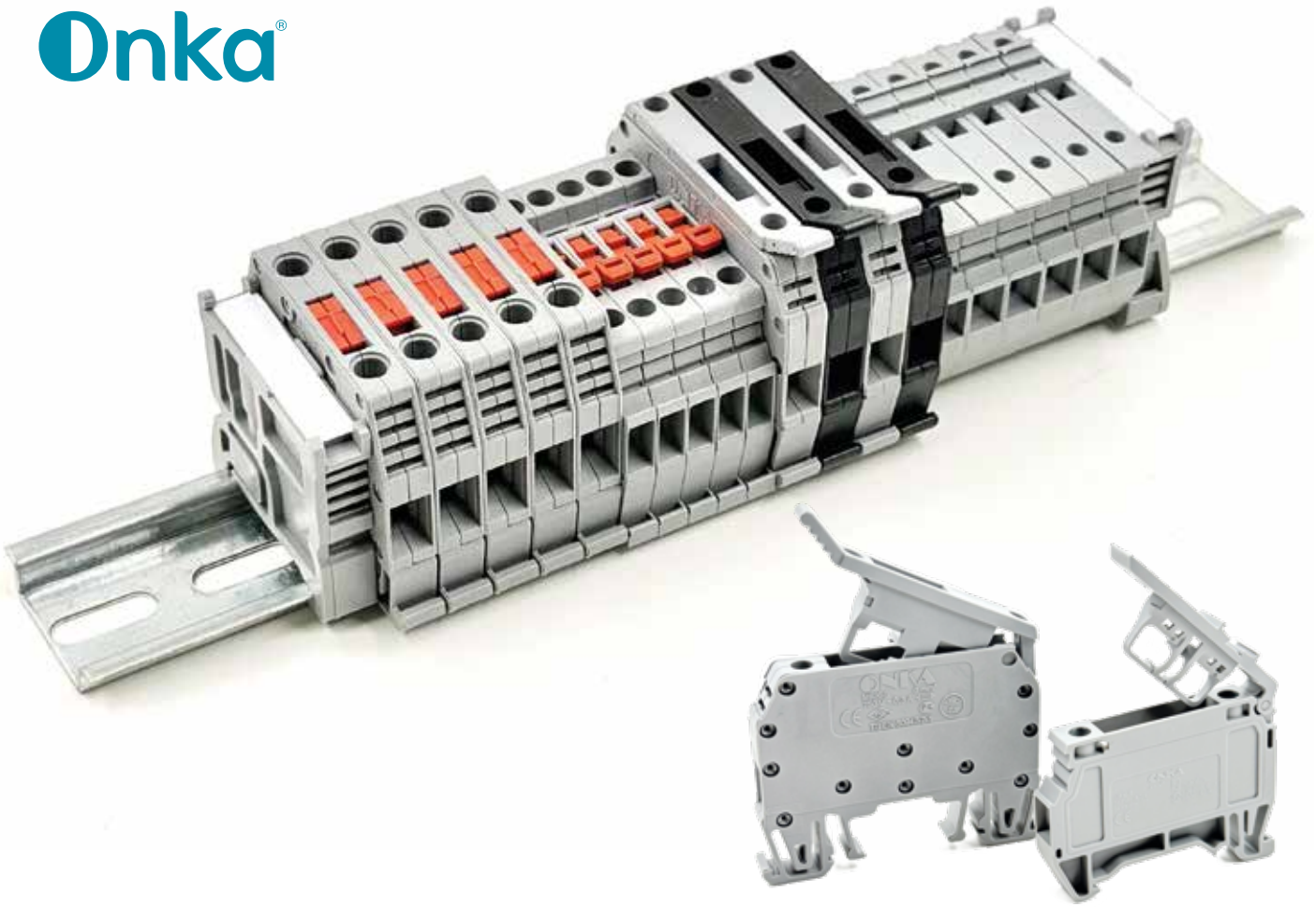





## CAM SİGORTA





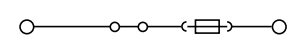

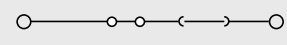



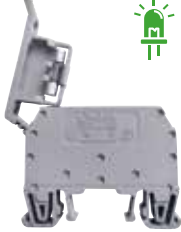
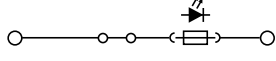











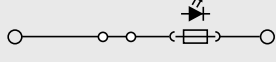









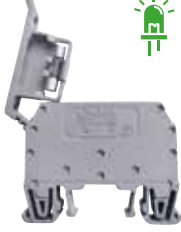
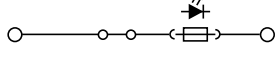











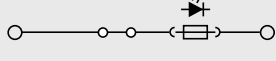











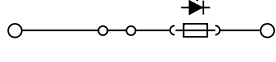

cinsi	ÜRÜN KODU	ADET (t)	KUTU ADEDİ
5x20 mm Cam Sigorta (0,2.....10A Sigorta Akımını Belirtiniz.)	WE-FS-52	⚡	100

## MRK-S SERİSİ SİGORTALI RAY KLEMENSLER BARALI ve LEDLİ

cinsi	GERİLİM / AKIM (V/A)	KUTU ADEDİ	RENK	ÜRÜN KODU	ESKİ KOD	ADET (t)
   <p>⚠ *5x20 mm Cam Sigorta ile kullanılır.</p>	750 V / 6,3 A	100	→	1010240	ONKA-1321	203,60
			→	1010241	ONKA-1322	
			→	1010242	ONKA-1323	
			→	1010243	ONKA-1324	
			→	1010244	ONKA-1325	
			→	1010245	ONKA-1326	
			→	1010246	ONKA-1327	
			→	1010247	ONKA-1328	
			→	1010248	ONKA-1329	
			  	750 V / 6,3 A	100	
→	1010250	ONKA-1332				
→	1010251	ONKA-1333				
→	1010252	ONKA-1334				
→	1010253	ONKA-1335				
→	1010254	ONKA-1336				
→	1010255	ONKA-1337				
→	1010256	ONKA-1338				
→	1010257	ONKA-1339				



## MRK-S SERİSİ SİĞORTALI RAY KLEMENSLER BARALI ve LEDLİ

cinsi	GERİLİM / AKIM (V/A)	KUTU ADEDİ	RENK	ÜRÜN KODU	ESKİ KOD	ADET (t)
    *5x20 mm Cam Sigorta ile kullanılır.	12 V / 6,3 A	100		1010258	ONKA-1341	349,10
				1010259	ONKA-1342	
				1010260	ONKA-1343	
				1010261	ONKA-1344	
				1010262	ONKA-1345	
				1010263	ONKA-1346	
				1010264	ONKA-1347	
				1010265	ONKA-1348	
				1010266	ONKA-1349	
			    *5x20 mm Cam Sigorta ile kullanılır.	24 V / 6,3 A	100	
	1010268	ONKA-1352				
	1010269	ONKA-1353				
	1010270	ONKA-1354				
	1010271	ONKA-1355				
	1010272	ONKA-1356				
	1010273	ONKA-1357				
	1010274	ONKA-1358				
	1010275	ONKA-1359				
    *5x20 mm Cam Sigorta ile kullanılır.	48 V / 6,3 A	100				
				1010286	ONKA-1372	
				1010287	ONKA-1373	
				1010288	ONKA-1374	
				1010289	ONKA-1375	
				1010290	ONKA-1376	
				1010291	ONKA-1377	
				1010292	ONKA-1378	
				1010293	ONKA-1379	
			    *5x20 mm Cam Sigorta ile kullanılır.	110 V / 6,3 A	100	
	1010304	ONKA-1392				
	1010305	ONKA-1393				
	1010306	ONKA-1394				
	1010307	ONKA-1395				
	1010308	ONKA-1396				
	1010309	ONKA-1397				
	1010310	ONKA-1398				
	1010311	ONKA-1399				
    *5x20 mm Cam Sigorta ile kullanılır.	220 V / 6,3 A	100				
				1010313	ONKA-1402	
				1010314	ONKA-1403	
				1010315	ONKA-1404	
				1010316	ONKA-1405	
				1010317	ONKA-1406	
				1010318	ONKA-1407	
				1010319	ONKA-1408	
				1010320	ONKA-1409	

## MRK ÖLÇME & AYIRMA KLEMENSİ 6 mm<sup>2</sup>



cinsi	GERİLİM / AKIM (V/A)	KUTU ADEDİ	RENK	ÜRÜN KODU	ESKİ KOD	ADET (t)
Probsuz	750 V / 41 A	50	→	1010218	ONKA-1286	215,00
			→	1010217	ONKA-1285	
			→	1010211	ONKA-1278	
Tek Test Probu	750 V / 41 A	50	→	1010214	ONKA-1282	258,30
			→	1010213	ONKA-1281	
Çift Test Probu	750 V / 41 A	50	→	1010216	ONKA-1284	302,00
			→	1010215	ONKA-1283	
			→	1010212	ONKA-1279	

## MRK ÖLÇME & AYIRMA KLEMENSİ 6 mm<sup>2</sup> AKSESUARLARI

	cinsi	ÜRÜN KODU	ESKİ KOD	ADET (t)	KUTU ADEDİ
	MRK 6 mm <sup>2</sup> - 2'li Standart Üst Köprü	1060116	ONKA-1935	70,60	100
	MRK 6 mm <sup>2</sup> - 3'lü Standart Üst Köprü	1060117	ONKA-1936	90,05	50
	MRK 6 mm <sup>2</sup> - 4'lü Standart Üst Köprü	1060118	ONKA-1937	110,80	50
	MRK 6 mm <sup>2</sup> - 10'lü Standart Üst Köprü	1060119	ONKA-1938	237,80	15
	MRK 6 mm <sup>2</sup> - 20'li Standart Üst Köprü	1060120	ONKA-1939	430,50	10
	MRK 6 mm <sup>2</sup> - 2'li Çatal Tip Üst Köprü	1060147	ONKA-1970	73,05	10
	MRK 6 mm <sup>2</sup> - 3'lü Çatal Tip Üst Köprü	1060148	ONKA-1971	93,00	10
	MRK 6 mm <sup>2</sup> - 4'lü Çatal Tip Üst Köprü	1060149	ONKA-1972	117,50	10
	MRK 6 mm <sup>2</sup> - 6'li Çatal Tip Üst Köprü	1060150	ONKA-1973	158,50	10
	MRK 6 mm <sup>2</sup> - 10'lü Çatal Tip Üst Köprü	1060151	ONKA-1974	248,00	10
	MRK 6 mm <sup>2</sup> Ölçme Ayırma Test Probu	1060073	ONKA-1280	51,90	10

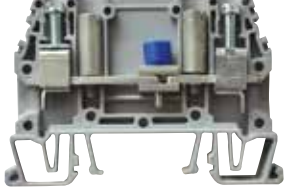

## MRK ÖLÇME & AYIRMA KLEMENSİ 10 mm<sup>2</sup>

cinsi	GERİLİM / AKIM (V/A)	KUTU ADEDİ	RENK	ÜRÜN KODU	ESKİ KOD	ADET (t)
Çift Kovanlı	750 V / 57 A	75	➔	1010236	ONKA-1312	285,80
						
Tek Test Probu	750 V / 57 A	50	➔	1010230	ONKA-1306	341,80
						
Çift Test Probu	750 V / 57 A	50	➔	1010232	ONKA-1308	481,10
						

MARKALAMA SİSTEMLERİ

DAĞITICI ÜNİTELER

W OTOMAT BARALARI VE MONTAJ RAYLARI





SIKMALI KABLO PABUÇLARI

SIRA KLEMENSİLER

KABLO VE PANO AKSESUARLARI

KABLO RAKORLARI

## MRK ÖLÇME & AYIRMA KLEMENSİ 10 mm<sup>2</sup> AKSESUARLARI

	cinsi	ÜRÜN KODU	ESKİ KOD	ADET (t)	KUTU ADEDİ
	MRK 10 mm <sup>2</sup> - 2'li Üst Köprü	1060078	ONKA-1303	57,40	50
	MRK 10 mm <sup>2</sup> - 4'li Üst Köprü	1060080	ONKA-1318	80,40	50
	MRK 10 mm <sup>2</sup> - 8'li Üst Köprü	1060077	ONKA-1302	119,00	50
	MRK 10 mm <sup>2</sup> Ölçme Ayırma Test Probu	1060081	ONKA-1319	125,70	50
	MRK 10 mm <sup>2</sup> Ölçme Ayırma Test Kovanı	1060079	ONKA-1304	64,00	50

KABLO KAVALLARI VE RAY TİPİ PRİZLER

KABLO UÇLARI

KABLO BAĞLARI VE AKSESUARLARI

DİĞER ÜRÜNLER

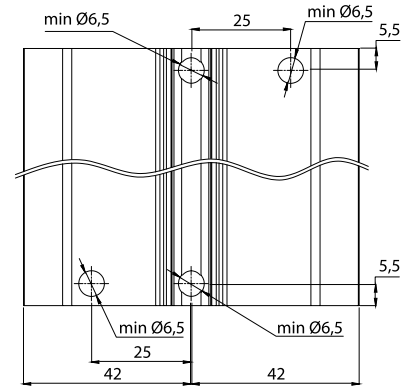
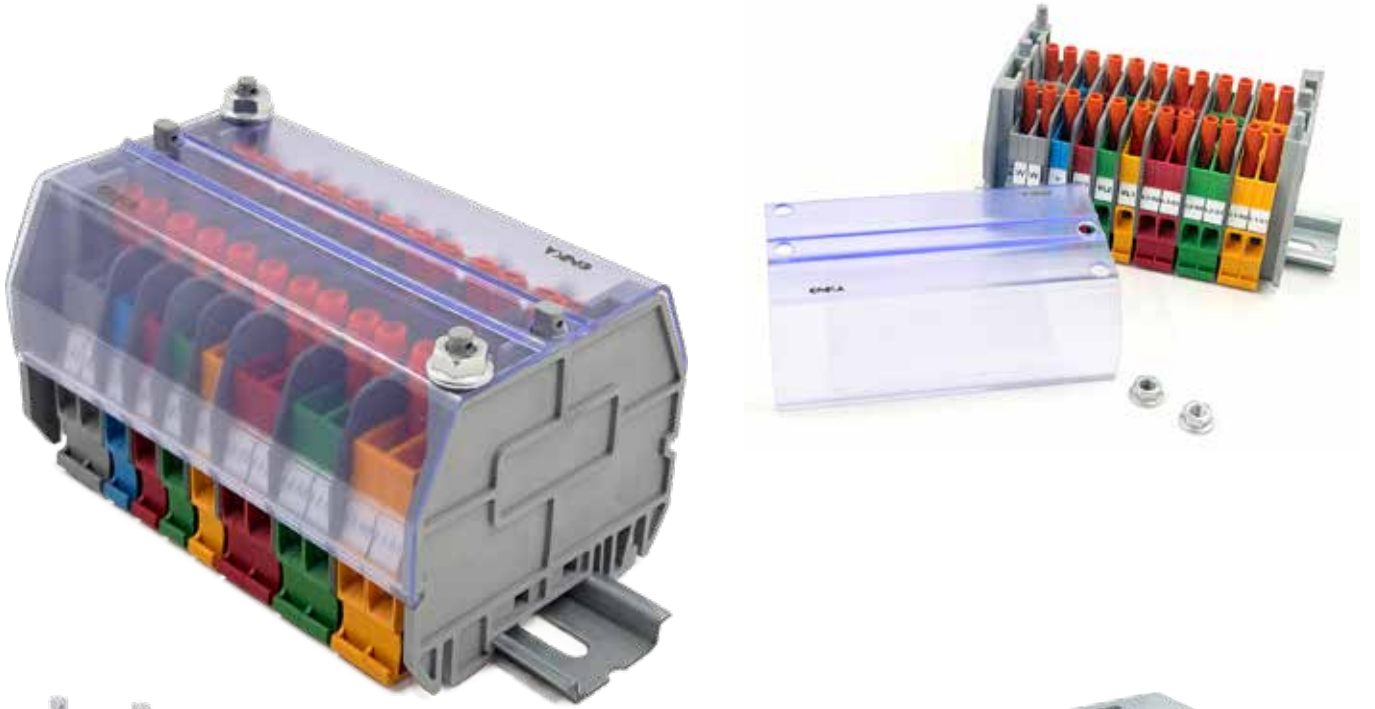

Koruma kapağı delik şablonu!

CİNSİ	ÜRÜN KODU	ADET (₺)	KUTU ADEDİ
NO:1 ŞEFFAF KAPAK PROFİLİ	ONKA-1845	430,00	8
NO:1 MÜHÜRLENEBİLİR DURDURUCU GRİ	1060535	98,45	10
NO:1 MÜHÜRLENEBİLİR METAL AYAKLI DURDURUCU GRİ	1060536	117,75	10

### MONTAJ RAYI ÇEŞİTLERİ

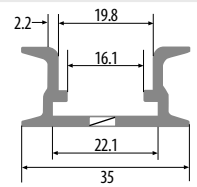
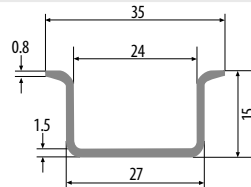
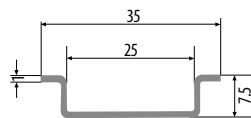

## HİBRİT BAĞLANTILI RAY KLEMENS



## YENİ HRK SERİSİ

- 2,5-6 mm<sup>2</sup> Kesit
- 10 Farklı Renk Seçeneği
- 0,34-6 mm<sup>2</sup> Aralığında Yüksüklü / Yüksüksüz, Tek Damarlı / Çok Telli (Flexible) Bağlantılar
- Renk Kodlama / Dekafix / Şerit Etiketleme olanaklarıyla evrensel markalama avantajları sağlar.
- Üst köprü imkanıyla beyan akımı dahilinde bara oluşturmak, çoklu bağlantı devreleriyle toplama ve dağıtım çözümleri elde etmek mümkündür.

## AKSESUARLAR

- 35 mm DIN Rayı
- 2,5 ve 6 mm<sup>2</sup> Üst Köprüler
- MRK ve OPK Serisi Dekafixler
- MRK ve OPK Serisi Durdurucular

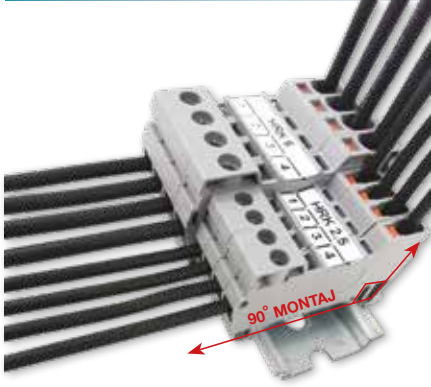

Vida ve Push-in bağlantı teknolojilerinin her ikisine de sahip bu ürün ile montör ve son kullanıcı koordinasyonunu güçlendiriyoruz.













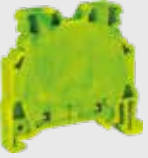



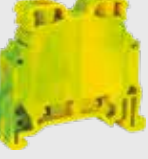

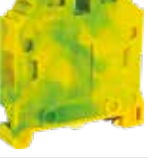
Kullanıcılar arasında, montörler için hız, operatörler için emniyetin ön planda olduğu projelerde;

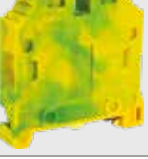
Vidalı mı / Yay bağlantılı mı? sorusunu ortadan kaldıran Hibrit ürünümüzle 60947-7-1 direktiflerinin tüm kriterlerinde üstün performans sağlarken farklı yönlerden birleşen kablolar için 90° bağlantı imkanıyla panolarınıza ergonomi ve estetik katıyoruz.



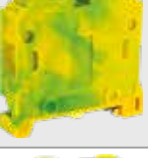

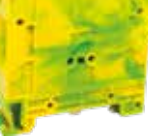



































## HİBRİT BAĞLANTILI RAY KLEMENS

Cinsi	GERİLİM / AKIM (V/A)	KUTU ADEDİ	RENK	ÜRÜN KODU	ESKİ KOD	ADET (t)	ÜRÜN KODU (V0)	ESKİ KOD (V0)	ADET (V0) (t)
HRK 2,5 mm <sup>2</sup>	750 V / 24 A	100		1040001	ONKA-0362	42,90	1040021		44,40
				1040002			1040022	ONKA-0332	
				1040003			1040023		
				1040004			1040024		
				1040005			1040025		
				1040006			1040026		
				1040007			1040027		
				1040008			1040028		
				1040009			1040029		
HRK 6 mm <sup>2</sup>	750 V / 41 A	100		1040011	ONKA-0372	80,55	1040031		83,10
				1040012			1040032	ONKA-0342	
				1040013			1040033		
				1040014			1040034		
				1040015			1040035		
				1040016			1040036		
				1040017			1040037		
				1040018			1040038		
				1040019			1040039		

## MRK SERİSİ TOPRAKLAMA KLEMENSLERİ

CİNSİ	GERİLİM (V)	RENK	ÜRÜN KODU	ESKİ KOD	ADET (t)	KUTU ADEDİ
	750 V		1010219	ONKA-1291	153,80	100
	750 V		1010220	ONKA-1293	158,45	100
	750 V		1010541	-	182,95	100
	750 V		1010221	ONKA-1294	233,25	100
	750 V		1010668	-	388,00	50
	750 V		1010532	-	553,05	50
	750 V		1010223	ONKA-1297	591,35	50
	750 V		1010533	-	608,45	30
	750 V		1010225	ONKA-1296	648,55	30



## MRK VE OPK SERİSİ DURDURUCULAR

CİNSİ	KUTU ADEDİ	RENK	ÜRÜN KODU	ESKİ KOD	ADET (t)			
Küçük Durdurucu 	100		1060013	ONKA-1221	27,40			
			1060014	ONKA-1222				
			1060015	ONKA-1223				
			1060016	ONKA-1224				
			1060017	ONKA-1225				
			1060018	ONKA-1226				
			1060019	ONKA-1227				
			1060020	ONKA-1228				
			1060021	ONKA-1229				
		Büyük Durdurucu  <b>*ONKA-8920-736SE/SB</b>	100			1060004	ONKA-1211	51,90
	1060005			ONKA-1212				
	1060006			ONKA-1213				
	1060007			ONKA-1214				
	1060008			ONKA-1215				
	1060009			ONKA-1216				
	1060010			ONKA-1217				
	1060011			ONKA-1218				
	1060012			ONKA-1219				
Grup Etiketli Durdurucu  <b>*ONKA-8920-736SE/SB</b>	100				1060023	ONKA-1231	52,40	
					1060024	ONKA-1232		
					1060025	ONKA-1233		
			1060026	ONKA-1234				
			1060027	ONKA-1235				
			1060028	ONKA-1236				
			1060029	ONKA-1237				
			1060030	ONKA-1238				
			1060031	ONKA-1239				
		Ray Klemens Grup Etiketli  <b>*ONKA-8920-736SE/SB &amp; ONKA-8943-SBG</b>	100					26,50
					1060500			
	1060501							
	1060502							
	1060503							
	1060504							
	1060505							
	1060506							
	1060507							

## MRK VE OPK SERİSİ VİDASIZ DURDURUCU VE ÜSTTEN GEÇMELİ GRUP ETİKETİ

CİNSİ	KUTU ADEDİ	RENK	ÜRÜN KODU	ESKİ KOD	ADET (t)
Vidasız Durdurucu  <b>*ONKA-8920-736SE/SB &amp; ONKA-8943-SBG</b>	100		1060001	ONKA-1201	39,40
			1060002	ONKA-1202	
			1060003	ONKA-1203	
Üstten Geçmeli Grup Etiketi 	100		1060093	ONKA-1482	8,80

## MRK SERİSİ AYIRMA PLAKASI

cinsi	KUTU ADEDİ	RENK	ÜRÜN KODU	ESKİ KOD	ADET (t)
Ayırma Plakası	25	→	1060051	ONKA-0582	23,35
		→	1060052	ONKA-0587	
MRK-OPK Yüksek Tip Ayırma Plakası	25	→	1060526	-	26,25
		→	1060527		
		→	1060528		
		→	1060529		
		→	1060530		
		→	1060531		
		→	1060532		
		→	1060533		
	→	1060534			

## MRK SERİSİ EK ALMA KLEMENSİ (Maksimum 16 mm<sup>2</sup>)

cinsi	GERİLİM / AKIM (V/A)	KUTU ADEDİ	RENK	ÜRÜN KODU	ESKİ KOD	ADET (t)
35 - 50 mm <sup>2</sup>	750 V / 76 A	100	→	1060055	ONKA-1161	130,75
			→	1060056	ONKA-1162	
			→	1060057	ONKA-1163	
			→	1060058	ONKA-1164	
			→	1060059	ONKA-1165	
			→	1060060	ONKA-1166	
			→	1060061	ONKA-1167	
			→	1060062	ONKA-1168	
			→	1060063	ONKA-1169	
70 - 95 - 120 mm <sup>2</sup>	750 V / 76 A	100	→	1060064	ONKA-1171	138,60
			→	1060065	ONKA-1172	
			→	1060066	ONKA-1173	
			→	1060067	ONKA-1174	
			→	1060068	ONKA-1175	
			→	1060069	ONKA-1176	
			→	1060070	ONKA-1177	
			→	1060071	ONKA-1178	
			→	1060072	ONKA-1179	

## MRK SERİSİ RAY KLEMENS ÜST KÖPRÜ (Vidalı)

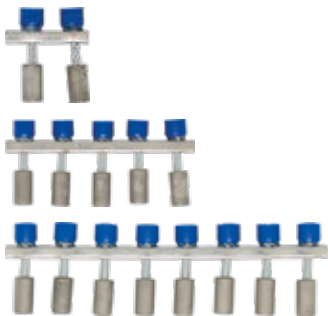

ÜRÜN AÇIKLAMASI	ÜRÜN KODU	ESKİ KOD	ADET (t)	KUTU ADEDİ
MRK 16mm <sup>2</sup> / 2 Vidalı Üst Köprü	1060152	ONKA-2257	163,40	10
MRK 16mm <sup>2</sup> / 3 Vidalı Üst Köprü	1060153	ONKA-2258	245,00	10
MRK 16mm <sup>2</sup> / 4 Vidalı Üst Köprü	1060154	ONKA-2259	326,00	10
MRK 16mm <sup>2</sup> / 5 Vidalı Üst Köprü	1060155	ONKA-2260	409,00	10
MRK 16mm <sup>2</sup> / 10 Vidalı Üst Köprü	1060160	ONKA-2265	820,00	10
MRK 35mm <sup>2</sup> / 10 Vidalı Üst Köprü	1060169	ONKA-2274	928,00	10

## MRK SERİSİ RAY KLEMENS ÜST KÖPRÜ (Geçmeli)

Köprü üzerindeki kesme kanalları sayesinde pin aralığının merkezinden kesim imkanı sağlar.

\* Bu özellik 10 Pinli ve 20 Pinli üst köprüler için geçerlidir.



Köprü üzerindeki form sayesinde tornavida ile demonte edilebilir.

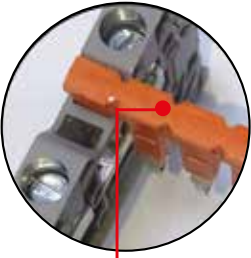

İzole gövdenin tek parça olması iletken baraya yüksek dayanıklılık sağlar.

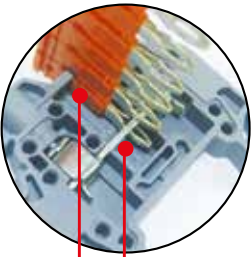

Tutucu form ile güvenli bağlantı sağlanır.

Formlu Pin yapısıyla baraya dört noktadan sürekli ve güvenli temas sağlanır.



SADECE MRK SERİSİ İLE KULLANILIR.



GİNSİ	RENK	ÜRÜN KODU	ESKİ KOD	ADET (t)	KUTU ADEDİ
1,5 x 2	→	1060101	ONKA-1920	50,65	100
1,5 x 3	→	1060102	ONKA-1921	61,10	100
1,5 x 4	→	1060103	ONKA-1922	73,30	100
1,5 x 10	→	1060104	ONKA-1923	143,55	30
1,5 x 20	→	1060105	ONKA-1924	248,60	20
2,5 x 2	→	1060106	ONKA-1925	52,90	100
2,5 x 3	→	1060107	ONKA-1926	67,75	100
2,5 x 4	→	1060108	ONKA-1927	75,40	75
2,5 x 10	→	1060109	ONKA-1928	156,50	30
2,5 x 20	→	1060110	ONKA-1929	281,80	20
4 x 2	→	1060111	ONKA-1930	56,80	100
4 x 3	→	1060112	ONKA-1931	75,40	50
4 x 4	→	1060113	ONKA-1932	82,75	50
4 x 10	→	1060114	ONKA-1933	175,00	30
4 x 20	→	1060115	ONKA-1934	305,00	20
6 x 2	→	1060116	ONKA-1935	70,60	100
6 x 3	→	1060117	ONKA-1936	90,00	50
6 x 4	→	1060118	ONKA-1937	111,00	50
6 x 10	→	1060119	ONKA-1938	237,80	15
6 x 20	→	1060120	ONKA-1939	430,50	10
10 x 2	→	1060121	ONKA-1940	76,70	100
10 x 3	→	1060122	ONKA-1941	99,00	50
10 x 4	→	1060123	ONKA-1942	118,50	50
10 x 10	→	1060124	ONKA-1943	252,50	15
10 x 20	→	1060125	ONKA-1944	500,00	10

# Onka®

11 mm  
Şerit Etiket  
Takılabilir.

**PUSH IN**



OPK  
SERİSİ

Yay Bağlantılı  
Ray Klemensler

- Push-in Sistem.
- Nihayet plakası gerektirmez. (Her iki tarafı kapalı)
- Daha iyi bir izolasyon ve maliyet avantajı sağlar.
- Daha düşük kablo itme kuvvetiyle kolay montaj.
- Zaman ve maliyet tasarrufu.
- Yalıtkan butonlar sayesinde montaj esnasında iletken kısma sıfır temas.
- Paslanmaz çelik itici yaylar.
- 0,25 mm<sup>2</sup> 'den 35 mm<sup>2</sup> 'ye kadar yüksüklü kablolarda el aleti gerektirmeden montaj imkanı.
- Renk Kodlama / Dekafix / Şerit Etiketleme olanaklarıyla evrensel markalama avantajları

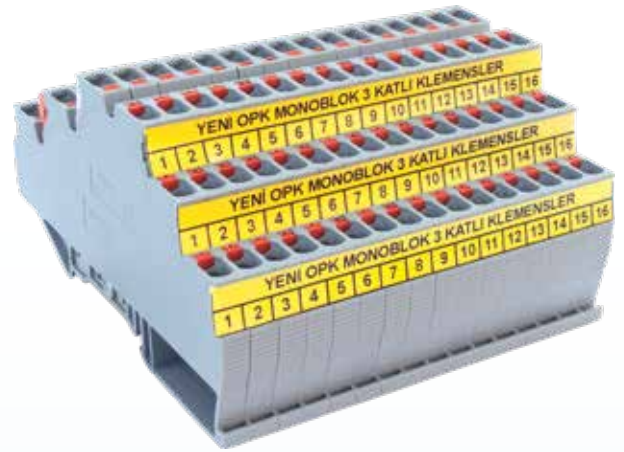





1,5 - 2,5 - 4 - 6 - 10 mm<sup>2</sup> yay baskılı push-in klemenslerde şerit markalama sistemi uygulanabilir.



Çift giriş - çift çıkış, tek giriş - çift çıkış, çift giriş - çift çıkış bıçaklı ayırma test klemenslerinde şerit markalama sistemi uygulanabilir.

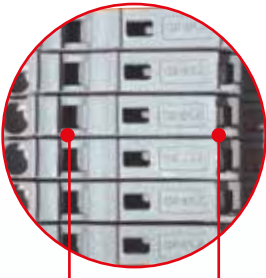
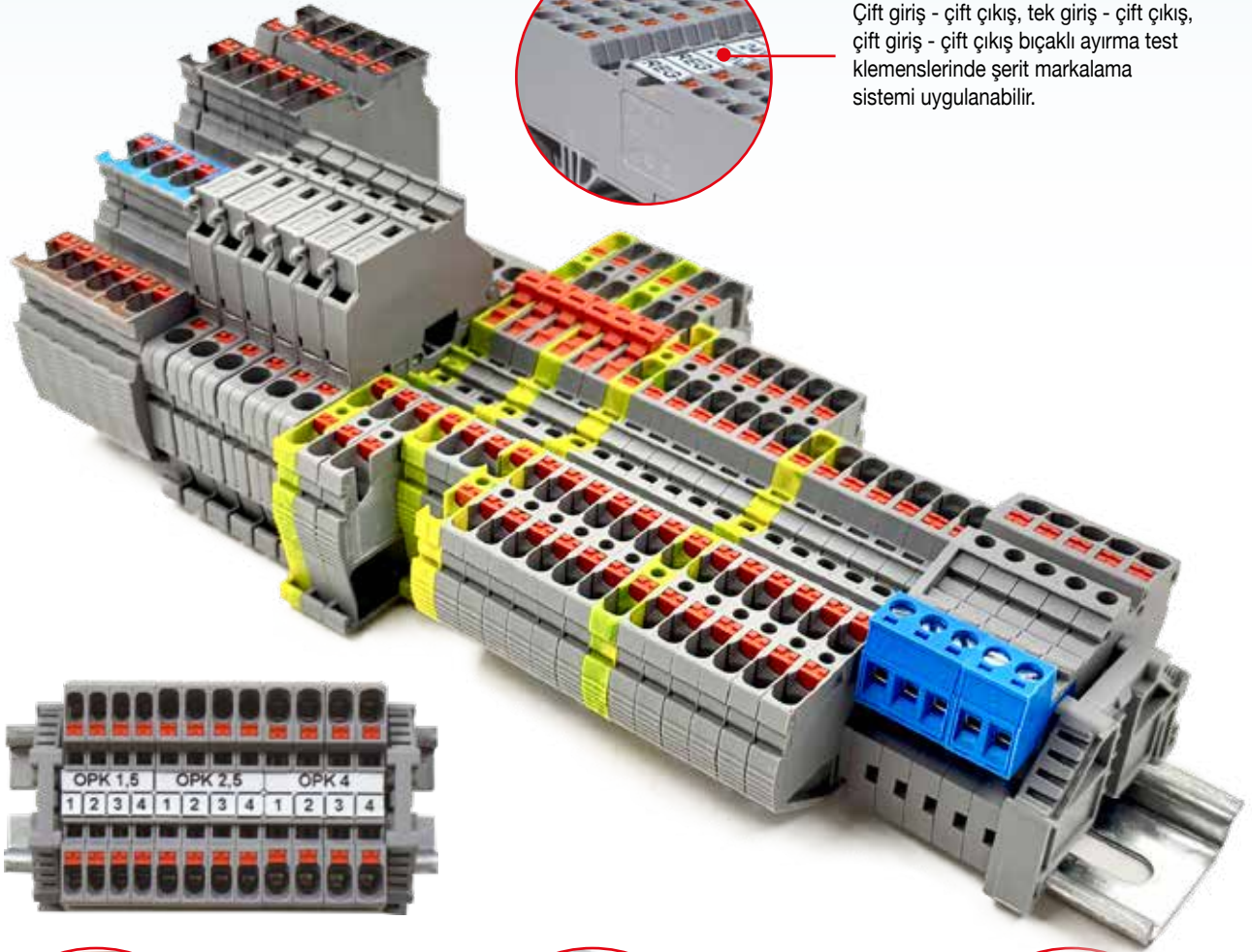

OPK sigortalı klemensde sigortanın her iki kutbu önünde bulunan ölçüm noktaları sayesinde devreyi açmadan ve sigortayı çıkartmadan muayene ve kontrol yapılabilir.



Çift yönlü köprüleme

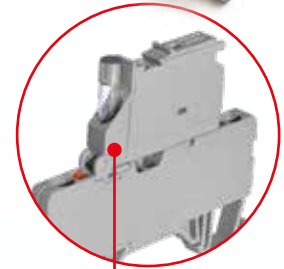

OPK Serisi sigortalı Klemenslerde yedek cam sigorta yuvası bulunmaktadır.

## MONTAJ RAYI ÇEŞİTLERİ

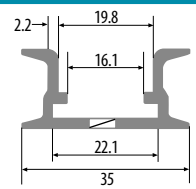
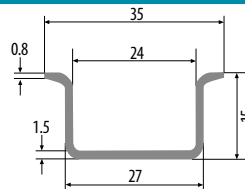
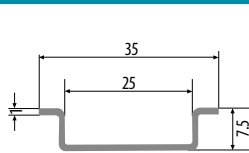

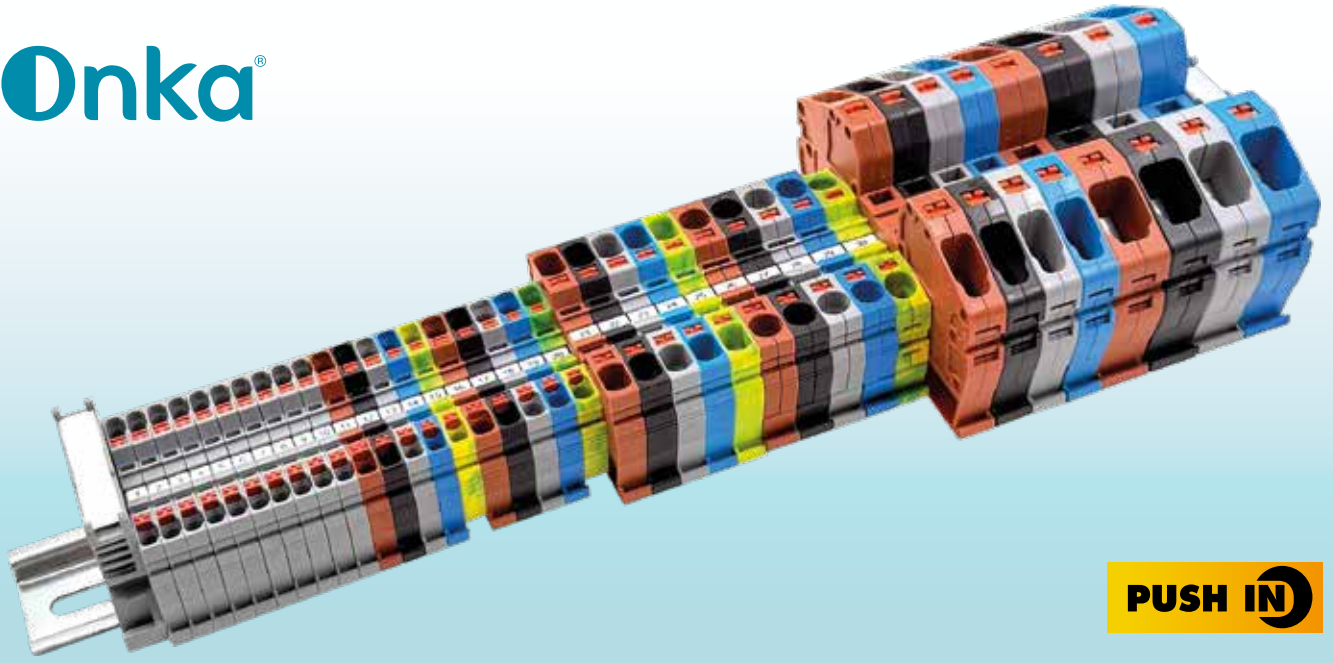

**PUSH IN**







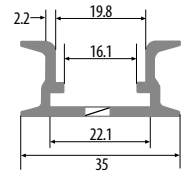
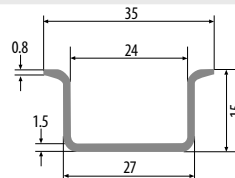
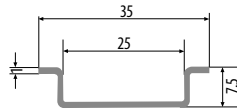









































## OPK SERİSİ YAY BAĞLANTILI RAY KLEMENSLER (PUSH-IN SİSTEM HER İKİ TARFI KAPALI)

CİNSİ	GERİLİM / AKIM (V/A)	KUTU ADEDİ	RENK	ÜRÜN KODU	ESKİ KOD	ADET (t)	ÜRÜN KODU (V0)	ESKİ KOD (V0)	ADET (V0) (t)
OPK 1,5 mm <sup>2</sup>	750 V / 17,5 A	100	→	1020001	ONKA-1591	37,70	1020073	ONKA-0531	38,60
			→	1020002	ONKA-1592		1020074	ONKA-0532	
			→	1020003	ONKA-1593		1020075	ONKA-0533	
			→	1020004	ONKA-1594		1020076	ONKA-0534	
			→	1020005	ONKA-1595		1020077	ONKA-0535	
			→	1020006	ONKA-1596		1020078	ONKA-0536	
			→	1020007	ONKA-1597		1020079	ONKA-0537	
			→	1020008	ONKA-1598		1020080	ONKA-0538	
			→	1020009	ONKA-1599		1020081	ONKA-0539	
			OPK 2,5 mm <sup>2</sup>	750 V / 24 A	100		→	1020012	
→	1020013	ONKA-1502				1020084	ONKA-0924		
→	1020014	ONKA-1503				1020085	ONKA-0925		
→	1020015	ONKA-1504				1020086	ONKA-0926		
→	1020016	ONKA-1505				1020087	ONKA-0927		
→	1020017	ONKA-1506				1020088	ONKA-0929		
→	1020018	ONKA-1507				1020089	ONKA-0930		
→	1020019	ONKA-1508				1020090	ONKA-0931		
→	1020020	ONKA-1509				1020091	ONKA-0932		
OPK 2,5 mm <sup>2</sup> Slim	750 V / 24 A	100				→	1020822	ONKA-1818	42,80
			→	1020814	ONKA-1810	1020825	ONKA-1836		
			→	1020815	ONKA-1811	1020826	ONKA-1837		
			→	1020816	ONKA-1812	1020827	ONKA-1838		
			→	1020817	ONKA-1813	1020828	ONKA-1839		
			→	1020818	ONKA-1814	1020829	ONKA-1840		
			→	1020819	ONKA-1815	1020830	ONKA-1841		
			→	1020820	ONKA-1816	1020831	ONKA-1842		
			→	1020821	ONKA-1817	1020832	ONKA-1843		

MONTAJ RAYI ÇEŞİTLERİ



## OPK SERİSİ YAY BAĞLANTILI RAY KLEMENSLER (PUSH-IN SİSTEM HER İKİ TARFI KAPALI)

CİNSİ	GERİLİM / AKIM (V/A)	KUTU ADEDİ	RENK	ÜRÜN KODU	ESKİ KOD	ADET (t)	ÜRÜN KODU (V0)	ESKİ KOD (V0)	ADET (V0) (t)
OPK 4 mm <sup>2</sup>	750 V / 32 A	100		1020023	ONKA-1511	45,20	1020089	ONKA-0931	46,30
				1020024	ONKA-1512		1020090	ONKA-0932	
				1020025	ONKA-1513				
				1020026	ONKA-1514		1020091	ONKA-0934	
				1020027	ONKA-1515		1020092	ONKA-0935	
				1020028	ONKA-1516		1020093	ONKA-0936	
				1020029	ONKA-1517		1020094	ONKA-0937	
				1020030	ONKA-1518				
				1020031	ONKA-1519		1020095	ONKA-0939	
				1020033	ONKA-1521				
OPK 6 mm <sup>2</sup>	750 V / 41 A	100		1020033	ONKA-1521	91,10	1020096	ONKA-0942	101,80
				1020034	ONKA-1522				
				1020035	ONKA-1523				
				1020036	ONKA-1524				
				1020037	ONKA-1525				
				1020038	ONKA-1526				
				1020039	ONKA-1527				
				1020040	ONKA-1528				
				1020041	ONKA-1529				
				1020043	ONKA-1531				
OPK 10 mm <sup>2</sup>	750 V / 57 A	100		1020043	ONKA-1531	136,00	1020097	ONKA-0952	142,30
				1020044	ONKA-1532				
				1020045	ONKA-1533				
				1020046	ONKA-1534				
				1020047	ONKA-1535				
				1020048	ONKA-1536				
				1020049	ONKA-1537				
				1020050	ONKA-1538				
				1020051	ONKA-1539				
				1020053	ONKA-1541				
OPK 16 mm <sup>2</sup>	750 V / 76 A	30		1020053	ONKA-1541	236,00	1020098	ONKA-0962	246,20
				1020054	ONKA-1542				
				1020055	ONKA-1543				
				1020056	ONKA-1544				
				1020057	ONKA-1545				
				1020058	ONKA-1546				
				1020059	ONKA-1547				
				1020060	ONKA-1548				
				1020061	ONKA-1549				
				1020063	ONKA-1551				
OPK 35 mm <sup>2</sup>	750 V / 125 A	20		1020063	ONKA-1551	465,00	1020099	ONKA-0972	488,15
				1020064	ONKA-1552				
				1020065	ONKA-1553				
				1020066	ONKA-1554				
				1020067	ONKA-1555				
				1020068	ONKA-1556				
				1020069	ONKA-1557				
				1020070	ONKA-1558				
				1020071	ONKA-1559				

CİNSİ	GERİLİM / AKIM (V/A)	KUTU ADEDİ	RENK	ÜRÜN KODU	ADET (t)	ÜRÜN KODU (V0)	ADET (V0) (t)
OPK-C Slim 2,5 mm <sup>2</sup> (Monoblok)	750 V / 24 A	50	→	1020870	81,50	1020906	85,60
			→	1020871		1020907	
			→	1020872		1020908	
			→	1020873		1020909	
			→	1020874		1020910	
			→	1020875		1020911	
			→	1020876		1020912	
			→	1020877		1020913	
			→	1020878		1020914	
			OPK-C Slim 2,5 mm <sup>2</sup> (Monoblok) İçten Köprülü	750 V / 24 A		50	
→	1020880	1020916					
→	1020881	1020917					
→	1020882	1020918					
→	1020883	1020919					
→	1020884	1020920					
→	1020885	1020921					
→	1020886	1020922					
→	1020887	1020923					
OPK-C Slim 2,5 mm <sup>2</sup> (Monoblok) Diyotlu A Yönlü	750 V / 1A	50			→		1020888
			→	1020889	1020925		
			→	1020890	1020926		
			→	1020891	1020927		
			→	1020892	1020928		
			→	1020893	1020929		
			→	1020894	1020930		
			→	1020895	1020931		
			→	1020896	1020932		
			OPK-C Slim 2,5 mm <sup>2</sup> (Monoblok) Diyotlu B Yönlü	750 V / 1A	50	→	1020897
→	1020898	1020934					
→	1020899	1020935					
→	1020900	1020936					
→	1020901	1020937					
→	1020902	1020938					
→	1020903	1020939					
→	1020904	1020940					
→	1020905	1020941					
OPK-C Slim 2,5 mm <sup>2</sup> (Monoblok) Pe-Pe (İçten Köprülü)	750 V / 24 A	50				→	1020943

## OPK SERİSİ YAY BAĞLANTILI MONOBLOK İKİ KATLI (DOUBLE) KLEMENSLER

 2,5 mm<sup>2</sup>

CİNSİ	GERİLİM / AKIM (V/A)	KUTU ADEDİ	RENK	ÜRÜN KODU	ADET (t)	ÜRÜN KODU (V0)	ADET (V0) (t)
OPK-C 2,5 mm <sup>2</sup> (Monoblok)	750 V / 24 A	50		1020440	91,30	1020467	95,80
				1020441		1020468	
				1020442		1020469	
				1020443		1020470	
				1020444		1020471	
				1020445		1020472	
				1020446		1020473	
				1020447		1020474	
				1020448		1020475	
			OPK-C 2,5 mm <sup>2</sup> (Monoblok) İçten Köprülü	750 V / 24 A		50	
	1020450	1020477					
	1020451	1020478					
	1020452	1020479					
	1020453	1020480					
	1020454	1020481					
	1020455	1020482					
	1020456	1020483					
	1020457	1020484					
OPK-C 2,5 mm <sup>2</sup> (Monoblok) Diyotlu A Yönlü	750 V /	50					1020458
				1020459	1020486		
				1020460	1020487		
				1020461	1020488		
				1020462	1020489		
				1020463	1020490		
				1020464	1020491		
				1020465	1020492		
				1020466	1020493		
			OPK-C 2,5 mm <sup>2</sup> (Monoblok) Diyotlu B Yönlü	750 V /	50		
	1020863						
OPK-C 2,5 mm <sup>2</sup> (Monoblok) Pe-Pe (İçten Köprülü)	750 V / 24 A	50					1020433

MARKALAMA SİSTEMLERİ

DAĞITICI ÜNİTELER

W OTOMAT BARALARI VE MONTAJ RAYLARI

SIKMALI KABLO PABUÇLARI

SIRA KLEMENSLER

KABLO VE PANO AKSESUARLARI

KABLO RAKORLARI

KABLO KANALLARI VE RAY TİPİ PRİZLER

KABLO UÇLARI

KABLO BAĞLARI VE AKSESUARLARI

DİĞER ÜRÜNLER

## OPK SERİSİ YAY BAĞLANTILI MONOBLOK İKİ KATLI (DOUBLE) KLEMENSLER

4 mm<sup>2</sup>

CİNSİ	GERİLİM / AKIM (V/A)	KUTU ADEDİ	RENK	ÜRÜN KODU	ADET (t)	ÜRÜN KODU (V0)	ADET (V0) (t)
OPK-C 4 mm <sup>2</sup> (Monoblok)	750 V / 32 A	50		1020494	95,20	1020521	100,40
				1020495		1020522	
				1020496		1020523	
				1020497		1020524	
				1020498		1020525	
				1020499		1020526	
				1020500		1020527	
				1020501		1020528	
				1020502		1020529	
			OPK-C 4 mm <sup>2</sup> (Monoblok) İçten Köprülü	750 V / 32 A		50	
	1020504	1020531					
	1020505	1020532					
	1020506	1020533					
	1020507	1020534					
	1020508	1020535					
	1020509	1020536					
	1020510	1020537					
	1020511	1020538					
OPK-C 4 mm <sup>2</sup> (Monoblok) Diyotlu A Yönlü	750 V /	50					1020512
				1020513	1020540		
				1020514	1020541		
				1020515	1020542		
				1020516	1020543		
				1020517	1020544		
				1020518	1020545		
				1020519	1020546		
				1020520	1020547		
			OPK-C 4 mm <sup>2</sup> (Monoblok) Diyotlu B Yönlü	750 V /	50		
	1020864						
OPK-C 4 mm <sup>2</sup> (Monoblok) Pe-Pe (İçten Köprülü)	750 V / 32 A	50					1020437

## OPK SERİSİ YAY BAĞLANTILI İKİ KATLI (DOUBLE) KLEMENSLER

CİNSİ	GERİLİM / AKIM (V/A)	KUTU ADEDİ	RENK	ÜRÜN KODU	ESKİ KOD	ADET (₺)	ÜRÜN KODU (V0)	ESKİ KOD (V0)	ADET (V0) (₺)			
OPK-C 2,5 mm <sup>2</sup>	750 V / 24 A	50		1020100	ONKA-1781	93,50			99,50			
				1020101	ONKA-1782					1020210	ONKA-0702	
				1020102	ONKA-1783							
				1020103	ONKA-1784					1020562		
				1020104	ONKA-1785							
				1020105	ONKA-1786					1020561		
				1020106	ONKA-1787					1020211	ONKA-0707	
				1020107	ONKA-1788							
				1020108	ONKA-1789							
OPK-C 2,5 mm <sup>2</sup> İçten Köprülü	750 V / 24 A	50		1020109	ONKA-2571	124,00		1020215	ONKA-0472	129,50		
				1020110	ONKA-2572							
				1020111	ONKA-2573							
				1020112	ONKA-2574							
				1020113	ONKA-2575							
				1020114	ONKA-2576							
				1020115	ONKA-2577							
				1020116	ONKA-2578							
				1020117	ONKA-2579							
OPK-C 2,5 mm <sup>2</sup> Diyotlu A Yönlü	750 V /	50		1020118	ONKA-2581	233,50		1020214	ONKA-0462	240,00		
				1020119	ONKA-2582							
				1020120	ONKA-2583							
				1020121	ONKA-2584							
				1020122	ONKA-2585							
				1020123	ONKA-2586							
				1020124	ONKA-2587							
				1020125	ONKA-2588							
				1020126	ONKA-2589							
OPK-C 4 mm <sup>2</sup>	750 V / 32 A	50		1020127	ONKA-1791	97,00		1020209	ONKA-0691	102,50		
				1020128	ONKA-1792							
				1020129	ONKA-1793							
				1020130	ONKA-1794							
				1020131	ONKA-1795							
				1020132	ONKA-1796							
				1020133	ONKA-1797							
				1020134	ONKA-1798							
				1020135	ONKA-1799							
OPK-C 4 mm <sup>2</sup> İçten Köprülü	750 V / 32 A	50		1020136	ONKA-2591	127,00		1020213	ONKA-0451	132,50		
				1020137	ONKA-2592							
				1020138	ONKA-2593							
				1020139	ONKA-2594							
				1020140	ONKA-2595							
				1020141	ONKA-2596							
				1020142	ONKA-2597							
				1020143	ONKA-2598							
				1020144	ONKA-2599							
OPK-C 4 mm <sup>2</sup> Diyotlu A Yönlü	750 V /	50		1020145	ONKA-2601	237,00		1020212	ONKA-0441	242,00		
				1020146	ONKA-2602							
				1020147	ONKA-2603							
				1020148	ONKA-2604							
				1020149	ONKA-2605							
				1020150	ONKA-2606							
				1020151	ONKA-2607							
				1020152	ONKA-2608							
				1020153	ONKA-2609							



## OPK SERİSİ YAY BAĞLANTILI MONOBLOK ÜÇ KATLI (TRIPLE) KLEMENSLER

Cinsi	GERİLİM / AKIM (V/A)	KUTU ADEDİ	RENK	ÜRÜN KODU	ADET (t)	ÜRÜN KODU (VO)	ADET (VO) (t)
OPK-3K 2,5 mm <sup>2</sup> (Monoblok)	750 V / 24 A	50		1020564	267,50	1020682	280,20
				1020565		1020683	
				1020566		1020684	
				1020567		1020685	
				1020568		1020686	
				1020569		1020687	
				1020570		1020688	
				1020571		1020689	
				1020572		1020690	
			OPK-3K 2,5 mm <sup>2</sup> İçten Köprülü	750 V / 24 A		50	
	1020583	1020692					
	1020584	1020693					
	1020585	1020694					
	1020586	1020695					
	1020587	1020696					
	1020588	1020697					
	1020589	1020698					
	1020590	1020699					
OPK-3K 2,5 mm <sup>2</sup> Topraklı	750 V / 24 A	50					1020627
				1020628	403,35	1020737	414,85
OPK-3K 2,5 mm <sup>2</sup> İçten Köprülü Topraklı	750 V / 24 A	50					

Topraklı

Köprülü Topraklı



## OPK SERİSİ YAY BAĞLANTILI MONOBLOK ÜÇ KATLI (TRIPLE) KLEMENSLER

CİNSİ	GERİLİM / AKIM (V/A)	KUTU ADEDİ	RENK	ÜRÜN KODU	ADET (t)	ÜRÜN KODU (V0)	ADET (V0) (t)
OPK-3K 4 mm <sup>2</sup>	750 V / 32 A	50		1020573	288,40	1020741	302,50
				1020574		1020742	
				1020575		1020743	
				1020576		1020744	
				1020577		1020745	
				1020578		1020746	
				1020579		1020747	
				1020580		1020748	
				1020581		1020749	
			OPK-3K 4 mm <sup>2</sup> İçten Köprülü	750 V / 24 A		50	
	1020633	1020751					
	1020634	1020752					
	1020635	1020753					
	1020636	1020754					
	1020637	1020755					
	1020638	1020756					
	1020639	1020757					
	1020640	1020758					
OPK-3K 4 mm <sup>2</sup> Topraklı	750 V / 32 A	50					1020677
OPK-3K 4 mm <sup>2</sup> İçten Köprülü Topraklı	750 V / 32 A	50		1020678	425,25	1020796	437,80





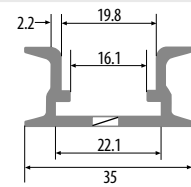
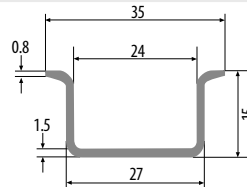
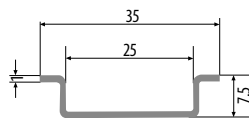

Farklı fonksiyon türevleri için satış temsilcilerimizle iletişime geçiniz.

### MONTAJ RAYI ÇEŞİTLERİ

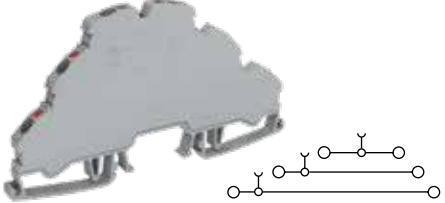

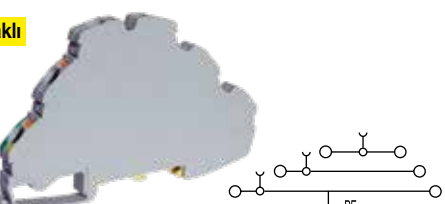
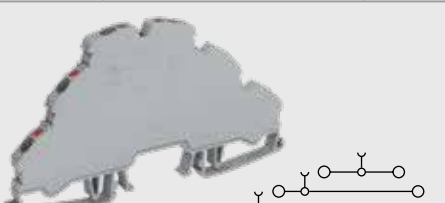
## OPK SERİSİ YAY BAĞLANTILI ÜÇ KATLI (TRIPLE) KLEMENSLER

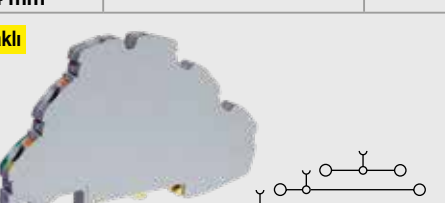
CİNSİ	GERİLİM / AKIM (V/A)	KUTU ADEDİ	RENK	ÜRÜN KODU	ESKİ KOD	ADET (t)	ÜRÜN KODU (V0)	ESKİ KOD (V0)	ADET (V0) (t)
OPK-3K 2,5 mm <sup>2</sup> 	750 V / 24 A	50	→	1020154	ONKA-1851	259,85	1020216	ONKA-0682	271,00
			→	1020155	ONKA-1852				
			→	1020156	ONKA-1853				
			→	1020157	ONKA-1854				
			→	1020158	ONKA-1855				
			→	1020159	ONKA-1856				
			→	1020160	ONKA-1857				
			→	1020161	ONKA-1858				
			→	1020162	ONKA-1859				
OPK-3K 2,5 mm <sup>2</sup> İçten Köprülü 	750 V / 24 A	50	→	1020163	ONKA-1861	318,45	1020218	ONKA-0432	329,65
			→	1020164	ONKA-1862				
			→	1020165	ONKA-1863				
			→	1020166	ONKA-1864				
			→	1020167	ONKA-1865				
			→	1020168	ONKA-1866				
			→	1020169	ONKA-1867				
			→	1020170	ONKA-1868				
			→	1020171	ONKA-1869				
OPK-3K 2,5 mm <sup>2</sup> Topraklı 	750 V / 24 A	50	→	1020174	ONKA-1872	377,00	1020219	ONKA-0672	388,25
			→	1020174	ONKA-1872				
OPK-3K 4 mm <sup>2</sup> 	750 V / 32 A	50	→	1020182	ONKA-1881	280,00	1020217	ONKA-0683	292,00
			→	1020183	ONKA-1882				
			→	1020184	ONKA-1883				
			→	1020185	ONKA-1884				
			→	1020186	ONKA-1885				
			→	1020187	ONKA-1886				
			→	1020188	ONKA-1887				
			→	1020189	ONKA-1888				
			→	1020190	ONKA-1889				
OPK-3K 4 mm <sup>2</sup> İçten Köprülü 	750 V / 32 A	50	→	1020191	ONKA-1891	338,20	1020221	ONKA-0422	350,60
			→	1020192	ONKA-1892				
			→	1020193	ONKA-1893				
			→	1020194	ONKA-1894				
			→	1020195	ONKA-1895				
			→	1020196	ONKA-1896				
			→	1020197	ONKA-1897				
			→	1020198	ONKA-1898				
			→	1020199	ONKA-1899				
OPK-3K 4 mm <sup>2</sup> Topraklı 	750 V / 32 A	50	→	1020201	ONKA-1902	397,30	1020220	ONKA-0412	409,75
			→	1020201	ONKA-1902				

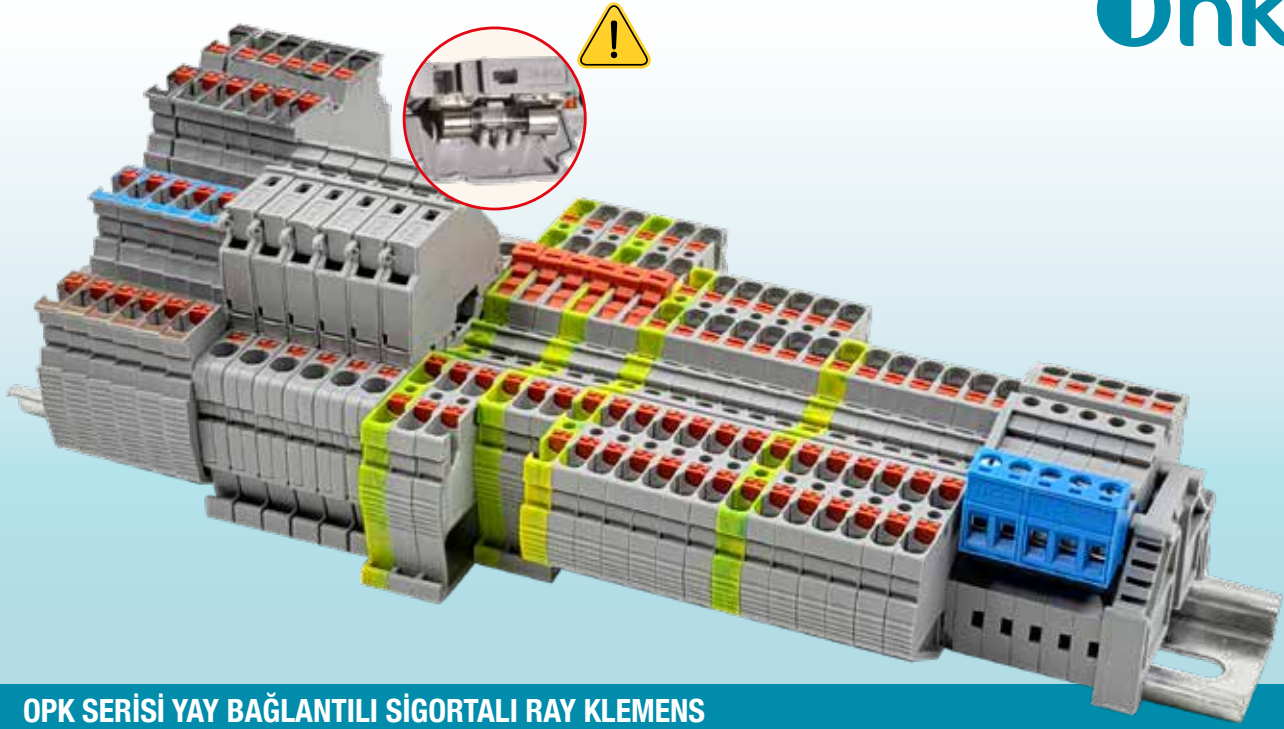

## OPK SERİSİ YAY BAĞLANTILI SİGORTALI RAY KLEMENS

cinsi	GERİLİM / AKIM (V/A)	KUTU ADEDİ	RENK	ÜRÜN KODU	ESKİ KOD	ADET (t)
OPK-S 2,5 mm <sup>2</sup>	750 V / 6,3 A	50	→	1020222	ONKA-2481	268,65
			→	1020223	ONKA-2482	
			→	1020224	ONKA-2483	
			→	1020225	ONKA-2484	
			→	1020226	ONKA-2485	
			→	1020227	ONKA-2486	
			→	1020228	ONKA-2487	
			→	1020229	ONKA-2488	
			→	1020230	ONKA-2489	
			OPK-S 2,5 mm <sup>2</sup> Baralı	750 V / 6,3 A	50	
→	1020232	ONKA-2492				
→	1020233	ONKA-2493				
→						
→						
→	1020234	ONKA-2497				
→						

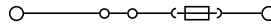

\*5x20 mm Cam Sigorta ile kullanılır.

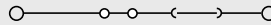

## CAM SİGORTA







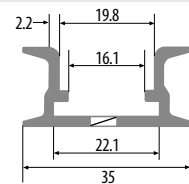
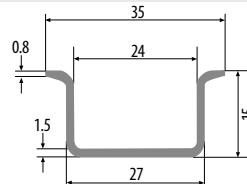
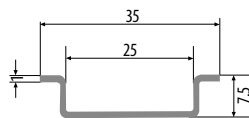



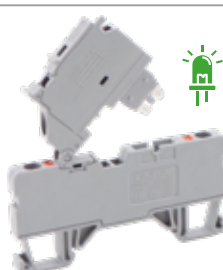









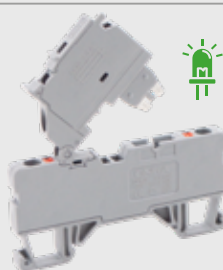







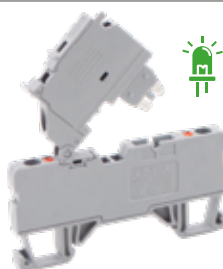









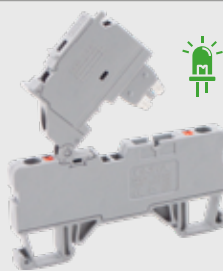









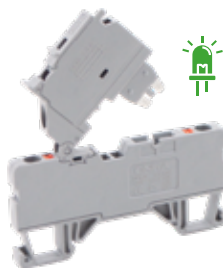

cinsi	ÜRÜN KODU	ADET (t)	KUTU ADEDİ
5x20 mm Cam Sigorta (0,2.....10A Sigorta Akımını Belirtiniz.)	WE-FS-52	⚡	100

## MONTAJ RAYI ÇEŞİTLERİ





## OPK SERİSİ YAY BAĞLANTILI SİGORTALI RAY KLEMENS

cinsi	GERİLİM / AKIM (V/A)	KUTU ADEDİ	RENK	ÜRÜN KODU	ESKİ KOD	ADET (t)
	<b>12 V / 6,3 A</b>	<b>50</b>		<b>1020235</b>	ONKA-2501	<b>388,65</b>
				<b>1020236</b>	ONKA-2502	
				<b>1020237</b>	ONKA-2503	
				<b>1020238</b>	ONKA-2504	
				<b>1020239</b>	ONKA-2505	
				<b>1020240</b>	ONKA-2506	
				<b>1020241</b>	ONKA-2507	
				<b>1020242</b>	ONKA-2508	
				<b>1020243</b>	ONKA-2509	
				<b>24 V / 6,3 A</b>	<b>50</b>	
	<b>1020245</b>	ONKA-2512				
	<b>1020246</b>	ONKA-2513				
	<b>1020247</b>	ONKA-2514				
	<b>1020248</b>	ONKA-2515				
	<b>1020249</b>	ONKA-2516				
	<b>1020250</b>	ONKA-2517				
	<b>1020251</b>	ONKA-2518				
	<b>1020252</b>	ONKA-2519				
	<b>48 V / 6,3 A</b>	<b>50</b>				
				<b>1020254</b>	ONKA-2532	
					ONKA-2533	
					ONKA-2534	
					ONKA-2535	
					ONKA-2536	
					ONKA-2537	
					ONKA-2538	
					ONKA-2539	
				<b>110 V / 6,3 A</b>	<b>50</b>	
	<b>1020256</b>	ONKA-2552				
		ONKA-2553				
		ONKA-2554				
		ONKA-2555				
		ONKA-2556				
		ONKA-2557				
		ONKA-2558				
		ONKA-2559				
	<b>220 V / 6,3 A</b>	<b>50</b>				
				<b>1020258</b>	ONKA-2562	
					ONKA-2563	
					ONKA-2564	
				<b>1020259</b>	ONKA-2565	
				<b>1020260</b>	ONKA-2566	
					ONKA-2567	
					ONKA-2568	
					ONKA-2569	

## OPK SERİSİ SENSÖR KLEMENSLERİ

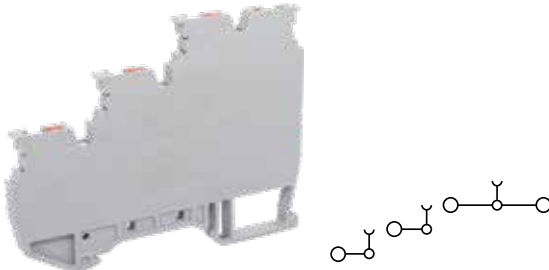
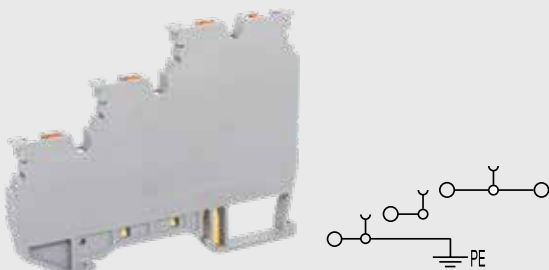
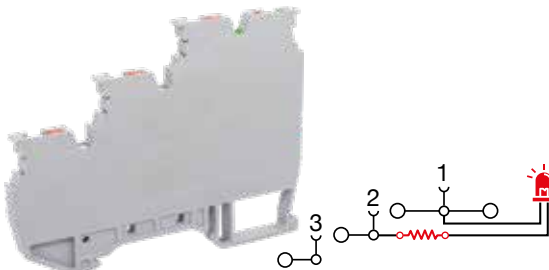
 1,5 mm<sup>2</sup>

CİNSİ	KUTU ADEDİ	RENK	ÜRÜN KODU	ADET (₺)	ÜRÜN KODU (V0)	ADET (V0) (₺)
<b>OPK 1,5 mm<sup>2</sup> SENSÖR KLEMENSİ</b> Üç İletkenli	20					
		➔	1020846	166,10	1020847	177,70
<b>OPK 1,5 mm<sup>2</sup> TOPRAKLI SENSÖR KLEMENSİ</b> Üç İletkenli, Topraklı	20					
<b>Topraklı</b> 		➔	1020848	230,00	1020849	243,60
<b>OPK 1,5 mm<sup>2</sup> PNP SENSÖR KLEMENSİ</b> Üç İletkenli, 1-2. Katlar Devre	20					
		➔	1020850	490,00	1020851	504,30
<b>OPK 1,5 mm<sup>2</sup> NPN SENSÖR KLEMENSİ</b> Üç İletkenli, 1-3. Katlar Devre	20					
		➔	1020852	490,00	1020853	504,30

### MONTAJ RAYI ÇEŞİTLERİ

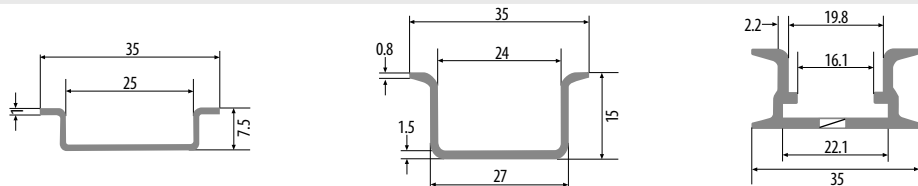

## ELEKTRONİK DEVRELİ KLEMENSLER

### 600 Ters Akım Koruma

### Bobin Ters Akım Koruma 601



**Özelliği:** DC Gerilimlerde bobin devrelerinde akımın ters gelmesini engeller. Herhangi bir kontaktör, röle, valf eğer DC akımda kullanılıyor ise bu bobin devrelerinin elektriklerini kestiğimiz anda 1000 V civarına ulaşabilecek ters EMK voltaj oluşabilmektedir. Bu zıt EMK 'da bobinden önceki devreye oldukça zarar verebilir. Bu olay DC akımda kullanılan bobinler için geçerlidir.



### 602 Lamba Test Kartları

### İki Kanallı Diyot Modül 603



**Özelliği:** Sinyal devrelerinde lambaların sağlam olup olmadığını kontrol eder. Elektrik panolarında kullanılan sinyal lambaları veya büyük tesislerde kullanılan mimik diyagramlardaki led aydınlatmalar bizlere herhangi bir sistemin çalıştığını veya arızası olduğunu bildirirler. Ancak ampullerinin patlaması veya led'in bozulması durumunda tesisdeki büyük bir arıza durumunu göremeyebiliriz. O yüzden bu lambaların belli aralıklarla sağlamlığının test edilmesi gerekmektedir. Lamba test olarak kullanılan kartlar bu test işlemini bir buton üzerinden sistemi bozmadan yapmamıza olanak tanır.



### 604 - 605 Gerilim Göstergeleri



**Özelliği:** Yapılan elektrik sistemlerindeki voltaj VAR/YOK durumunu izler. Üzerinde bulunan LED ışık sayesinde bağlı bulunduğu elektrik sistemindeki gerilimin var olup olmadığını gösterir.

### 607 - 608 - 609 - 610 Aşırı Gerilim Koruma (30 VAC-75 VAC-130 VAC-275 VAC)



**Özelliği :** Varistör üzerindeki gerilime duyarlı olan bir dirençtir. Üzerindeki gerilimle ters orantılı olarak direnci değişir. Bu yüzden korunacak olan devre veya elemana paralel olarak bağlanır. Gerilim 30 V geçtiği zaman devreyi kısa devre ederek ona bağlı olan sigortanın atmasını sağlar.

### 606 Ters Akım Korumalı Gerilim Göstergeleri



**Özelliği:** Bağlandığı yerdeki 24 VDC gerilimi led vasıtası ile var/yok olarak gösterir. Aynı zamanda içerisindeki diyot ile bobini ters akımdan korur.

### 611 - 612 - 613 Gerilim Göstergesi ve Doğrultma (Devresi 24-110-220 VAC)



**Özelliği:** 1 ve 2 numaralı klemenslerden uygulanan AC (Alternatif akım) diyotların köprü bağlantısı ile DC (Doğru Akım) şekline dönerek 3-4 klemenslerinden kullanıcıya verilir. Bu dönüşümün yapılabildiği LED göstergesi ile anlaşılır. Bir amperlik köprü diyottur.

## ELEKTRONİK DEVRELİ KLEMENSLER

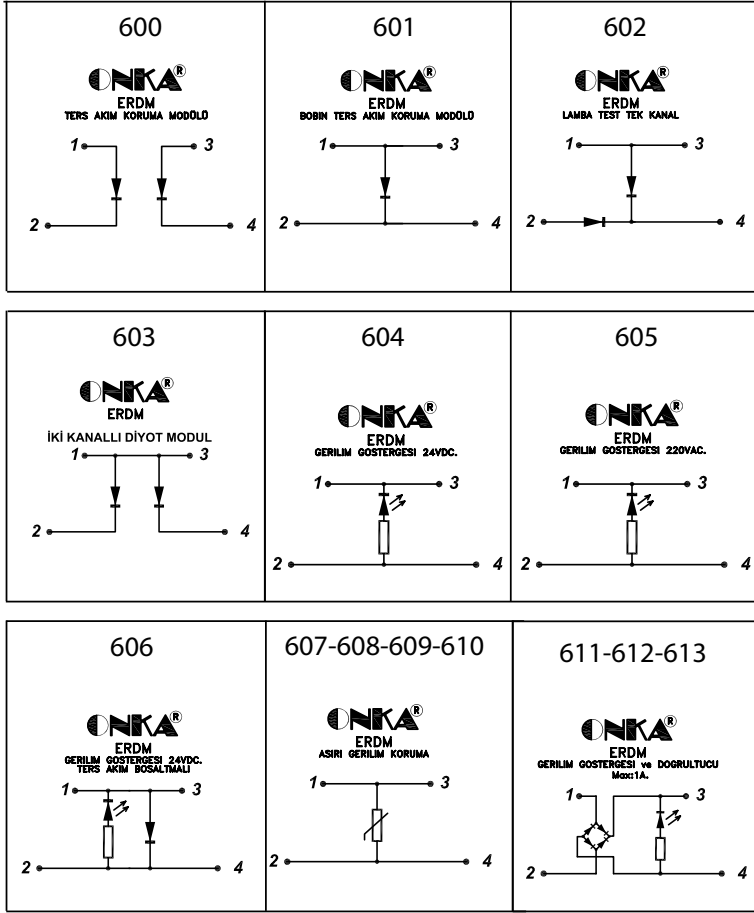

YENİ KOD	ESKİ KOD	AÇIKLAMA	ADET (t)
1050026	ONKA-600-ERDM	Ters Akım Koruma Modülü	(t)
1050027	ONKA-601-ERDM	Bobin Ters Akım Koruma Modülü	
1050028	ONKA-602-ERDM	Lamba Test Modülü Tekli	
1050029	ONKA-603-ERDM	İki Kanallı Diyot Modül	
1050030	ONKA-604-ERDM	Gerilim Göstergesi 24 VDC	
1050031	ONKA-605-ERDM	Gerilim Göstergesi 220 VAC	
1050032	ONKA-606-ERDM	Gerilim Göstergesi Ters Akım Boşaltmalı 24 VDC	
1050033	ONKA-607-ERDM	Aşırı Gerilim Koruma 30 V	
1050034	ONKA-608-ERDM	Aşırı Gerilim Koruma 75 V	
1050035	ONKA-609-ERDM	Aşırı Gerilim Koruma 130 V	
1050036	ONKA-610-ERDM	Aşırı Gerilim Koruma 275 V	
1050037	ONKA-611-ERDM	Gerilim Göstergesi - Doğrultma 24 VAC	
1050038	ONKA-612-ERDM	Gerilim Göstergesi - Doğrultma 110 VAC	
1050039	ONKA-613-ERDM	Gerilim Göstergesi - Doğrultma 220 VAC	

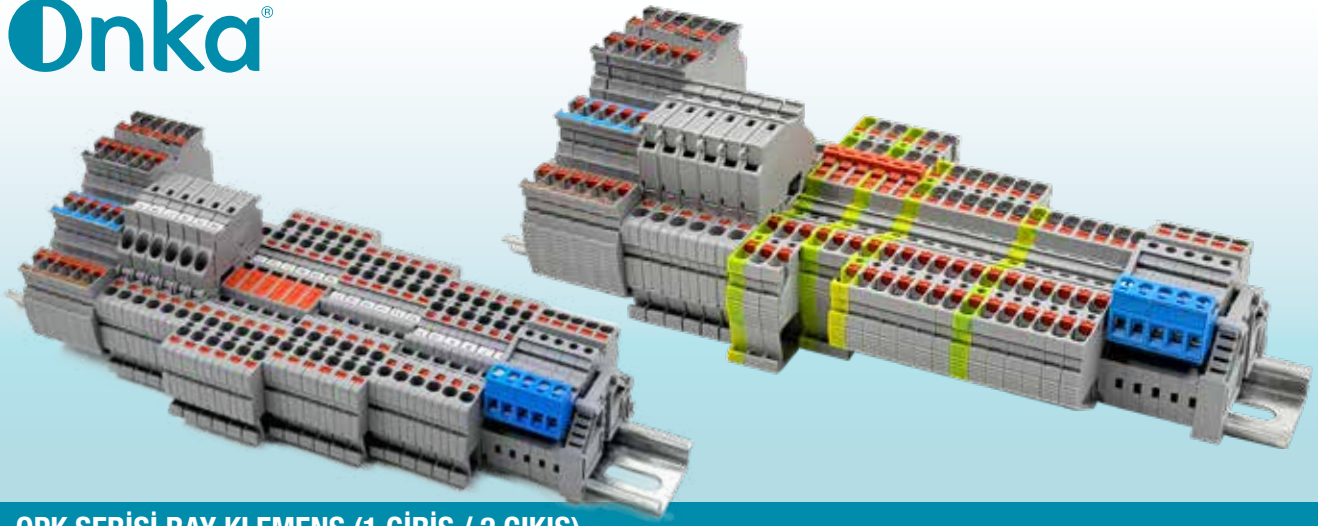

## OPK SERİSİ RAY KLEMENS (1 GİRİŞ / 2 ÇIKIŞ)

CİNSİ	GERİLİM / AKIM (V/A)	KUTU ADEDİ	RENK	ÜRÜN KODU	ESKİ KOD	ADET (₺)	ÜRÜN KODU (V0)	ESKİ KOD (V0)	ADET (V0) (₺)
<b>OPK</b> 2,5 / 4 mm <sup>2</sup>	750 V / 24 A	50	→	<b>1020284</b>	ONKA-1261	<b>96,05</b>			<b>99,50</b>
			→	<b>1020285</b>	ONKA-1262		<b>1020295</b>	ONKA-0662	
			→	<b>1020286</b>	ONKA-1263				
			→	<b>1020287</b>	ONKA-1264				
			→	<b>1020288</b>	ONKA-1265		<b>1020296</b>	ONKA-0665	
			→	<b>1020289</b>	ONKA-1266				
			→	<b>1020290</b>	ONKA-1267		<b>1020297</b>	ONKA-0667	
			→	<b>1020291</b>	ONKA-1268				
			→	<b>1020292</b>	ONKA-1269				



1 Giriş / 2 Çıkış

## OPK SERİSİ RAY KLEMENS (2 GİRİŞ / 2 ÇIKIŞ)

CİNSİ	GERİLİM / AKIM (V/A)	KUTU ADEDİ	RENK	ÜRÜN KODU	ESKİ KOD	ADET (₺)	ÜRÜN KODU (V0)	ESKİ KOD (V0)	ADET (V0) (₺)
<b>OPK</b> 2,5 / 4 mm <sup>2</sup>	750 V / 24 A	50	→	<b>1020274</b>	ONKA-1251	<b>96,80</b>			<b>101,00</b>
			→	<b>1020275</b>	ONKA-1252		<b>1020294</b>	ONKA-0652	
			→	<b>1020276</b>	ONKA-1253				
			→	<b>1020277</b>	ONKA-1254				
			→	<b>1020278</b>	ONKA-1255				
			→	<b>1020279</b>	ONKA-1256				
			→	<b>1020280</b>	ONKA-1257				
			→	<b>1020281</b>	ONKA-1258				
			→	<b>1020282</b>	ONKA-1259				



2 Giriş / 2 Çıkış

## OPK SERİSİ TEST KLEMENSİ (2 GİRİŞ / 2 ÇIKIŞ)

CİNSİ	GERİLİM / AKIM (V/A)	KUTU ADEDİ	RENK	ÜRÜN KODU	ESKİ KOD	ADET (₺)	ÜRÜN KODU (V0)	ESKİ KOD (V0)	ADET (V0) (₺)
<b>OPK</b> 2,5 / 4 mm <sup>2</sup>	750 V / 24 A	50	→	<b>1020264</b>	ONKA-1241	<b>140,15</b>			<b>144,70</b>
			→	<b>1020265</b>	ONKA-1242		<b>1020293</b>	ONKA-0642	
			→	<b>1020266</b>	ONKA-1243				
			→	<b>1020267</b>	ONKA-1244				
			→	<b>1020268</b>	ONKA-1245				
			→	<b>1020269</b>	ONKA-1246				
			→	<b>1020270</b>	ONKA-1247				
			→	<b>1020271</b>	ONKA-1248				
			→	<b>1020272</b>	ONKA-1249				



2 Giriş / 2 Çıkış  
Test Klemensi



## OPK SERİSİ RAY KLEMENS (1 GİRİŞ / 2 ÇIKIŞ)

CİNSİ	GERİLİM / AKIM (V/A)	KUTU ADEDİ	RENK	ÜRÜN KODU	ADET (₺)	ÜRÜN KODU (V0)	ADET (V0) (₺)
OPK Slim 2,5 mm <sup>2</sup>	750 V / 24 A	50	→	1020946	77,75	1020956	80,20
			→	1020947		1020957	
			→	1020948		1020958	
			→	1020949		1020959	
			→	1020950		1020960	
			→	1020951		1020961	
			→	1020952		1020962	
			→	1020953		1020963	
			→	1020954		1020964	
			→	1020955		1020965	

1 Giriş / 2 Çıkış

## OPK SERİSİ RAY KLEMENS (2 GİRİŞ / 2 ÇIKIŞ)

CİNSİ	GERİLİM / AKIM (V/A)	KUTU ADEDİ	RENK	ÜRÜN KODU	ADET (₺)	ÜRÜN KODU (V0)	ADET (V0) (₺)
OPK Slim 2,5 mm <sup>2</sup>	750 V / 24 A	50	→	1020966	87,75	1020976	90,45
			→	1020967		1020977	
			→	1020968		1020978	
			→	1020969		1020979	
			→	1020970		1020980	
			→	1020971		1020981	
			→	1020972		1020982	
			→	1020973		1020983	
			→	1020974		1020984	
			→	1020975		1020985	

2 Giriş / 2 Çıkış

## OPK SERİSİ TEST KLEMENSİ (1 GİRİŞ / 2 ÇIKIŞ)

CİNSİ	GERİLİM / AKIM (V/A)	KUTU ADEDİ	RENK	ÜRÜN KODU	ADET (₺)	ÜRÜN KODU (V0)	ADET (V0) (₺)
OPK Slim 2,5 mm <sup>2</sup>	750 V / 24 A	50	→	1020986	97,85	1020996	100,60
			→	1020987		1020997	
			→	1020988		1020998	
			→	1020989		1020999	
			→	1020990		1021000	
			→	1020991		1021001	
			→	1020992		1021002	
			→	1020993		1021003	
			→	1020994		1021004	
			→	1020995		1021005	

1 Giriş / 2 Çıkış Test Klemensi

## OPK SERİSİ TEST KLEMENSİ (2 GİRİŞ / 2 ÇIKIŞ)

CİNSİ	GERİLİM / AKIM (V/A)	KUTU ADEDİ	RENK	ÜRÜN KODU	ADET (₺)	ÜRÜN KODU (V0)	ADET (V0) (₺)
OPK Slim 2,5 mm <sup>2</sup>	750 V / 24 A	50	→	1021006	108,20	1021016	110,85
			→	1021007		1021017	
			→	1021008		1021018	
			→	1021009		1021019	
			→	1021010		1021020	
			→	1021011		1021021	
			→	1021012		1021022	
			→	1021013		1021023	
			→	1021014		1021024	
			→	1021015		1021025	

2 Giriş / 2 Çıkış Test Klemensi

## SOKETLİ RAY KLEMENS

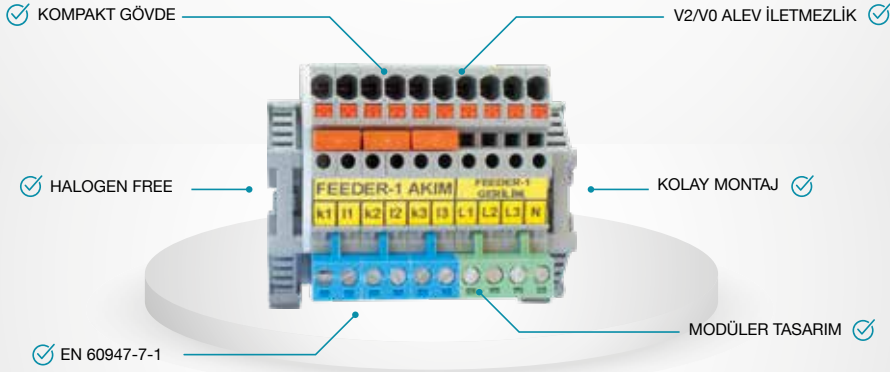

**Onka®**

Profesyonellerin Tercih

## PC-P Serisi soketli ray klemenslerimiz ile;

- Çok Pinli Plug-in Bağlantı Çözümleri
- Modüler Pano, Makina, Asansör vb. Uygulamalarınız için Hızlı Montaj / Demontaj
- Markalama Seçenekleri ile Doğru ve Kolay Bağlantı
- Modüler Yapısı ve Arttırılabilir Kutup Sayısı ile Esnek Çözümler

## YAY BAĞLANTILI SOKETLİ RAY KLEMENS

2,5 mm<sup>2</sup> / 5,08 mm

CİNSİ	GERİLİM / AKIM (V/A)	KUTU ADEDİ	RENK	ÜRÜN KODU	ESKİ KOD	ADET (₺)	ÜRÜN KODU (V0)	ESKİ KOD (V0)	ADET (V0) (₺)
PC-P 2,5 mm <sup>2</sup>	750 V / 16 A	50	→		ONKA-0381	48,00		ONKA-0321	49,00
			→	1020302	ONKA-0382		1020304	ONKA-0322	
			→		ONKA-0383			ONKA-0323	
			→		ONKA-0384			ONKA-0324	
			→		ONKA-0385			ONKA-0325	
			→		ONKA-0386			ONKA-0326	
			→		ONKA-0387			ONKA-0327	
			→		ONKA-0388			ONKA-0328	
			→		ONKA-0389			ONKA-0329	
			PCP-N Nihayet Plakası		10		⇨	1020301	

## PC-P SOKET SEÇENEKLERİ



PİN	ÜRETİM KODU	SİPARİŞ KODU (Renk ve Pin Sayısı Seçiniz!)						KUTU ADEDİ	ADET (\$)
		10.202	11.202	12.202	13.202	14.202	15.202		
2	SBDK 5,08-D/2	10.202	11.202	12.202	13.202	14.202	15.202	200	☎
3	SBDK 5,08-D/3	10.203	11.203	12.203	13.203	14.203	15.203	100	
4	SKBDK 5,08-D/4	10.204	11.204	12.204	13.204	14.204	15.204	100	
5	SBDK 5,08-D/5	10.205	11.205	12.205	13.205	14.205	15.205	100	
6	SBDK 5,08-D/6	10.206	11.206	12.206	13.206	14.206	15.206	100	
7	SBDK 5,08-D/7	10.207	11.207	12.207	13.207	14.207	15.207	100	
8	SBDK 5,08-D/8	10.208	11.208	12.208	13.208	14.208	15.208	100	
9	SBDK 5,08-D/9	10.209	11.209	12.209	13.209	14.209	15.209	100	
10	SBDK5,08-D/10	10.210	11.210	12.210	13.210	14.210	15.210	50	
11	SBDK 5,08-D/11	10.211	11.211	12.211	13.211	14.211	15.211	50	
12	SBDK 5,08-D/12	10.212	11.212	12.212	13.212	14.212	15.212	50	

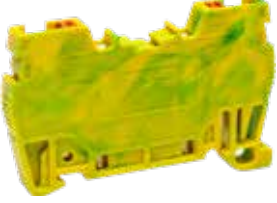
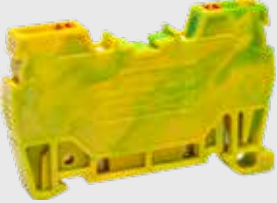
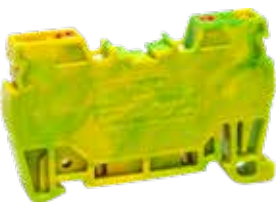

## OPK SERİSİ YAY BAĞLANTILI TOPRAKLAMA KLEMENSLERİ

CİNSİ	GERİLİM (V)	RENK	ÜRÜN KODU	ESKİ KOD	ADET (t)	KUTU ADEDİ
	750 V	→	1020834	-	134,55	100
	750 V	→	1020835	-	144,80	100
	750 V	→	1020299	ONKA-1199	147,70	100
	750 V	→	1020836	-	260,55	100
	750 V	→	1020300	ONKA-1200	341,00	100



**KÖPRÜLENEBİLİR!**

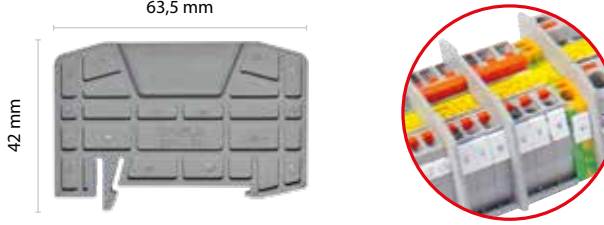

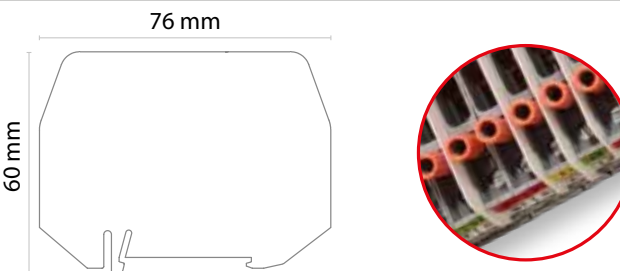





































## OPK SERİSİ AYIRMA PLAKASI

cinsi	KUTU ADEDİ	RENK	ÜRÜN KODU	ESKİ KOD	ADET
<b>Ayırma Plakası</b> 	25	→	1060053	ONKA-0592	22,05 ₺
		→	1060054	ONKA-0597	
<b>MRK-OPK Yüksek Tip Ayırma Plakası</b> 	25	→	1060526		26,25 ₺
		→	1060527		
		→	1060528		
		→	1060529		
		→	1060530		
		→	1060531		
		→	1060532		
		→	1060533		
		→	1060534		
<b>MRK-OPK Yüksek Tip Ayırma Plakası Slim</b> 	25	→	ONKA-0999		0,21 €

## OPK RAY KLEMENS İŞARETLERİ VE ETİKET YUVASI

cinsi	ÜRÜN KODU	ESKİ KOD	ADET (₺)	KUTU ADEDİ
 <b>Ray Klemens 11-12 mm Etiket Yuvası</b>	1060076	ONKA-1289	1,50 ₺	1000
 <b>11 mm X 2 X 20 mt Duple Şerit Etiket (Sarı/Beyaz)</b>	ONKA-8943-S11SB		29 €	1

## MRK VE OPK SERİSİ DURDURUCULAR

CİNSİ	KUTU ADEDİ	RENK	ÜRÜN KODU	ESKİ KOD	ADET (t)			
Küçük Durdurucu 	100		1060013	ONKA-1221	27,40			
			1060014	ONKA-1222				
			1060015	ONKA-1223				
			1060016	ONKA-1224				
			1060017	ONKA-1225				
			1060018	ONKA-1226				
			1060019	ONKA-1227				
			1060020	ONKA-1228				
			1060021	ONKA-1229				
		Büyük Durdurucu  <b>*ONKA-8920-736SE/SB</b>	100			1060004	ONKA-1211	51,90
	1060005			ONKA-1212				
	1060006			ONKA-1213				
	1060007			ONKA-1214				
	1060008			ONKA-1215				
	1060009			ONKA-1216				
	1060010			ONKA-1217				
	1060011			ONKA-1218				
	1060012			ONKA-1219				
Grup Etiketli Durdurucu  <b>*ONKA-8920-736SE/SB</b>	100				1060023	ONKA-1231	52,40	
					1060024	ONKA-1232		
					1060025	ONKA-1233		
			1060026	ONKA-1234				
			1060027	ONKA-1235				
			1060028	ONKA-1236				
			1060029	ONKA-1237				
			1060030	ONKA-1238				
			1060031	ONKA-1239				
		Ray Klemens Grup Etiketli  <b>*ONKA-8920-736SE/SB &amp; ONKA-8943-SBG</b>	100					26,50
					1060500			
	1060501							
	1060502							
	1060503							
	1060504							
	1060505							
	1060506							
	1060507							

## MRK VE OPK SERİSİ VİDASIZ DURDURUCU VE ÜSTTEN GEÇMELİ GRUP ETİKETİ

CİNSİ	KUTU ADEDİ	RENK	ÜRÜN KODU	ESKİ KOD	ADET (t)
Vidasız Durdurucu  <b>*ONKA-8920-736SE/SB &amp; ONKA-8943-SBG</b>	100		1060001	ONKA-1201	39,40
			1060002	ONKA-1202	
			1060003	ONKA-1203	
Üstten Geçmeli Grup Etiketi 	100		1060093	ONKA-1482	8,80

## OPK SERİSİ RAY KLEMENS ÜST KÖPRÜ (Geçmeli)



Köprü üzerindeki kesme kanalları sayesinde pin aralığının merkezinden kesim imkanı sağlar.

\* Bu özellik 10 Pinli ve 20 Pinli üst köprüler için geçerlidir.



Köprü üzerindeki form sayesinde tornavida ile demonte edilebilir.



İzole gövdenin tek parça olması iletken baraya yüksek dayanıklılık sağlar.



Tutucu form ile güvenli bağlantı sağlanır.

Formlu Pin yapıyla baraya dört noktadan sürekli ve güvenli temas sağlanır.



SADECE OPK SERİSİ İLE KULLANILIR.



GİNSİ	RENK	ÜRÜN KODU	ESKİ KOD	ADET (t)	KUTU ADEDİ
1.5 x 2	→	1060101	ONKA-1920	50,65	100
1.5 x 3	→	1060102	ONKA-1921	61,10	100
1.5 x 4	→	1060103	ONKA-1922	73,30	100
1.5 x 10	→	1060104	ONKA-1923	143,55	30
1.5 x 20	→	1060105	ONKA-1924	248,60	20
2.5 x 2	→	1060106	ONKA-1925	52,90	100
2.5 x 3	→	1060107	ONKA-1926	67,75	100
2.5 x 4	→	1060108	ONKA-1927	75,40	75
2.5 x 10	→	1060109	ONKA-1928	156,50	30
2.5 x 20	→	1060110	ONKA-1929	281,80	20
4 x 2	→	1060111	ONKA-1930	56,80	100
4 x 3	→	1060112	ONKA-1931	75,40	50
4 x 4	→	1060113	ONKA-1932	82,75	50
4 x 10	→	1060114	ONKA-1933	175,00	30
4 x 20	→	1060115	ONKA-1934	305,00	20
6 x 2	→	1060126	ONKA-1945	61,10	100
6 x 3	→	1060127	ONKA-1946	72,35	50
6 x 4	→	1060128	ONKA-1947	88,90	50
6 x 10	→	1060129	ONKA-1948	179,15	15
6 x 20	→	1060130	ONKA-1949	327,60	10
10 x 2	→	1060131	ONKA-1950	62,55	100
10 x 3	→	1060132	ONKA-1951	78,80	50
10 x 4	→	1060133	ONKA-1952	96,30	25
10 x 10	→	1060134	ONKA-1953	201,00	15
10 x 20	→	1060135	ONKA-1954	373,20	10
16 x 2	→	1060136	ONKA-1955	91,45	10
16 x 3	→	1060137	ONKA-1956	132,80	10
16 x 4	→	1060138	ONKA-1957	182,60	10
16 x 10	→	1060139	ONKA-1958	400,85	10
35 x 2	→	1060140	ONKA-1959	113,15	10
35 x 3	→	1060141	ONKA-1960	164,15	10
35 x 4	→	1060142	ONKA-1961	224,50	10
35 x 10	→	1060143	ONKA-1962	505,30	10



4,9 mm  
Şerit Etiket

5x5mm  
Dekafix

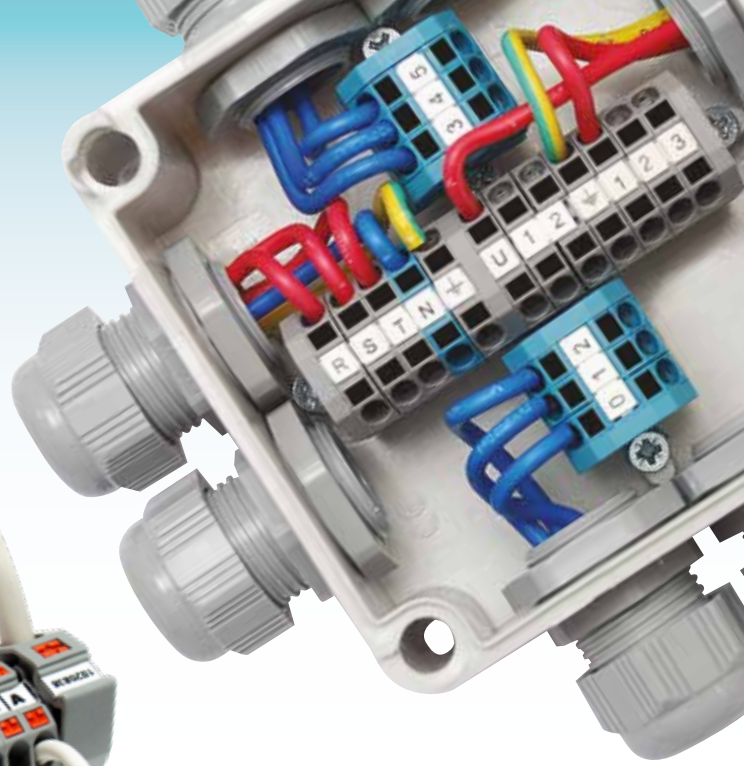
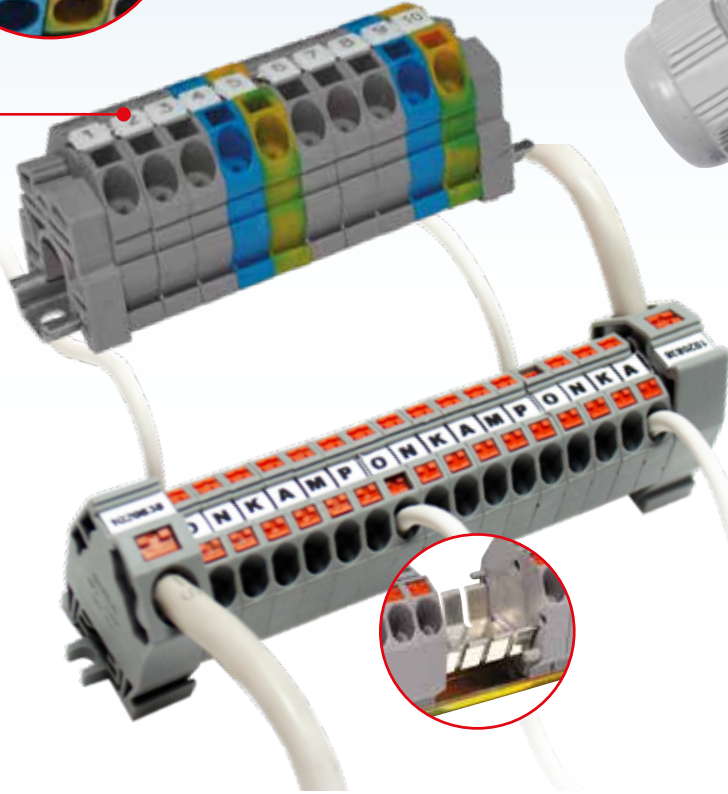

**PUSH IN**

## Yay Bağlantılı Mini Ray Klemensler

## MPK & MP SERİSİ

MPK raya montaj mini yay bağlantılı klemensler birleştirilmiş yapısıyla kullanıcıya bir çok fayda sağlamaktadır. OPK klemens grubunun mini versiyonu olarak dizayn edilmiştir. Mini yay bağlantılı klemensler, OPK serisi ile aynı özellikleri taşımaktadır. Yüksüklü ve yüksüksüz kabloların sadece ileri itilmesiyle başka herhangi bir alete ihtiyaç duyulmadan kolayca montaj imkanı sağlar.

Küçük kompakt yapısı sayesinde pano ve bağlantı kutuları içinde kullanıcıya alan kazandırarak ergonomik tasarımlar yaratır.

MPK Klemens serisi, 15 x 5,5 mm raya ve farklı sonlandırma plaka alternatifleriyle de düz zemin üzerine monte edilebilir.

Mini Yay bağlantılı Klemenslerin kontak kısmı kalay kaplı bakırdan oluşmaktadır. Paslanmaz çelik, krom ve nikel alaşımından üretilmiş yay, kablo üzerine baskı uygular. Su, Asit ve yüksek ısı içeren atmosfer koşullarına karşı yüksek dayanım göstererek okside olmaz. Mini yay bağlantılı klemenslerin yapısı, buatların içinde kullanıma olanak sağlar. Ürünün dışı, poliamid gövdesi sayesinde, patlayıcıların ve gazların bulunduğu alanlarda da güvenle kullanımına olanak sağlar. MPK Klemens serisi bir çok renk alternatifine sahiptir.

Bu ürünün en dikkat çekici özelliklerinden biri de, markalama zenginliği ve 2'li, 3lü, 4'lü ve talebe bağlı daha fazla modüllerde dizayn edilebilmesidir. Bütün terminallerin birbirine eş potansiyel köprülenebilir özelliği sayesinde, dağıtım ve toplama barası şeklinde kullanım imkanı da sağlarken düşük bağlantı empedanslı ideal buat uygulamaları yapılabilir. Bu ürün nötr dağıtım ve topraklama işlerinde yoğun olarak kullanılır. MPK klemens serisinin markalamasında piyasada yaygın olarak tercih edilen 5x5 mm dekafixler ve 4,9 mm şerit etiketler kullanılmaktadır. Ürünün yay bağlantılı olması vibrasyonlu ortamlarda da güvenle kullanılmasına olanak sağlamaktadır.

### MONTAJA UYGUN RAY ÇEŞİTLERİ

ÜRÜN KODU	ESKİ KOD
1100109	ONKA-4246
1100110	ONKA-4247
1100111	ONKA-4248
1100114	ONKA-4251
1100115	ONKA-4252
1100116	ONKA-4253

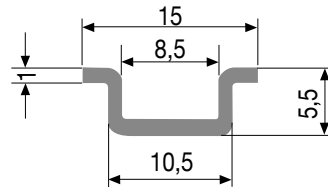

## MPK SERİSİ MİNİ YAY BAĞLANTILI KLEMENSLER (PUSH-IN HER İKİ TARAFI KAPALI SİSTEM)

cinsi	GERİLİM / AKIM (V/A)	KUTU ADEDİ	RENK	ÜRÜN KODU	ESKİ KOD	ADET (t)
MPK 2,5 mm <sup>2</sup>	750 V / 24 A	100		1020305	ONKA-1421	31,95
				1020306	ONKA-1422	
				1020307	ONKA-1423	
				1020308	ONKA-1424	
				1020309	ONKA-1425	
				1020310	ONKA-1426	
				1020311	ONKA-1427	
				1020312	ONKA-1428	
				1020313	ONKA-1429	







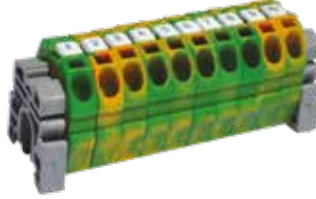



## MPK SERİSİ MİNİ YAY BAĞLANTILI TOPRAKLI KLEMENSLER (PUSH-IN HER İKİ TARAFI KAPALI SİSTEM)

cinsi	GERİLİM / AKIM (V/A)	KUTU ADEDİ	RENK	ÜRÜN KODU	ESKİ KOD	ADET (t)
MPK 2,5 mm <sup>2</sup>	750 V / 24 A	100		1020335	ONKA-1470	37,20





## MPK SERİSİ DURDURUCU (MİNİ DURDURUCU)

cinsi	KUTU ADEDİ	RENK	ÜRÜN KODU	ESKİ KOD	ADET (t)
MPK Serisi Durdurucu	100		1060083	ONKA-1471	28,10
			1060084	ONKA-1472	
			1060085	ONKA-1473	
			1060086	ONKA-1474	
			1060087	ONKA-1475	
			1060088	ONKA-1476	
			1060089	ONKA-1477	
			1060090	ONKA-1478	
			1060091	ONKA-1479	



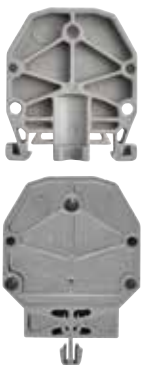









## MP SERİSİ DURDURUCU VE SONLANDIRICI













cinsi	KUTU ADEDİ	RENK	ÜRÜN KODU	ESKİ KOD	ADET (t)
Durdurucu ve Sonlandırıcı Raya Takılabilir ve Zemine Vidalanabilir.	100		1060034	ONKA-1442	7,30
Durdurucu ve Sonlandırıcı Zemine Geçmeli.	100		1060043	ONKA-1452	7,30



## MP SERİSİ MİNİ YAY BAĞLANTILI KLEMENSLER (PUSH-IN SİSTEM)

CİNSİ	GERİLİM / AKIM (V/A)	KUTU ADEDİ	RENK	ÜRÜN KODU	ESKİ KOD	ADET (t)
	750 V / 24 A	100		1020326	ONKA-1461	33,40
				1020327	ONKA-1462	
				1020328	ONKA-1463	
				1020329	ONKA-1464	
				1020330	ONKA-1465	
				1020331	ONKA-1466	
				1020332	ONKA-1467	
				1020333	ONKA-1468	
	1020334	ONKA-1469				



## MP SERİSİ MİNİ YAY BAĞLANTILI KLEMENSLER (İÇTEN KÖPRÜLÜ) X KLEMENS ADEDİ

CİNSİ	GERİLİM / AKIM (V/A)	KUTU ADEDİ	RENK	ÜRÜN KODU	ESKİ KOD	ADET (t)
 <p><b>! *Set içindeki KÖPRÜLENEN KLEMENS adedi ile fiyatlandırılır.</b></p>	750 V / 24 A	Proje		1020314	ONKA-1431	33,40
				1020315	ONKA-1432	
				1020316	ONKA-1433	
				1020317	ONKA-1434	
				1020318	ONKA-1435	
				1020319	ONKA-1436	
				1020320	ONKA-1437	
				1020321	ONKA-1438	
				1020322	ONKA-1439	

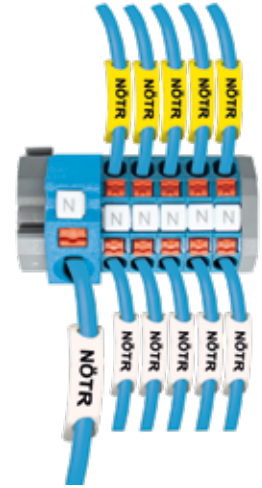
## MP SERİSİ MİNİ YAY BAĞLANTILI SETLER İÇİN 6 mm² BAŞTAN BESLEME MODÜLÜ (DAĞITIM BLOĞU)



Saha elektrifikasyonu ve pano içi dağıtım/toplama uygulamaları için 0-2,5 mm² push-in bağlantılı sınırsız esnek kombinasyon çözümleri.

CİNSİ	GERİLİM / AKIM (V/A)	KUTU ADEDİ	RENK	ÜRÜN KODU	ADET (t)
 <p><b>! *2,5 - 10 mm² aralıktaki besleme kabloları için eklenir.</b></p>	750 V / 41 A	Proje		1020837	58,10
				1020838	
				1020839	
				1020840	
				1020841	
				1020842	
				1020843	
				1020844	
	1020845				



Kod: **MP-BUS6**



6 x 0,5 - 2,5 IN/OUT

Kod: **MP-BUS8**



8 x 0,5 - 2,5 IN/OUT

Kod: **MP-BUS10**



10 x 0,5 - 2,5 IN/OUT

Kod: **MP-BUS12**



12 x 0,5 - 2,5 IN/OUT

Kod: **MP-BUS18**



18 x 0,5 - 2,5 IN/OUT

Kod: **MP-BUS24**



24 x 0,5 - 2,5 IN/OUT

Sipariş için satış temsilcisi ve bayilerimizle irtibata geçiniz, renk tercihinizi siparişte belirtiniz.



## MP-BUS SERİSİ TEK GİRİŞ BAŞTAN BESLEMELİ DAĞITICI VE TOPLAYICI



Kod: **MP-BUS6T**



1 x 2,5 - 10 mm<sup>2</sup> IN / 6 x 0,5 - 2,5 OUT

Kod: **MP-BUS8T**



1 x 2,5 - 10 mm<sup>2</sup> IN / 8 x 0,5 - 2,5 OUT

Kod: **MP-BUS10T**



1 x 2,5 - 10 mm<sup>2</sup> IN / 10 x 0,5 - 2,5 OUT

Kod: **MP-BUS12T**



1 x 2,5 - 10 mm<sup>2</sup> IN / 12 x 0,5 - 2,5 OUT

Kod: **MP-BUS18T**



1 x 2,5 - 10 mm<sup>2</sup> IN / 18 x 0,5 - 2,5 OUT

Kod: **MP-BUS24T**



1 x 2,5 - 10 mm<sup>2</sup> IN / 24 x 0,5 - 2,5 OUT

Sipariş için satış temsilcisi ve bayilerimizle irtibata geçiniz, renk tercihinizi siparişte belirtiniz.





Kod: **MP-BUS6C**



2 x 2,5 - 10 mm<sup>2</sup> IN / 6 x 0,5 - 2,5 OUT

Kod: **MP-BUS8C**



2 x 2,5 - 10 mm<sup>2</sup> IN / 8 x 0,5 - 2,5 OUT

Kod: **MP-BUS10C**



2 x 2,5 - 10 mm<sup>2</sup> IN / 10 x 0,5 - 2,5 OUT

Kod: **MP-BUS12C**



2 x 2,5 - 10 mm<sup>2</sup> IN / 12 x 0,5 - 2,5 OUT

Kod: **MP-BUS18C**



2 x 2,5 - 10 mm<sup>2</sup> IN / 18 x 0,5 - 2,5 OUT

Kod: **MP-BUS24C**



2 x 2,5 - 10 mm<sup>2</sup> IN / 24 x 0,5 - 2,5 OUT

Sipariş için satış temsilcisi ve bayilerimizle irtibata geçiniz, renk tercihinizi siparişte belirtiniz.





İZMİR ŞEHİR HASTANESİ  
ADANA ŞEHİR HASTANESİ  
YATAĞAN DEVLET HASTANESİ  
BÜNYAN DEVLET HASTANESİ  
ÇAN DEVLET HASTANESİ  
GÖKYOL DEVLET HASTANESİ  
BURSA ŞEHİR HASTANESİ  
KONYA ŞEHİR HASTANESİ

EGE ÜNİVERSİTESİ  
RTE ÜNİVERSİTESİ  
KOCAELİ ÜNİVERSİTESİ  
DİCLE ÜNİVERSİTESİ  
AKDENİZ ÜNİVERSİTESİ  
BALIKESİR ÜNİVERSİTESİ  
BURDUR ÜNİVERSİTESİ

Gelişen teknoloji ile birlikte doğan özel ihtiyaçların karşılanmasına yönelik; kompakt, estetik, işletme ömrü boyunca tesisi yöneten teknik personelin binlerce düğüm noktası arasında sağlıklı ve kontrollü işlem yapabileceği, her açıdan sürdürülebilir kalite sağlayacak optimum bağlantı tasarımları sunuyoruz.

Standardizasyon gerektiren yapı ve sistemler için proje grubumuzla geliştirdiğimiz bağlantı çözümlerimiz ve hazır set tasarımlarımızla teknik ve ekonomik avantajlar sağlıyoruz.

**Onka®**

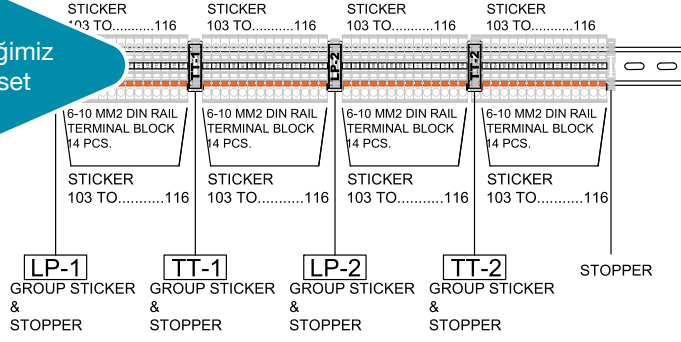

TİP-1 SET (GRI)

53mm

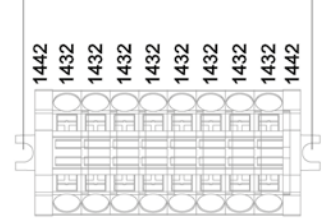

## PROJE ve UYGULAMALARINIZA ÖZEL SET TASARIM ve ÇÖZÜMLERİ

- ✓ Yatırım ve Uygulama Süreçlerinde Düşük Maliyet
- ✓ Standartizasyon Sayesinde Kurulum ve İşletme Hatalarının Minimize Edilmesi
- ✓ Geniş Renk Seçeneği ve Markalama Yapısıyla Daha Doğru , Daha Hızlı Uygulama
- ✓ Daha Düşük Bağlantı Empedansıyla Daha Az Kayıp, Daha Yüksek İş

## KULLANIM ALANLARI

- ✓ YURTLAR
- ✓ OKULLAR
- ✓ HASTANELER
- ✓ ARITMA TESİSLERİ
- ✓ SAVUNMA SANAYİİ
- ✓ BİLGİ İŞLEM MERKEZLERİ
- ✓ TRAFİK YÖNETİM SİSTEMLERİ
- ✓ ENERJİ ÜRETİM/İLETİM/DAĞITIM TESİSLERİ
- ✓ AKILLI BİNA OTOMASYONU VE HVAC SİSTEMLERİ
- ✓ MAKİNE, ASANSÖR, VİNÇ, EKİPMAN SERİ ÜRÜNLERİ

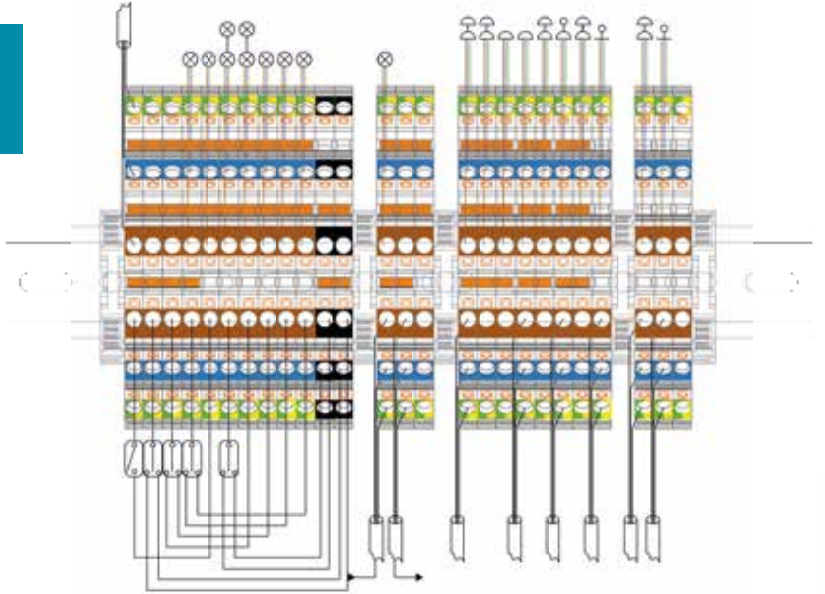

Bilgi ve teknik destek için satış/pazarlama birimlerimizle irtibata geçiniz.

[www.Onka.com.tr](http://www.Onka.com.tr)



- Kolay kurulum
- Windows sürümleriyle uyumlu
- Online versiyon ile kurulumuz çalışma ve web üzerinden tasarım + baskı
- Gelişmiş tasarım araçları ile; yazı - çizim - resim ve seriler oluşturma
- Oluşturduğunuz proje ve şablonlarınızı kaydetme veya taşıma
- Farklı dosya formatlarını destekleme (.xls, .jpeg, .png)
- Yapay zeka desteği ile yalnızca markalama değil, bir çok üretim sürecinin optimizasyonu.



## ONKAMARK İLE;

- Hata Tespiti: Üretim hatlarında montaj ve etiketleme hatalarını tespit ederek otomatik kalite kontrol sağlar.
- Otomatik Sınıflandırma: Ürünlerin otomatik olarak sınıflandırılması ve doğru etiketlerin atanması için yapay zeka algoritmaları kullanılır. Bu, özellikle büyük ürün yelpazeleri için zaman tasarrufu sağlar.
- Takip ve İzleme: Etiketleme takip edilerek tedarik zinciri boyunca ürünlerin izlenmesi ve stok yönetimini kolaylaştırabilir. Verimlilik artar ve lojistik süreçlerini optimize edilir.
- Kişiselleştirme: Kullanıcı taleplerine göre kişiselleştirilmiş etiketleme için şablonlar ve projeler oluşturulabilir. Örneğin, müşteri verileri analiz edilerek hedef kitleye özel hazır etiketler, projeler ve şablonlar oluşturulabilir.
- Veri Analizi: Etiketleme verileri analiz edilerek üretim süreçlerinde iyileştirmeler yapılmasına yardımcı olur.



Detaylı bilgi ve demo sürümü için; [www.onkamark.com.tr](http://www.onkamark.com.tr) ve satış temsilcilerimizle iletişime geçiniz.

**KURULUM VE TEKNİK DESTEK: [onkamark@onka.com.tr](mailto:onkamark@onka.com.tr)**



### ONKAMARK AI Teknolojisi ;

- Makine öğrenimi ve derin öğrenme temelli görsel tanıma teknolojileriyle entegre çalışarak, ürünleri tanıyabilir ve doğru etiketlerin uygulanmasını sağlar. Bu özellikle farklı türde çok sayıda ürünün hızlı ve hatasız şekilde etiketlenmesi gereken durumlarda yararlıdır.
- Ürün özelliklerini (boyut, renk, tür vb.) analiz ederek otomatik olarak uygun etiketleri belirleyebilir ve uygulayabilir. Bu, manuel etiketleme süreçlerine kıyasla hem zaman hem de maliyet açısından verimliliği artırır.
- Etiketlenmiş ürünleri tarayarak etiketlerin doğru ve okunabilir olup olmadığını kontrol edebilir. Eksik veya hatalı etiketlemeleri tespit edip düzeltmek için kullanılabilir.
- RFID ve Optik Tanımlama gibi teknolojilerle entegre kullanıldığında, etiketlenmiş ürünleri gerçek zamanlı olarak takip edebilir. Bu, tedarik zinciri yönetiminde ve stok takibinde büyük kolaylık sağlar.
- Etiketleme verilerini analiz ederek süreçlerdeki eğilimleri ve düzenlilikleri belirleyebilir. Bu analizler, süreçlerin iyileştirilmesi ve optimizasyonu için değerli bilgiler sunar.
- Değişen üretim şartlarına ve yeni elektrik bileşenlerine hızlıca adapte olabilir. Bu, sürekli güncellenen teknolojilerle çalışırken büyük avantaj sağlar.
- Bu teknikler, yalnızca etiketleme süreçlerini otomatize etmek, hızlandırmak ve hataları azaltmakla kalmaz. ONKAMARK AI'nın sürekli öğrenme kabiliyeti, süreçlerin zamanla daha da verimli hale gelmesini sağlar.
- ONKAMARK AI, elektrifikasyon ve otomasyon uygulamalarındaki etiketleme süreçlerinizi birden çok şekilde kolaylaştırabilir.





ONKA-8912-AX



4,9mm X 5 X 20 mt  
Şerit Etiket



Isı büzüşmeli makarona  
ONKA-8944-70  
ribon ile baskı

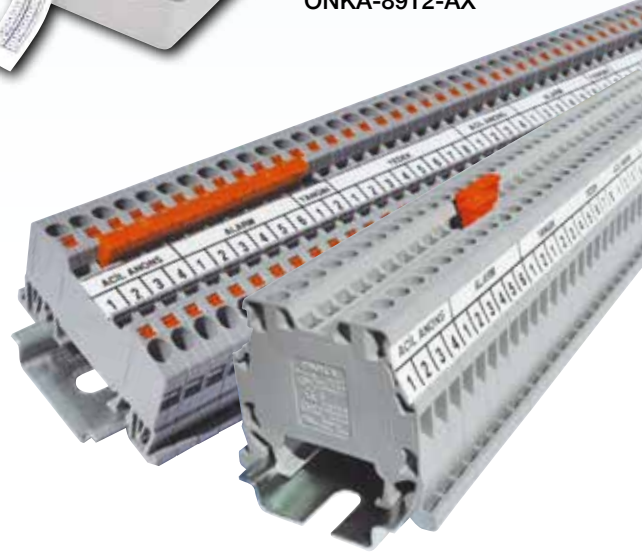

## 2x20 Metre

Toplam Şerit Uzunluğu **40 metre**

40 metrelik şerit ile yaklaşık;  
7.500 adet 1,5 mm<sup>2</sup> lik,  
6.500 adet 2,5 mm<sup>2</sup> lik,  
5.500 adet 4 mm<sup>2</sup> lik,  
4.500 adet 6 mm<sup>2</sup> lik,  
4.000 adet 10 mm<sup>2</sup> lik  
klemens etiketlenebilmektedir.



Rulo Açma Aparatı



ONKA-8944-55



ONKA-8944-110



ONKA-8943-S11

## MARKALAMA SİSTEMLERİ

### KLEMENSLER İÇİN ŞERİT MARKALAMA SİSTEMİ

ÜRÜN KODU	AÇIKLAMA	ADET (€)	KUTU ADEDİ
ONKA-8912-AX	ARGOX CP2140 Termal Yazıcı	1	1
ONKA-8912-GS	GS2406T Termal Yazıcı	1	1
ONKA-8912-RA1	Rulo Açma Aparatı	28,00 €	1
ONKA-8944-55	55 mm X 300 mt Siyah Ribon (Şerit Etiketler için)	52,50 €	300 MT
ONKA-8944-70	70 mm X 300 mt Siyah Ribon - PR (Makaron ve Şeffaf Tüp Etiketleri)	65,00 €	300 MT
ONKA-8944-110	110 mm x 300 mt Siyah Ribon	130,00 €	300 MT
ONKA-8943-S11SB	11 mm X 2 X 20 mt Double Şerit Etiket (Sarı/Beyaz)	29,00 €	40 MT
ONKA-8943-SBG	7,75 mm X 3 X 20 mt Şerit Etiket (Beyaz/Sarı)	29,00 €	40 MT
ONKA-8843-S4.9	4,9 mm X 5 X 20 mt Şerit Etiket	29,00 €	100 MT

## KOMPONENT ETİKETLERİ



ÜRÜN KODU	RENK	AÇIKLAMA	UYGUN RİBON	RULO (€)	SÜTUN SAYISI	RULO ADEDİ
ONKA-8920-915SE	→	9x15 mm Sarı Komponent Etiketi (EKO)	110	60,00 €	5	5000 ADET
ONKA-8920-915BE	→	9x15 mm Beyaz Komponent Etiketi (EKO)	110	60,00 €	5	5000 ADET
ONKA-8920-915SG	→	9x15 mm Gümüş Gri Komponent Etiketi	110	70,00 €	5	2500 ADET
ONKA-8920-716SE	→	16x7 mm Sarı Komponent Etiketi (EKO)	110	60,00 €	5	5000 ADET
ONKA-8920-716BE	→	16x7 mm Beyaz Komponent Etiketi (EKO)	110	60,00 €	5	5000 ADET
ONKA-8920-930S	→	9x30 mm Sarı Komponent Etiketi	55-110	110,00 €	3	1500 ADET
ONKA-8920-912SE	→	9x12 mm Sarı Komponent Etiketi (EKO)	110	42,00 €	5	2500 ADET
ONKA-8920-736SE	→	7x36 mm Sarı Komponent Etiketi (EKO)	55-110	42,00 €	1	1000 ADET
ONKA-8920-736BE	→	7x36 mm Beyaz Komponent Etiketi (EKO)	55-110	42,00 €	1	1000 ADET

## GENEL AMAÇLI ŞERİT ETİKETLER



ÜRÜN KODU	RENK	AÇIKLAMA	UYGUN RİBON	RULO (€)	SÜTUN SAYISI	RULO ADEDİ
ONKA-8920-2015S	→	20 mm x 15 mt Sarı Genel Amaçlı Şerit Etiket	55-110	21,00 €	1	15 MT
ONKA-8920-1550B	→	15 mm x 50 mt Beyaz Genel Amaçlı Şerit Etiket	55-110	35,00 €	1	50 MT
ONKA-8920-1550S	→	15 mm x 50 mt Sarı Genel Amaçlı Şerit Etiket	55-110	35,00 €	1	50 MT
ONKA-8920-1550K	→	15 mm x 50 mt Kırmızı Genel Amaçlı Şerit Etiket	55-110	35,00 €	1	50 MT
ONKA-8920-1550G	→	15 mm x 50 mt Gümüş Gri Genel Amaçlı Şerit Etiket	55-110	35,00 €	1	50 MT
ONKA-8920-2050B	→	20 mm x 50 mt Beyaz Genel Amaçlı Şerit Etiket	55-110	47,00 €	1	50 MT
ONKA-8920-2050S	→	20 mm x 50 mt Sarı Genel Amaçlı Şerit Etiket	55-110	47,00 €	1	50 MT
ONKA-8920-2050K	→	20 mm x 50 mt Kırmızı Genel Amaçlı Şerit Etiket	55-110	47,00 €	1	50 MT
ONKA-8920-2050G	→	20 mm x 50 mt Gümüş Gri Genel Amaçlı Şerit Etiket	55-110	47,00 €	1	50 MT
ONKA-8920-3050B	→	30 mm x 50 mt Beyaz Genel Amaçlı Şerit Etiket	55-110	70,00 €	1	50 MT
ONKA-8920-3050S	→	30 mm x 50 mt Sarı Genel Amaçlı Şerit Etiket	55-110	70,00 €	1	50 MT
ONKA-8920-3050K	→	30 mm x 50 mt Kırmızı Genel Amaçlı Şerit Etiket	55-110	70,00 €	1	50 MT
ONKA-8920-3050G	→	30 mm x 50 mt Gümüş Gri Genel Amaçlı Şerit Etiket	55-110	70,00 €	1	50 MT
ONKA-8920-5050B	→	50 mm x 50 mt Beyaz Genel Amaçlı Şerit Etiket	55-110	117,00 €	1	50 MT
ONKA-8920-5050S	→	50 mm x 50 mt Sarı Genel Amaçlı Şerit Etiket	55-110	117,00 €	1	50 MT
ONKA-8920-5050K	→	50 mm x 50 mt Kırmızı Genel Amaçlı Şerit Etiket	55-110	117,00 €	1	50 MT
ONKA-8920-5050G	→	50 mm x 50 mt Gümüş Gri Genel Amaçlı Şerit Etiket	55-110	117,00 €	1	50 MT



## ORTA KALIN PANO ETİKETLERİ



ÜRÜN KODU	RENK	AÇIKLAMA	UYGUN RİBON	RULO (€)	SÜTUN SAYISI	RULO ADEDİ
ONKA-8923-1527OB	☐→	15X27 mm Orta Kalın Pano Etiketi Beyaz	55-110	130,00 €	1	500 ADET
ONKA-8923-1527OK	→	15X27 mm Orta Kalın Pano Etiketi Kırmızı	55-110	130,00 €	1	750 ADET
ONKA-8923-1527OS	→	15X27 mm Orta Kalın Pano Etiketi Sarı	55-110	130,00 €	1	500 ADET
ONKA-8923-1527OG	→	15X27 mm Orta Kalın Pano Etiketi Gümüş Gri	110	230,00 €	3	1500 ADET
ONKA-8923-1827OB	☐→	18X27 mm Orta Kalın Pano Etiketi Beyaz	55-110	160,00 €	1	500 ADET
ONKA-8923-1827OK	→	18X27 mm Orta Kalın Pano Etiketi Kırmızı	55-110	160,00 €	1	500 ADET
ONKA-8923-1827OS	→	18X27 mm Orta Kalın Pano Etiketi Sarı	55-110	160,00 €	1	500 ADET
ONKA-8923-1827OG	→	18X27 mm Orta Kalın Pano Etiketi Gümüş Gri	55-110	160,00 €	1	500 ADET
ONKA-8923-1545OB	☐→	15X45 mm Orta Kalın Pano Etiketi Beyaz	55-110	160,00 €	1	500 ADET
ONKA-8923-1545OK	→	15X45 mm Orta Kalın Pano Etiketi Kırmızı	55-110	160,00 €	1	500 ADET
ONKA-8923-1545OS	→	15X45 mm Orta Kalın Pano Etiketi Sarı	55-110	160,00 €	1	500 ADET
ONKA-8923-1545OG	→	15X45 mm Orta Kalın Pano Etiketi Gümüş Gri	55-110	265,00 €	1	1000 ADET
ONKA-8923-3065OB	☐→	30X65 mm Orta Kalın Pano Etiketi Beyaz	110	210,00 €	1	250 ADET
ONKA-8923-3065OK	→	30X65 mm Orta Kalın Pano Etiketi Kırmızı	110	210,00 €	1	250 ADET
ONKA-8923-3065OS	→	30X65 mm Orta Kalın Pano Etiketi Sarı	110	210,00 €	1	250 ADET
ONKA-8923-3065OG	→	30X65 mm Orta Kalın Pano Etiketi Gümüş Gri	110	333,00 €	1	500 ADET
ONKA-8923-50100OB	☐→	50X100 mm Orta Kalın Pano Etiketi Beyaz	110	385,00 €	1	250 ADET
ONKA-8923-50100OK	→	50X100 mm Orta Kalın Pano Etiketi Kırmızı	110	385,00 €	1	250 ADET
ONKA-8923-50100OS	→	50X100 mm Orta Kalın Pano Etiketi Sarı	110	385,00 €	1	250 ADET
ONKA-8923-50100OG	→	50X100 mm Orta Kalın Pano Etiketi Gümüş Gri	110	385,00 €	1	250 ADET
ONKA-8923-3050OB	☐→	30X50 mm Orta Kalın BUTON ROZETİ Beyaz	55-110	160,00 €	1	250 ADET
ONKA-8923-3050OK	→	30X50 mm Orta Kalın BUTON ROZETİ Kırmızı	55-110	160,00 €	1	250 ADET
ONKA-8923-3050OS	→	30X50 mm Orta Kalın BUTON ROZETİ Sarı	55-110	160,00 €	1	250 ADET
ONKA-8923-3050OM	→	30X50 mm Orta Kalın BUTON ROZETİ Mavi	55-110	160,00 €	1	250 ADET
ONKA-8923-3050OG	→	30X50 mm Orta Kalın BUTON ROZETİ Gümüş Gri	55-110	160,00 €	1	250 ADET



\*ONKA-8944-.... uygun ribon ile kullanılır.

## GEÇMELİ KABLO ETİKETLERİ

(AYNI RULODA SARI VE BEYAZ)

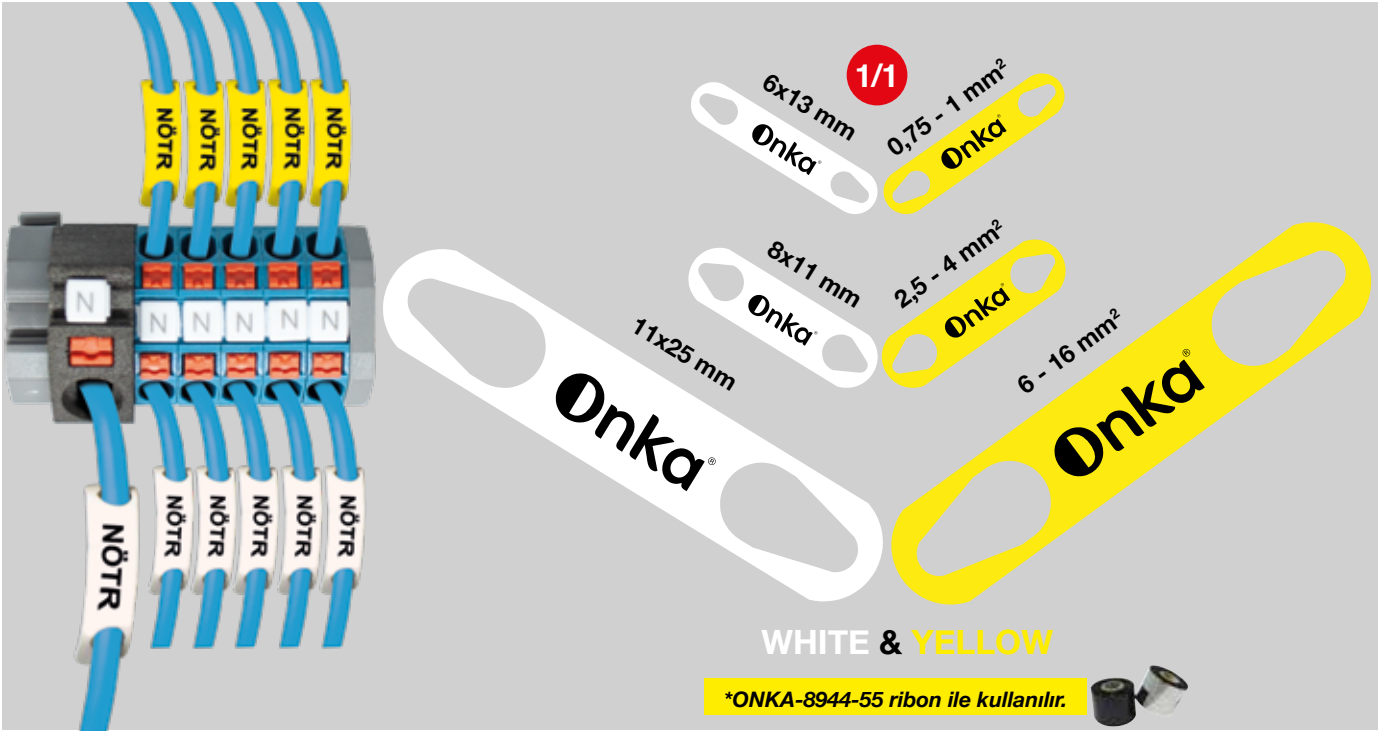

ÜRÜN KODU	RENK	AÇIKLAMA	RULO (€)	SÜTUN SAYISI	RULO ADEDİ
ONKA-8925-613SB		Geçmeli Kablo Etiketi 6x13mm - 0,75/1,5 mm <sup>2</sup> Kablo için Sarı/Beyaz	60,00 €	2	2.000
ONKA-8925-811SB		Geçmeli Kablo Etiketi 8x11mm - 2,5/4 mm <sup>2</sup> Kablo için Sarı/Beyaz	66,00 €	2	2.000
ONKA-8925-1125SB		Geçmeli Kablo Etiketi 11x25mm - 6/16 mm <sup>2</sup> Kablo için Sarı/Beyaz	74,00 €	1	1.000

## KABLOLAMA ÇÖZÜMLERİ (SARMAL KABLO ETİKETLERİ)



ÜRÜN KODU	RENK	AÇIKLAMA	UYGUN RİBON	RULO (€)	SÜTUN SAYISI	RULO ADEDİ
ONKA-8924-1510B		15x10 mm (1.5-2.5-4-6-10mm <sup>2</sup> ) Sarmal Kablo Etiketi BEYAZ	110	100,00 €	4	1000 ADET
ONKA-8924-1915B		19x15 mm (1.5-2.5-4-6 mm <sup>2</sup> ) Sarmal Kablo Etiketi BEYAZ	110	160,00 €	4	2000 ADET
ONKA-8924-1925B		19x25 mm (10-16 mm <sup>2</sup> ) Sarmal Kablo Etiketi BEYAZ	110	210,00 €	3	1500 ADET
ONKA-8924-1938B		19x38 mm (25-35-50 mm <sup>2</sup> ) Sarmal Kablo Etiketi BEYAZ	110	245,00 €	2	2000 ADET
ONKA-8924-1915S		19x15 mm (1.5-2.5-4-6 mm <sup>2</sup> ) Sarmal Kablo Etiketi SARI	110	150,00 €	4	2000 ADET
ONKA-8924-1925S		19x25 mm (10 -16 mm <sup>2</sup> ) Sarmal Kablo Etiketi SARI	110	250,00 €	3	1500 ADET
ONKA-8924-1938S		19x38 mm (25-35-50 mm <sup>2</sup> ) Sarmal Kablo Etiketi SARI	110	280,00 €	2	2000 ADET
ONKA-8924-38180S		38x180 mm Sarmal Kablo Etiketi SARI	110	260,00 €	2	720 ADET



## KABLOLAMA ÇÖZÜMLERİ (ŞEFFAF TÜP ETİKETLERİ)

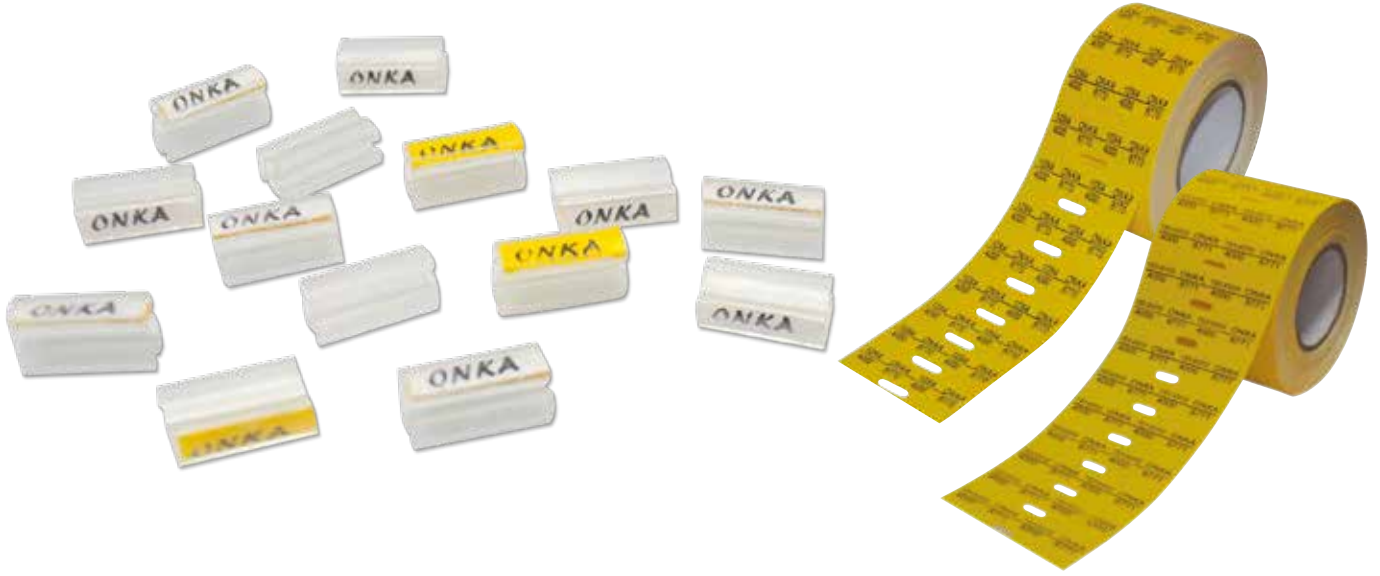

ÜRÜN KODU	RENK	AÇIKLAMA	UYGUN RİBON	RULO (€)	SÜTUN SAYISI	RULO ADEDİ
ONKA-8925-104SB		10x4 mm Şeffaf Tüp Etiketi - BEYAZ	70	140,00 €	4	4000 ADET
ONKA-8925-154SB		15x4 mm Şeffaf Tüp Etiketi - BEYAZ	70	170,00 €	4	4000 ADET
ONKA-8925-204SB		20x4 mm Şeffaf Tüp Etiketi - BEYAZ	70	140,00 €	2	3000 ADET
ONKA-8925-304SB		30x4 mm Şeffaf Tüp Etiketi - BEYAZ	70	170,00 €	2	2500 ADET



\*ONKA-8944-70 ribon ile kullanılır.

## KABLOLAMA ÇÖZÜMLERİ (ŞEFFAF TÜPLER)

ÜRÜN KODU	AÇIKLAMA	KUTU (€)	KUTU ADEDİ
ONKA-8926-101	10 mm Şeffaf Tüp / 0,5-1,5 mm <sup>2</sup> Kablo için	36,00 €	1000 ADET
ONKA-8926-151	15 mm Şeffaf Tüp / 0,5-1,5 mm <sup>2</sup> Kablo için	42,00 €	1000 ADET
ONKA-8926-201	20 mm Şeffaf Tüp / 0,5-1,5 mm <sup>2</sup> Kablo için	25,00 €	500 ADET
ONKA-8926-301	30 mm Şeffaf Tüp / 0,5-1,5 mm <sup>2</sup> Kablo için	32,00 €	500 ADET
ONKA-8926-101.5	10 mm Şeffaf Tüp / 1.5-2.5 mm <sup>2</sup> Kablo İçi	40,00 €	1000 ADET
ONKA-8926-151.5	15 mm Şeffaf Tüp / 1.5-2.5 mm <sup>2</sup> Kablo İçi	47,00 €	1000 ADET
ONKA-8926-201.5	20 mm Şeffaf Tüp / 1.5-2.5 mm <sup>2</sup> Kablo İçi	29,00 €	500 ADET
ONKA-8926-301.5	30 mm Şeffaf Tüp / 1.5-2.5 mm <sup>2</sup> Kablo İçi	37,00 €	500 ADET
ONKA-8926-102	10 mm Şeffaf Tüp / 2,5-4 mm <sup>2</sup> Kablo için	46,00 €	1000 ADET
ONKA-8926-152	15 mm Şeffaf Tüp / 2,5-4 mm <sup>2</sup> Kablo için	54,00 €	1000 ADET
ONKA-8926-202	20 mm Şeffaf Tüp / 2,5-4 mm <sup>2</sup> Kablo için	32,00 €	500 ADET
ONKA-8926-302	30 mm Şeffaf Tüp / 2,5-4 mm <sup>2</sup> Kablo için	42,00 €	500 ADET
ONKA-8926-103	10 mm Şeffaf Tüp / 4-6 mm <sup>2</sup> Kablo için	65,00 €	1000 ADET
ONKA-8926-153	15 mm Şeffaf Tüp / 4-6 mm <sup>2</sup> Kablo için	100,00 €	1000 ADET
ONKA-8926-203	20 mm Şeffaf Tüp / 4-6 mm <sup>2</sup> Kablo için	65,00 €	500 ADET
ONKA-8926-303	30 mm Şeffaf Tüp / 4-6 mm <sup>2</sup> Kablo için	100,00 €	500 ADET

## İNCE PANO ETİKETLERİ

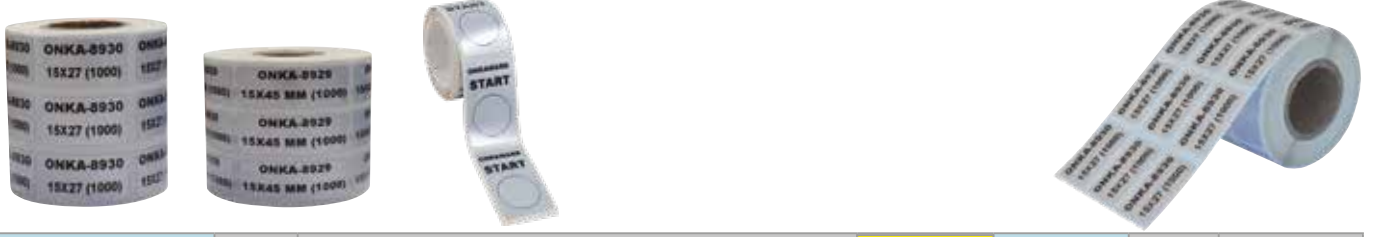

ÜRÜN KODU	RENK	AÇIKLAMA	UYGUN RİBON	RULO (€)	SÜTUN SAYISI	RULO ADEDİ
ONKA-8921-1326SW	⇒	13x26 mm Silvermat İnce Pano Etiketi (EKO)	110	90,00 €	3	1500 ADET
ONKA-8921-1527SW	⇒	15x27 mm Silvermat İnce Pano Etiketi (EKO)	55-110	48,00 €	1	1000 ADET
ONKA-8921-1827SW	⇒	18x27 mm Silvermat İnce Pano Etiketi (EKO)	55-110	80,00 €	1	1500 ADET
ONKA-8921-1545SW	⇒	15x45 mm Silvermat İnce Pano Etiketi (EKO)	55-110	60,00 €	1	1000 ADET
ONKA-8921-6040SW	⇒	60x40 mm Silvermat İnce Pano Etiketi (EKO)	110	260,00 €	1	2000 ADET
ONKA-8921-2575SW	⇒	25x75 mm Silvermat İnce Pano Etiketi (EKO)	110	265,00 €	1	2000 ADET
ONKA-8921-5075SW	⇒	50x75 mm Silvermat İnce Pano Etiketi (EKO)	110	250,00 €	1	1000 ADET
ONKA-8921-40100SW	⇒	40x100 mm Silvermat İnce Pano Etiketi (EKO)	110	190,00 €	1	500 ADET
ONKA-8921-50100SW	⇒	50x100 mm Silvermat İnce Pano Etiketi (EKO)	110	240,00 €	1	1000 ADET
ONKA-8921-80100SW	⇒	80x100 mm Silvermat İnce Pano Etiketi (EKO)	110	135,00 €	1	100 ADET
ONKA-8921-3050SW	⇒	30x50 mm Silvermat BUTON ROZETİ (EKO)	110	42,00 €	1	500 ADET



\*ONKA-8944-... uygun ribon ile kullanılır.

## HAZIR İKAZ ETİKETLERİ VE ÖLÜM TEHLİKE LEVHALARI



ÜRÜN KODU	CINSİ	ADET (t)	PLAKA ADEDİ
ONKA-2473	25 mm Üçgen Etiket (DİKKAT)	4,95 €	1 PLAKA (132 ADET)
ONKA-2474	25 mm Üçgen Etiket (NÖTR)	4,95 €	1 PLAKA (132 ADET)
ONKA-2477	25 mm Üçgen Etiket (TOPRAK)	4,95 €	1 PLAKA (132 ADET)
ONKA-2478	25 mm Üçgen Etiket (FAZ)	4,95 €	1 PLAKA 44 TAKIM (132 ADET)
ONKA-8922-1310SY	PVC Hazır Üçgen Uyarı Etiketi Yapışkanlı 13x10 cm	175,00 €	100 ADET
ONKA-8922-118SY	PVC Hazır Üçgen Uyarı Etiketi Yapışkanlı 11x8 cm	140,00 €	100 ADET
ONKA-8922-2315SY	PVC Hazır Uyarı Etiketi Yapışkanlı 23x15 cm (Ölüm Tehlike Levhası)	280,00 €	100 ADET
ONKA-8922-2315S	PVC Hazır Uyarı Etiketi Yapışkanlı 23x15 cm (Ölüm Tehlike Levhası)	245,00 €	100 ADET



## 20W FİBER LAZER YAZICI

- Yüksek Hızlı Tarayıcı
- Çok Yönlü Uygulama Alanı
- Hızlı ve Hassas Markalama
- Kolay Kullanım & Taşınabilir
- Ekonomik & Enerji Verimliliği
- 100.000 Saat Çalışma Ömrü
- Bakım Gerektirmez
- 110x110 mm İşlem Alanı
- 3 Yıl Garanti

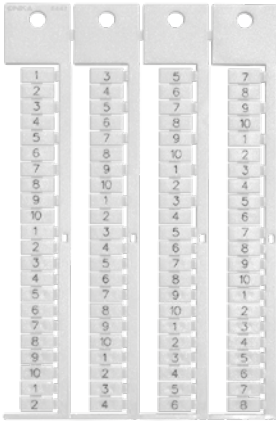
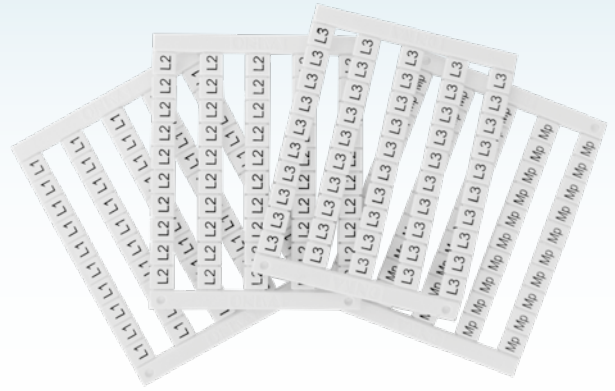

## DEKAFİXLER

### DEKAFİXLER (MRK ve OPK SERİSİ)

ÜRÜN KODU	ESKİ KOD	AÇIKLAMA	ADET (t)	KUTU ADEDİ
1060198	ONKA-5443	OD10-5P Baskısız, Birleşik Kopan (1,5 mm <sup>2</sup> klemens için)	1,71	880
1060199	ONKA-5444	OD10-5P Baskılı, Birleşik Kopan (1,5 mm <sup>2</sup> klemens için)	4,13	880
1060192	ONKA-4440	OD10-6P Baskısız Birleşik Kopan (2,5 mm <sup>2</sup> klemens için)	2,09	720
1060193	ONKA-4441	OD10-6P Baskılı Birleşik Kopan (2,5 mm <sup>2</sup> klemens için)	4,51	720
1060194	ONKA-4442	OD10-6P Baskısız Tek Tek Kopan	2,13	720
1060195	ONKA-4443	OD10-6P Baskılı Tek Tek Kopan	4,55	720
1060190	ONKA-4390	OD10-6P Baskısız, Birleşik Kopan (4 mm <sup>2</sup> klemens için)	2,22	640
1060191	ONKA-4391	OD10-6P Baskılı, Birleşik Kopan (4 mm <sup>2</sup> klemens için)	4,64	640
1060188	ONKA-2630	OD10-8P Baskısız, Birleşik Kopan (6 -10 mm <sup>2</sup> ve üzeri klemens için)	2,65	560
1060189	ONKA-2631	OD10-8P Baskılı, Birleşik Kopan (6 -10 mm <sup>2</sup> ve üzeri klemens için)	5,07	560

**DEKAFİX (MRK ve OPK SERİSİ)**
**OD5-5**

ÜRÜN KODU	BASKI	ADET (t)
1060200	BASKISIZ	1,27
1060201	ÖZEL BASKILI	3,18
1060212	0	1,91
1060213	1	1,91
1060214	2	1,91
1060215	3	1,91
1060216	4	1,91
1060217	5	1,91
1060218	6	1,91
1060219	7	1,91
1060220	8	1,91
1060221	9	1,91
1060222	10	1,91
1060223	1-10	1,91
1060224	11-20	1,91
1060225	21-30	1,91
1060226	31-40	1,91
1060227	41-50	1,91
1060228	51-60	1,91
1060229	61-70	1,91
1060230	71-80	1,91
1060231	81-90	1,91
1060232	91-100	1,91
1060233	101-110	1,91
1060234	111-120	1,91
1060235	121-130	1,91
1060236	131-140	1,91
1060237	141-150	1,91
1060238	151-160	1,91
1060239	161-170	1,91
1060240	171-180	1,91
1060241	181-190	1,91
1060242	191-200	1,91
1060243	10,20,...,100	1,91
1060244	1-50	1,91
1060245	51-100	1,91
1060246	101-150	1,91
1060247	151-200	1,91
1060248	201-250	1,91
1060249	251-300	1,91
1060250	301-350	1,91
1060251	351-400	1,91
1060252	401-450	1,91
1060253	451-500	1,91

ÜRÜN KODU	BASKI	ADET (t)
1060254	501-550	1,91
1060255	551-600	1,91
1060256	601-650	1,91
1060257	651-700	1,91
1060258	701-750	1,91
1060259	751-800	1,91
1060260	801-850	1,91
1060261	851-900	1,91
1060262	901-950	1,91
1060263	951-999	1,91
1060264	+	1,91
1060265	-	1,91
1060266	⊕	1,91
1060267	Mp	1,91
1060268	PE	1,91
1060269	L1	1,91
1060270	L2	1,91
1060271	L3	1,91
1060272	A	1,91
1060273	B	1,91
1060274	C	1,91
1060275	D	1,91
1060276	E	1,91
1060277	F	1,91
1060278	G	1,91
1060279	H	1,91
1060280	I	1,91
1060281	J	1,91
1060282	K	1,91
1060283	L	1,91
1060284	M	1,91
1060285	N	1,91
1060286	O	1,91
1060287	P	1,91
1060288	Q	1,91
1060289	R	1,91
1060290	S	1,91
1060291	T	1,91
1060292	U	1,91
1060293	V	1,91
1060294	W	1,91
1060295	X	1,91
1060296	Y	1,91
1060297	Z	1,91

**DEKAFİX (MRK ve OPK SERİSİ)**
**OD10 (1,5 mm<sup>2</sup>)**

ÜRÜN KODU	BASKI	ADET (t)
1060298	BASKISIZ	1,70
1060508	ÖZEL BASKILI	4,25
1060299	0	2,78
1060300	1	2,78
1060301	2	2,78
1060302	3	2,78
1060303	4	2,78
1060304	5	2,78
1060305	6	2,78
1060306	7	2,78
1060307	8	2,78
1060308	9	2,78
1060309	10	2,78
1060310	1-10	2,78
1060311	11-20	2,78
1060312	21-30	2,78
1060313	31-40	2,78
1060314	41-50	2,78
1060315	51-60	2,78
1060316	61-70	2,78
1060317	71-80	2,78
1060318	81-90	2,78
1060319	91-100	2,78
1060320	101-110	2,78
1060321	111-120	2,78
1060322	121-130	2,78
1060323	131-140	2,78
1060324	141-150	2,78
1060325	151-160	2,78
1060326	161-170	2,78
1060327	171-180	2,78
1060328	181-190	2,78
1060329	191-200	2,78
1060330	10,20,...,100	2,78

ÜRÜN KODU	BASKI	ADET (t)
1060331	+	2,78
1060332	-	2,78
1060333	⊕	2,78
1060334	Mp	2,78
1060335	PE	2,78
1060336	L1	2,78
1060337	L2	2,78
1060338	L3	2,78
1060339	A	2,78
1060340	B	2,78
1060341	C	2,78
1060342	D	2,78
1060343	E	2,78
1060344	F	2,78
1060345	G	2,78
1060346	H	2,78
1060347	I	2,78
1060348	J	2,78
1060349	K	2,78
1060350	L	2,78
1060351	M	2,78
1060352	N	2,78
1060353	O	2,78
1060354	P	2,78
1060355	Q	2,78
1060356	R	2,78
1060357	S	2,78
1060358	T	2,78
1060359	U	2,78
1060360	V	2,78
1060361	W	2,78
1060362	X	2,78
1060363	Y	2,78
1060364	Z	2,78



**DEKAFİX (MRK ve OPK SERİSİ) OD10 (2,5 mm<sup>2</sup>)**

ÜRÜN KODU	BASKI	ADET (t)	ÜRÜN KODU	BASKI	ADET (t)
1060365	BASKISIZ	2,16	1060398	+	3,23
1060509	ÖZEL BASKILI	5,40	1060399	-	3,23
1060366	0	3,23	1060400	⚡	3,23
1060367	1	3,23	1060401	Mp	3,23
1060368	2	3,23	1060402	PE	3,23
1060369	3	3,23	1060403	L1	3,23
1060370	4	3,23	1060404	L2	3,23
1060371	5	3,23	1060405	L3	3,23
1060372	6	3,23	1060406	A	3,23
1060373	7	3,23	1060407	B	3,23
1060374	8	3,23	1060408	C	3,23
1060375	9	3,23	1060409	D	3,23
1060376	10	3,23	1060410	E	3,23
1060377	1-10	3,23	1060411	F	3,23
1060378	11-20	3,23	1060412	G	3,23
1060379	21-30	3,23	1060413	H	3,23
1060380	31-40	3,23	1060414	I	3,23
1060381	41-50	3,23	1060415	J	3,23
1060382	51-60	3,23	1060416	K	3,23
1060383	61-70	3,23	1060417	L	3,23
1060384	71-80	3,23	1060418	M	3,23
1060385	81-90	3,23	1060419	N	3,23
1060386	91-100	3,23	1060420	O	3,23
1060387	101-110	3,23	1060421	P	3,23
1060388	111-120	3,23	1060422	Q	3,23
1060389	121-130	3,23	1060423	R	3,23
1060390	131-140	3,23	1060424	S	3,23
1060391	141-150	3,23	1060425	T	3,23
1060392	151-160	3,23	1060426	U	3,23
1060393	161-170	3,23	1060427	V	3,23
1060394	171-180	3,23	1060428	W	3,23
1060395	181-190	3,23	1060429	X	3,23
1060396	191-200	3,23	1060430	Y	3,23
1060397	10,20,....,100	3,23	1060431	Z	3,23

\* OD10 Serisi Dekafix Kutu Miktarı 300 Adettir.

**DEKAFİX (MRK ve OPK SERİSİ) OD10 (4 mm<sup>2</sup>)**

ÜRÜN KODU	BASKI	ADET (t)	ÜRÜN KODU	BASKI	ADET (t)
1060432	BASKISIZ	2,74	1060465	+	3,81
1060510	ÖZEL BASKILI	6,85	1060466	-	3,81
1060433	0	3,81	1060467	⚡	3,81
1060434	1	3,81	1060468	Mp	3,81
1060435	2	3,81	1060469	PE	3,81
1060436	3	3,81	1060470	L1	3,81
1060437	4	3,81	1060471	L2	3,81
1060438	5	3,81	1060472	L3	3,81
1060439	6	3,81	1060473	A	3,81
1060440	7	3,81	1060474	B	3,81
1060441	8	3,81	1060475	C	3,81
1060442	9	3,81	1060476	D	3,81
1060443	10	3,81	1060477	E	3,81
1060444	1-10	3,81	1060478	F	3,81
1060445	11-20	3,81	1060479	G	3,81
1060446	21-30	3,81	1060480	H	3,81
1060447	31-40	3,81	1060481	I	3,81
1060448	41-50	3,81	1060482	J	3,81
1060449	51-60	3,81	1060483	K	3,81
1060450	61-70	3,81	1060484	L	3,81
1060451	71-80	3,81	1060485	M	3,81
1060452	81-90	3,81	1060486	N	3,81
1060453	91-100	3,81	1060487	O	3,81
1060454	101-110	3,81	1060488	P	3,81
1060455	111-120	3,81	1060489	Q	3,81
1060456	121-130	3,81	1060490	R	3,81
1060457	131-140	3,81	1060491	S	3,81
1060458	141-150	3,81	1060492	T	3,81
1060459	151-160	3,81	1060493	U	3,81
1060460	161-170	3,81	1060494	V	3,81
1060461	171-180	3,81	1060495	W	3,81
1060462	181-190	3,81	1060496	X	3,81
1060463	191-200	3,81	1060497	Y	3,81
1060464	10,20,....,100	3,81	1060498	Z	3,81

\* OD10 Serisi Dekafix Kutu Miktarı 300 Adettir.

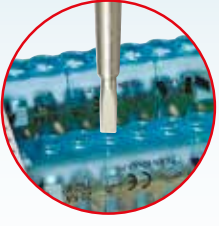

Kapak sökmeden  
montaj



Kapak sökmeden  
Kablo giriş



Zemine  
ve raya montaj

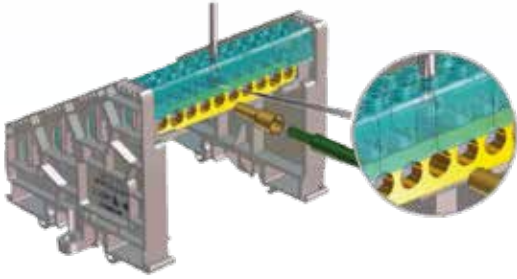
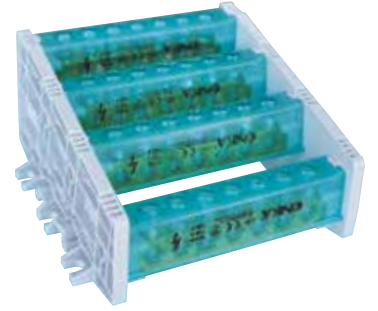
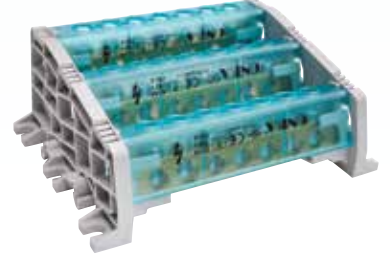
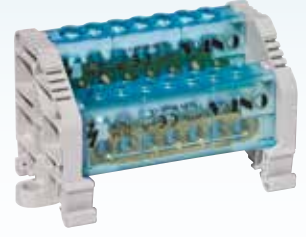
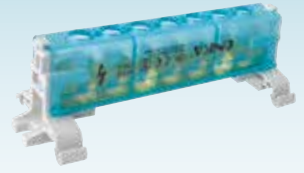

## DAĞITICI ÜNİTELER

### Pano ve bağlantı kutuları içinde ;

- Güvenli,
- Ergonomik
- Estetik bağlantılarla kayıpsız enerji dağıtım ve toplama.
- Yüksek kısadevre gücü ve dielektrik yapısı ile maksimum pano, tesis ve personel güvenliği.
- Yetkisiz personel ve canlılar için kazara dokunmalara karşı ekstra emniyet ve formlama kabiliyeti. (FORM-2 / FORM2-B)
- Yenilenebilir enerji sektörü AC/DC Toplama panoları için ideal kompakt çözüm, 1500V-DC gerilimi dayanımı.



### MS 58 !

Bakır(Cu) ve çinko(Zn) değişik oranlarda birleştirilerek yapılan alaşımlara pirinç adı verilir. Mukavemet ve korozyon dayanım özellikleri çok yüksek olan pirinçlerin, iç yapı ve mekanik özellikleri çinko miktarıyla orantılıdır. Elektroteknik sektörü ürünleri için gereken iletkenliğin sağlanması ise bakır miktarıyla doğru orantılıdır. Bağlantı noktalarının vida sıkma mukavemeti için gerekli sertlik ve iletkenliğin ideal oranı, bakır miktarı %58 den az olmamak üzere MS 58 ile sağlanmaktadır.

### TEKNİK ÖZELLİKLER

KESİT ÖLÇÜLERİ (mm)	KÜÇÜK DELİK ÇAPI (mm)	BÜYÜK DELİK ÇAPI (mm)	AKIM (A)	TEK DAMAR KABLO KESİTİ (mm <sup>2</sup> )	ÇOK TELLİ KABLO KESİTİ (mm <sup>2</sup> )
6,5 x 9	4,8	5,5	80	16 mm <sup>2</sup>	10 mm <sup>2</sup>
7 x 12	6	7,5	160	25 mm <sup>2</sup>	25 mm <sup>2</sup>
10 x 15	8,5	10,3	250	50 mm <sup>2</sup>	50 mm <sup>2</sup>

## PANO TOPRAKLAMA KLEMENSLERİ

### 80 AMPER (A:9 x B:6,5 mm)

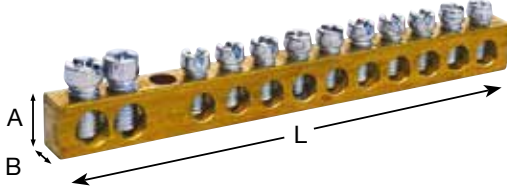

Çok Telli Kablo kesiti max. 10 mm<sup>2</sup>  
Tek Damarlı Kablo kesiti max. 16 mm<sup>2</sup>

ÜRÜN KODU	ESKİ KOD	CİNSİ	L ± 2	ADET (t)	K. AD.
1080101	ONKA - 2001	2/3 = 5 Delikli Pano Top. Klemensi	42	84,65	50
1080102	ONKA - 2002	2/5 = 7 Delikli Pano Top. Klemensi	54	110,80	50
1080103	ONKA - 2003	2/8 = 10 Delikli Pano Top. Klemensi	73	150,25	50
1080104	ONKA - 2004	2/10 = 12 Delikli Pano Top. Klemensi	86	174,00	50
1080105	ONKA - 2005	2/13 = 15 Delikli Pano Top. Klemensi	105	212,35	50
1080106	ONKA - 2006	2/20 = 22 Delikli Pano Top. Klemensi	148	301,70	50
1080107	ONKA - 2007	2/40 = 42 Delikli Pano Top. Klemensi	285	566,50	50
1080108	ONKA - 2008	2/60 = 62 Delikli Pano Top. Klemensi	410	810,05	50
1080110	ONKA - 1999	1 metre, 159 Delikli Pano Top. Klemensi	1000	1.772,00	1

### 160 AMPER (A:12 x B:7 mm)

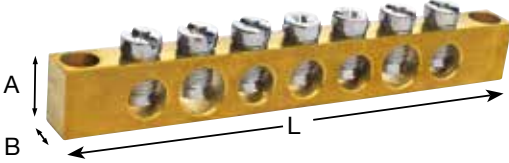

Kablo kesiti max. 25 mm<sup>2</sup>

ÜRÜN KODU	ESKİ KOD	CİNSİ	L ± 2	ADET (t)	K. AD.
1080115	ONKA - 2021	2/5 = 7 Delikli Pano Top. Klemensi	69	150,00	50
1080116	ONKA - 2022	2/8 = 10 Delikli Pano Top. Klemensi	93	210,90	50
1080117	ONKA - 2023	2/10 = 12 Delikli Pano Top. Klemensi	119	251,65	50
1080118	ONKA - 2024	2/13 = 15 Delikli Pano Top. Klemensi	133	302,55	50
1080119	ONKA - 2025	2/20 = 22 Delikli Pano Top. Klemensi	188	434,90	50
1080121	ONKA - 2029	1 metre, 126 Delikli Pano Top. Klemensi	1000	2.211,00	1

### 250 AMPER (A:15 x B:10 mm)

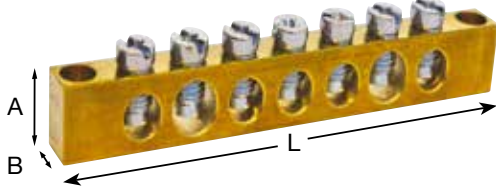

Kablo kesiti max. 50 mm<sup>2</sup>

ÜRÜN KODU	ESKİ KOD	CİNSİ	L ± 2	ADET (t)	K. AD.
1080123	ONKA - 2041	2/5 = 7 Delikli Pano Top. Klemensi	69	436,80	50
1080124	ONKA - 2042	2/8 = 10 Delikli Pano Top. Klemensi	93	592,85	50
1080125	ONKA - 2043	2/10 = 12 Delikli Pano Top. Klemensi	119	722,70	50
1080126	ONKA - 2044	2/13 = 15 Delikli Pano Top. Klemensi	133	901,65	50
1080127	ONKA - 2045	2/20 = 22 Delikli Pano Top. Klemensi	188	1.319,00	50
1080128	ONKA - 2028	1 metre, 79 Delikli Pano Top. Klemensi	1000	4.020,00	1

## 1 KUTUPLU DAĞITICI ÜNİTELER

Raya montajlı kullanım için ray siparişi ayrıca verilmelidir.

### 80 AMPER (A:9 x B:6,5 mm)

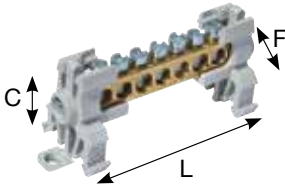

Çok Telli Kablo kesiti max. 10 mm<sup>2</sup>  
Tek Damarlı Kablo kesiti max. 16 mm<sup>2</sup>

ÜRÜN KODU	ESKİ KOD	CİNSİ	L ± 2	F ± 1	C ± 1	ADET (t)	K. AD.
1080001	ONKA - 2051	2 / 5 - 7 Delikli	71,4	24	28,2	135,50	32
1080002	ONKA - 2052	2 / 8 - 10 Delikli	89,9	24	28,2	170,40	24
1080003	ONKA - 2053	2 / 10 - 12 Delikli	102,4	24	28,2	194,60	18
1080004	ONKA - 2054	2 / 13 - 15 Delikli	120,9	24	28,2	230,75	16
1080005	ONKA - 2055	2 / 20 - 22 Delikli	164,9	24	28,2	315,20	12

### 160 AMPER (A:12 x B:7 mm)

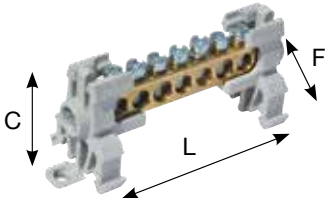

Kablo kesiti max. 25 mm<sup>2</sup>

ÜRÜN KODU	ESKİ KOD	CİNSİ	L ± 2	F ± 1	C ± 1	ADET (t)	K. AD.
1080006	ONKA - 2056	2 / 5 - 7 Delikli	83	24	28,2	193,90	32
1080007	ONKA - 2057	2 / 8 - 10 Delikli	106,7	24	28,2	244,20	24
1080008	ONKA - 2058	2 / 10 - 12 Delikli	122,5	24	28,2	278,60	18
1080009	ONKA - 2059	2 / 13 - 15 Delikli	146,1	24	28,2	333,25	16
1080010	ONKA - 2060	2 / 20 - 22 Delikli	200,9	24	28,2	453,95	12

### 250 AMPER (A:15 x B:10 mm)

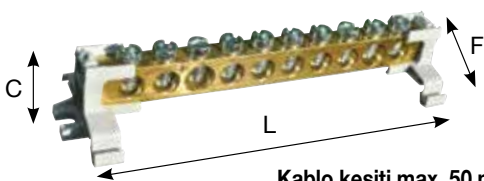

Kablo kesiti max. 50 mm<sup>2</sup>

ÜRÜN KODU	ESKİ KOD	CİNSİ	L ± 2	F ± 1	C ± 1	ADET (t)	K. AD.
1080016	ONKA - 2066	2 / 5 - 7 Delikli	121	43,2	39	446,80	32
1080017	ONKA - 2067	2 / 8 - 10 Delikli	159	43,2	39	596,70	24
1080018	ONKA - 2068	2 / 10 - 12 Delikli	184	43,2	39	706,75	18
1080019	ONKA - 2069	2 / 13 - 15 Delikli	220,5	43,2	39	868,70	16
1080020	ONKA - 2070	2 / 20 - 22 Delikli	308	43,2	39	1.237,40	12

## 1 KUTUPLU DAĞITICI ÜNİTELER (KAPAKLI SİSTEM)

Raya montajlı kullanım için ray siparişi ayrıca verilmelidir.

### 80 AMPER (A:9 x B:6,5 mm)

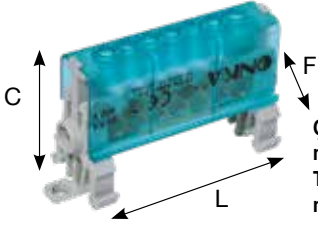

Çok Telli Kablo kesiti  
max. 10 mm<sup>2</sup>  
Tek Damarlı Kablo kesiti  
max. 16 mm<sup>2</sup>

ÜRÜN KODU	ESKİ KOD	CİNSİ	L ± 2	F ± 1	C ± 1	ADET (t)	K. AD.
1080011	ONKA - 2061	2 / 5 - 7 Delikli	71,4	24	37,5	147,45	32
1080012	ONKA - 2062	2 / 8 - 10 Delikli	89,9	24	37,5	183,95	24
1080013	ONKA - 2063	2 / 10 - 12 Delikli	102,4	24	37,5	209,40	18
1080014	ONKA - 2064	2 / 13 - 15 Delikli	120,9	24	37,5	249,50	16
1080015	ONKA - 2065	2 / 20 - 22 Delikli	164,9	24	28,2	338,00	12

### 160 AMPER (A:12 x B:7 mm)

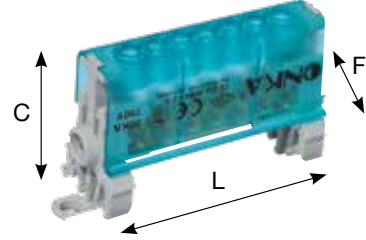

Kablo kesiti  
max. 25 mm<sup>2</sup>

ÜRÜN KODU	ESKİ KOD	CİNSİ	L ± 2	F ± 1	C ± 1	ADET (t)	K. AD.
1080021	ONKA - 2071	2 / 5 - 7 Delikli	83	24	37,5	213,45	32
1080022	ONKA - 2072	2 / 8 - 10 Delikli	106,7	24	37,5	266,10	24
1080023	ONKA - 2073	2 / 10 - 12 Delikli	122,5	24	37,5	302,00	18
1080024	ONKA - 2074	2 / 13 - 15 Delikli	146,1	24	37,5	360,50	16
1080025	ONKA - 2075	2 / 20 - 22 Delikli	200,9	24	37,5	485,55	12

### 250 AMPER (A:15 x B:10 mm)

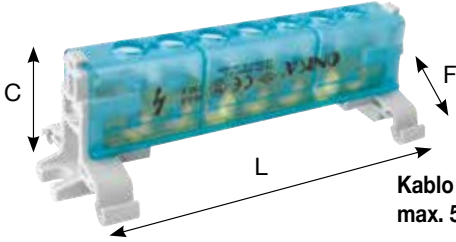

Kablo kesiti  
max. 50 mm<sup>2</sup>

ÜRÜN KODU	ESKİ KOD	CİNSİ	L ± 2	F ± 1	C ± 1	ADET (t)	K. AD.
1080026	ONKA - 2076	2 / 5 - 7 Delikli	121	43,2	38	465,95	32
1080027	ONKA - 2077	2 / 8 - 10 Delikli	159	43,2	38	619,60	24
1080028	ONKA - 2078	2 / 10 - 12 Delikli	184	43,2	38	731,70	18
1080029	ONKA - 2079	2 / 13 - 15 Delikli	220,5	43,2	38	896,10	16
1080030	ONKA - 2080	2 / 20 - 22 Delikli	308	43,2	38	1.270,00	12

## 2 KUTUPLU DAĞITICI ÜNİTELER (KAPAKLI SİSTEM)

Raya montajlı kullanım için ray siparişi ayrıca verilmelidir.

### 80 AMPER (A:9 x B:6,5 mm)

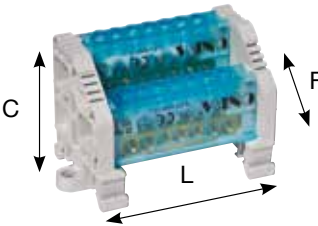

Çok Telli Kablo kesiti  
max. 10 mm<sup>2</sup>  
Tek Damarlı Kablo  
kesiti max. 16 mm<sup>2</sup>

ÜRÜN KODU	ESKİ KOD	CİNSİ	L ± 2	F ± 1	C ± 1	ADET (t)	K. AD.
1080031	ONKA - 2081	2 / 5 - 7 Delikli	82,7	50,8	46,6	318,15	1
1080032	ONKA - 2082	2 / 8 - 10 Delikli	101,7	50,8	46,6	392,30	1
1080033	ONKA - 2083	2 / 10 - 12 Delikli	114,2	50,8	46,6	444,30	1
1080034	ONKA - 2084	2 / 13 - 15 Delikli	132,7	50,8	46,6	527,10	1
1080035	ONKA - 2085	2 / 20 - 22 Delikli	176,5	50,8	46,6	705,40	1

### 160 AMPER (A:12 x B:7 mm)

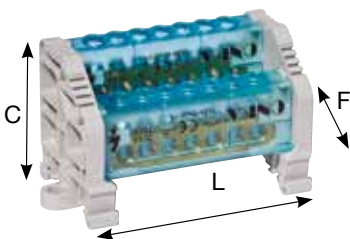

Kablo kesiti  
max. 25 mm<sup>2</sup>

ÜRÜN KODU	ESKİ KOD	CİNSİ	L ± 2	F ± 1	C ± 1	ADET (t)	K. AD.
1080041	ONKA - 2091	2 / 5 - 7 Delikli	95,2	50,8	46,6	382,50	1
1080042	ONKA - 2092	2 / 8 - 10 Delikli	118,7	50,8	46,6	490,30	1
1080043	ONKA - 2093	2 / 10 - 12 Delikli	134,2	50,8	46,6	563,10	1
1080044	ONKA - 2094	2 / 13 - 15 Delikli	157,2	50,8	46,6	682,90	1
1080045	ONKA - 2095	2 / 20 - 22 Delikli	212,2	50,8	46,6	933,80	1

### 250 AMPER (A:15 x B:10 mm)

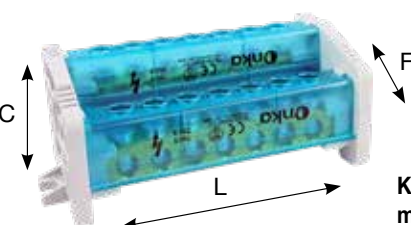

Kablo kesiti  
max. 50 mm<sup>2</sup>

ÜRÜN KODU	ESKİ KOD	CİNSİ	L ± 2	F ± 1	C ± 1	ADET (t)	K. AD.
1080036	ONKA - 2086	2 / 5 - 7 Delikli	135	55	50	1.088,00	1
1080037	ONKA - 2087	2 / 8 - 10 Delikli	172,5	55	50	1.381,00	1
1080038	ONKA - 2088	2 / 10 - 12 Delikli	197	55	50	1.621,00	1
1080039	ONKA - 2089	2 / 13 - 15 Delikli	235	55	50	1.949,00	1
1080040	ONKA - 2090	2 / 20 - 22 Delikli	322,5	55	50	2.778,00	1

## 3 KUTUPLU DAĞITICI ÜNİTELER (KAPAKLI SİSTEM)

Raya montajlı kullanım için ray siparişi ayrıca verilmelidir.

### 80 AMPER (A:9 x B:6,5 mm)

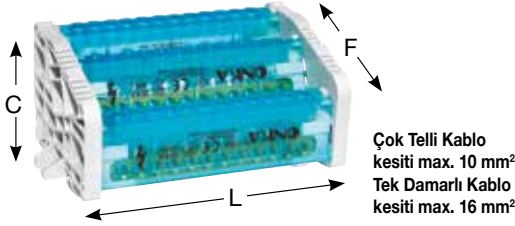
 Çok Tellî Kablo  
kesiti max. 10 mm<sup>2</sup>  
Tek Damarlı Kablo  
kesiti max. 16 mm<sup>2</sup>

ÜRÜN KODU	ESKİ KOD	CİNSİ	L ± 2	F ± 1	C ± 1	ADET (t)	K. AD.
1080066	ONKA - 2171	2 / 5 - 7 Delikli	82,7	66	47	481,00	1
1080067	ONKA - 2172	2 / 8 - 10 Delikli	101,6	66	47	600,00	1
1080068	ONKA - 2173	2 / 10 - 12 Delikli	113,9	66	47	686,00	1
1080069	ONKA - 2174	2 / 13 - 15 Delikli	132,8	66	47	818,00	1
1080070	ONKA - 2175	2 / 20 - 22 Delikli	176,5	66	47	1.108,00	1

### 160 AMPER (A:12 x B:7 mm)

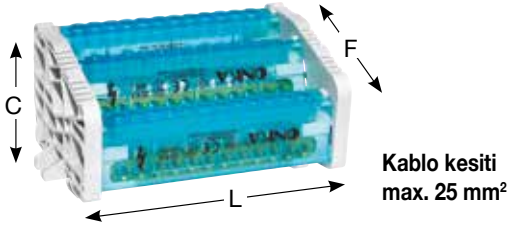
 Kablo kesiti  
max. 25 mm<sup>2</sup>

ÜRÜN KODU	ESKİ KOD	CİNSİ	L ± 2	F ± 1	C ± 1	ADET (t)	K. AD.
1080061	ONKA - 2151	2 / 5 - 7 Delikli	95	66	47	650,00	1
1080062	ONKA - 2152	2 / 8 - 10 Delikli	118,5	66	47	840,00	1
1080063	ONKA - 2153	2 / 10 - 12 Delikli	134	66	47	973,00	1
1080064	ONKA - 2154	2 / 13 - 15 Delikli	157	66	47	1.141,00	1
1080065	ONKA - 2155	2 / 20 - 22 Delikli	212	66	47	1.553,00	1

### 250 AMPER (A:15 x B:10 mm)

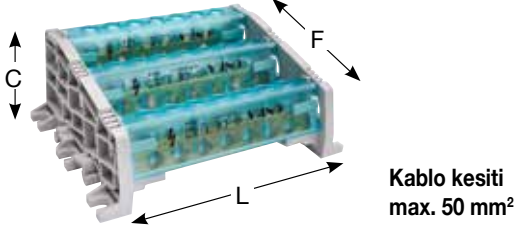
 Kablo kesiti  
max. 50 mm<sup>2</sup>

ÜRÜN KODU	ESKİ KOD	CİNSİ	L ± 2	F ± 1	C ± 1	ADET (t)	K. AD.
1080071	ONKA - 2181	2 / 5 - 7 Delikli	117	94,5	50	1.555,00	1
1080072	ONKA - 2182	2 / 8 - 10 Delikli	154,5	94,5	50	1.995,00	1
1080073	ONKA - 2183	2 / 10 - 12 Delikli	179	94,5	50	2.358,00	1
1080074	ONKA - 2184	2 / 13 - 15 Delikli	217	94,5	50	2.849,00	1
1080075	ONKA - 2185	2 / 20 - 22 Delikli	304,5	94,5	50	4.092,00	1

### 250 AMPER (A:15 x B:10 mm) Yüksek Model

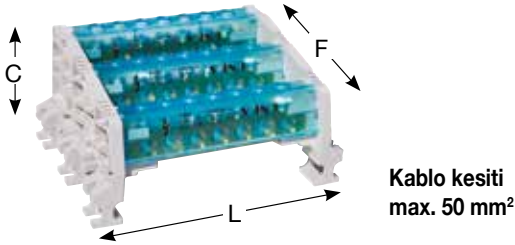

 Kablo kesiti  
max. 50 mm<sup>2</sup>

ÜRÜN KODU	ESKİ KOD	CİNSİ	L ± 2	F ± 1	C ± 1	ADET (t)	K. AD.
1080076	ONKA - 2186	2 / 5 - 7 Delikli	135	95	65	1.710,00	1
1080077	ONKA - 2187	2 / 8 - 10 Delikli	172,5	95	65	2.195,00	1
1080078	ONKA - 2188	2 / 10 - 12 Delikli	197	95	65	2.596,00	1
1080079	ONKA - 2189	2 / 13 - 15 Delikli	235	95	65	3.142,00	1
1080080	ONKA - 2190	2 / 20 - 22 Delikli	322,5	95	65	4.420,00	1

## 4 KUTUPLU DAĞITICI ÜNİTELER (KAPAKLI SİSTEM)

Raya montajlı kullanım için ray siparişi ayrıca verilmelidir.

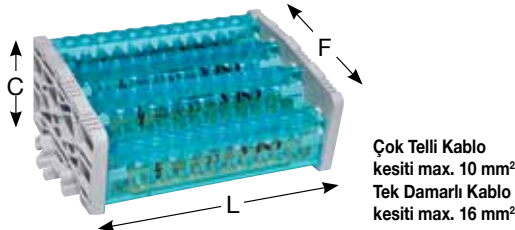
### 80 AMPER (A:9 x B:6,5 mm)

 Çok Tellî Kablo  
kesiti max. 10 mm<sup>2</sup>  
Tek Damarlı Kablo  
kesiti max. 16 mm<sup>2</sup>

ÜRÜN KODU	ESKİ KOD	CİNSİ	L ± 2	F ± 1	C ± 1	ADET (t)	K. AD.
1080086	ONKA - 2201	2 / 5 - 7 Delikli	85,8	86	48,5	640,00	1
1080087	ONKA - 2202	2 / 8 - 10 Delikli	104,7	86	48,5	797,00	1
1080088	ONKA - 2203	2 / 10 - 12 Delikli	117	86	48,5	909,00	1
1080089	ONKA - 2204	2 / 13 - 15 Delikli	135,9	86	48,5	1.085,00	1
1080090	ONKA - 2205	2 / 20 - 22 Delikli	179,6	86	48,5	1.472,00	1

### 160 AMPER (A:12 x B:7 mm)

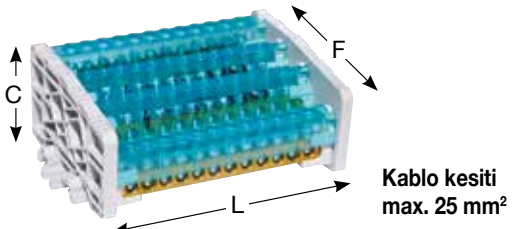

 Kablo kesiti  
max. 25 mm<sup>2</sup>

ÜRÜN KODU	ESKİ KOD	CİNSİ	L ± 2	F ± 1	C ± 1	ADET (t)	K. AD.
1080091	ONKA - 2211	2 / 5 - 7 Delikli	97,7	86	48,5	823,00	1
1080092	ONKA - 2212	2 / 8 - 10 Delikli	121,2	86	48,5	1.077,00	1
1080093	ONKA - 2213	2 / 10 - 12 Delikli	136,7	86	48,5	1.250,00	1
1080094	ONKA - 2214	2 / 13 - 15 Delikli	159,7	86	48,5	1.470,00	1
1080095	ONKA - 2215	2 / 20 - 22 Delikli	214,7	86	48,5	2.022,00	1

## 4 KUTUPLU DAĞITICI ÜNİTELER (KAPAKLI SİSTEM)

Raya montajlı kullanım için ray siparişi ayrıca verilmelidir.

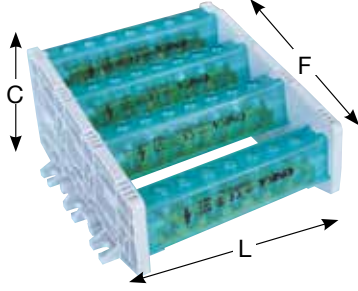
250 AMPER (A:15 x B:10 mm)



Kablo kesiti  
max. 50 mm<sup>2</sup>

ÜRÜN KODU	ESKİ KOD	CİNSİ	L ± 2	F ± 1	C ± 1	ADET (t)	K. AD.
1080056	ONKA - 2116	2 / 5 - 7 Delikli	135,5	130	68	1.985,00	1
1080057	ONKA - 2117	2 / 8 - 10 Delikli	172,6	130	68	2.552,00	1
1080058	ONKA - 2118	2 / 10 - 12 Delikli	197	130	68	3.012,00	1
1080059	ONKA - 2119	2 / 13 - 15 Delikli	235	130	68	3.746,00	1
1080060	ONKA - 2120	2 / 20 - 22 Delikli	322,5	130	68	5.250,00	1

80 AMPER (A:9 x B:6,5 mm)

**Yüksek Model**

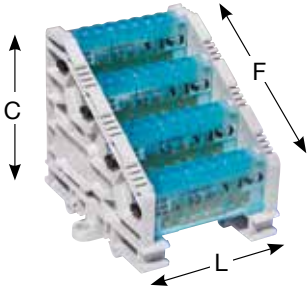

Çok Telli Kablo  
kesiti max. 10 mm<sup>2</sup>  
Tek Damarlı Kablo  
kesiti max. 16 mm<sup>2</sup>

ÜRÜN KODU	ESKİ KOD	CİNSİ	L ± 2	F ± 1	C ± 1	ADET (t)	K. AD.
1080046	ONKA - 2101	2 / 5 - 7 Delikli	84,3	86,5	82,3	636,50	1
1080047	ONKA - 2102	2 / 8 - 10 Delikli	103,2	86,5	82,3	782,00	1
1080048	ONKA - 2103	2 / 10 - 12 Delikli	115,5	86,5	82,3	885,00	1
1080049	ONKA - 2104	2 / 13 - 15 Delikli	134,4	86,5	82,3	1.047,00	1
1080050	ONKA - 2105	2 / 20 - 22 Delikli	178,1	86,5	82,3	1.402,00	1

160 AMPER (A:12 x B:7 mm)

**Yüksek Model**

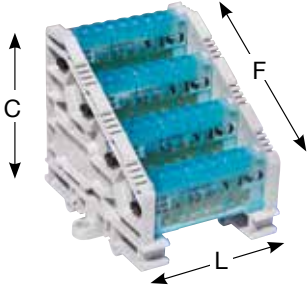

Kablo kesiti  
max. 25 mm<sup>2</sup>

ÜRÜN KODU	ESKİ KOD	CİNSİ	L ± 2	F ± 1	C ± 1	ADET (t)	K. AD.
1080051	ONKA - 2111	2 / 5 - 7 Delikli	95,5	86,5	82,3	785,00	1
1080052	ONKA - 2112	2 / 8 - 10 Delikli	119,5	86,5	82,3	998,00	1
1080053	ONKA - 2113	2 / 10 - 12 Delikli	135	86,5	82,3	1.111,00	1
1080054	ONKA - 2114	2 / 13 - 15 Delikli	158	86,5	82,3	1.376,00	1
1080055	ONKA - 2115	2 / 20 - 22 Delikli	213	86,5	82,3	1.880,00	1

## 5 KUTUPLU DAĞITICI ÜNİTELER (KAPAKLI SİSTEM)

Raya montajlı kullanım için ray siparişi ayrıca verilmelidir.

250 AMPER (A:15 x B:10 mm)

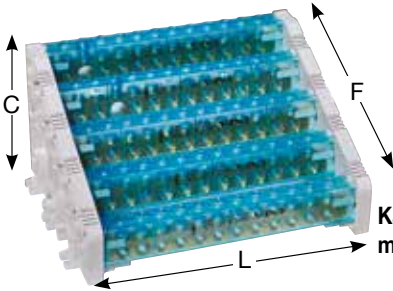

Kablo kesiti  
max. 50 mm<sup>2</sup>

ÜRÜN KODU	ESKİ KOD	CİNSİ	L ± 2	F ± 1	C ± 1	ADET (t)	K. AD.
1080081	ONKA - 2191	2 / 5 - 7 Delikli	143	150	96	2.380,00	1
1080082	ONKA - 2192	2 / 8 - 10 Delikli	180,5	150	96	3.088,00	1
1080083	ONKA - 2193	2 / 10 - 12 Delikli	205	150	96	3.673,00	1
1080084	ONKA - 2194	2 / 13 - 15 Delikli	243	150	96	4.590,00	1
1080085	ONKA - 2195	2 / 20 - 22 Delikli	329	150	96	6.470,00	1

250 AMPER (A:15 x B:10 mm)

**Yüksek Model**

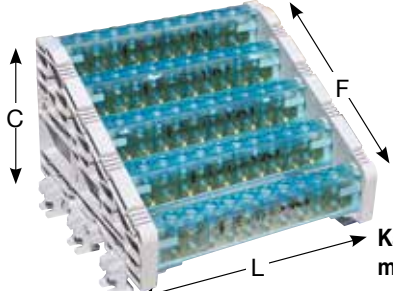

Kablo kesiti  
max. 50 mm<sup>2</sup>

ÜRÜN KODU	ESKİ KOD	CİNSİ	L ± 2	F ± 1	C ± 1	ADET (t)	K. AD.
1080096	ONKA - 2216	2 / 5 - 7 Delikli	143	150	111	2.680,00	1
1080097	ONKA - 2217	2 / 8 - 10 Delikli	180,5	150	111	3.485,00	1
1080098	ONKA - 2218	2 / 10 - 12 Delikli	205	150	111	4.152,00	1
1080099	ONKA - 2219	2 / 13 - 15 Delikli	243	150	111	5.058,00	1
1080100	ONKA - 2220	2 / 20 - 22 Delikli	329	150	111	7.185,00	1

## DAĞITICI ÜNİTE YÜKSELTİCİ AYAKLARI

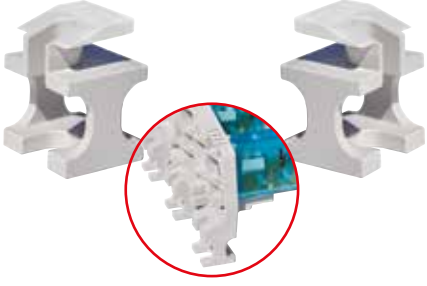

ÜRÜN KODU	ESKİ KOD	CİNSİ	ADET (t)	KUTU ADEDİ
1080135	ONKA-2134	1 - 3 - 5'li dağıtıcı üniteler için yükseltme ayakları	5,70	100

## 5 KADEMELİ 30 x 5 mm BAKIR BARA DAĞITICI ÜNİTELER VE AKSESUARI



ÜRÜN KODU	ESKİ KOD	CİNSİ	ADET (t)	KUTU ADEDİ
1080134	ONKA-2131	5 Katlı Dağıtıcı Ünite (Max. 30x5) Yatak	316,00	10

## FORMLAMA İZOLATÖRÜ

(3/4 Kutuplu - Max. 40x10 mm Bara ile kullanılır.)

**800  
AMPER**

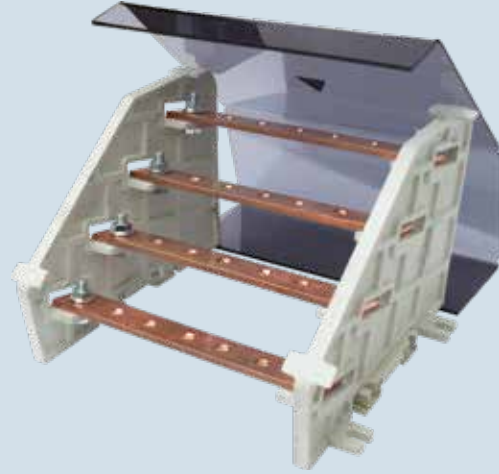

### Notlar:

- ✓ Sağ + Sol ünite kombinasyonu min. 1 takım olarak sevk edilir,
- ✓ 3/4 Kutuplu - Max. 40x10 mm bara ile kullanılır.

- 20 x 5 / 10
- 25 x 5 / 10
- 30 x 5 / 10
- 40 x 5 / 10

Baralar ile esnek dağıtım çözümleri



\* Görseller kullanım şekli amaçlı oluşturulmuştur, ürünümüz sağ ve sol taşıyıcı ikili izolatör takımından ibarettir. Bara ve kapak boyları kullanıcı ihtiyaçlarına göre değişeceğinden ürüne dahil değildir!!

ÜRÜN KODU	CİNSİ	TAKIM (t)
İRTPF-4003	3 Kutuplu Formlama İzolatörü (Max. 40x10)	640,00
İRTPF-4004	4 Kutuplu Formlama İzolatörü (Max. 40x10)	765,00



UL 94 V0  
yanmazlık seviyesi



Ergonomik  
ve kompakt Yapı











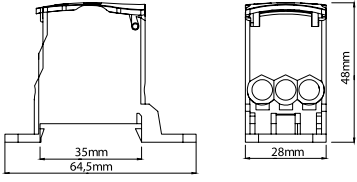
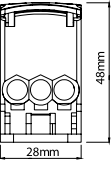

Kısa devre  
dinamiklerine karşı  
max. dayanıklılık

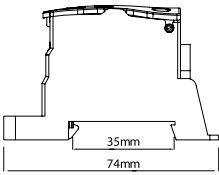
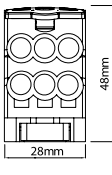

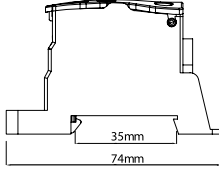
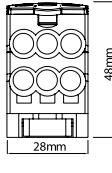
Form1-2-3-4  
seçeneklerinde kolay montaj  
ve işletme çözümü sunar.

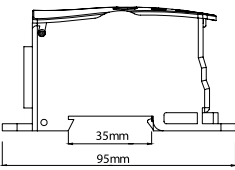
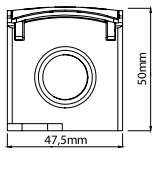
## GÜÇ DAĞITIM BLOKLARI

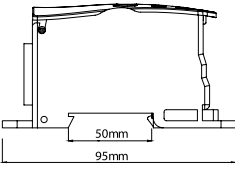
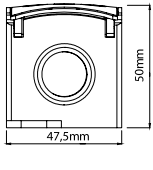

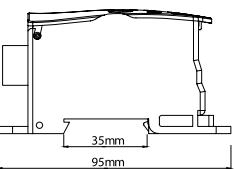
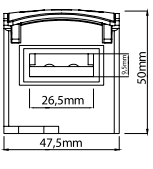
			<b>ÜRÜN KODU</b>	<b>ÇİNSİ</b>	<b>ADET (\$)</b>	<b>KUTU ADEDİ</b>
			<b>ONK80</b>	<b>80 A</b> Giriş: 3 x 6 - 16 mm <sup>2</sup> Çıkış: 4 x 2,5 - 6 mm <sup>2</sup> 3 x 2,5 - 16 mm <sup>2</sup>	<b>4,00 \$</b>	<b>1</b>
			<b>ÜRÜN KODU</b>	<b>ÇİNSİ</b>	<b>ADET (\$)</b>	<b>KUTU ADEDİ</b>
			<b>ONK125</b>	<b>125 A</b> Giriş: 1 x 10 - 35 mm <sup>2</sup> 1 x 2,5 - 16 mm <sup>2</sup> Çıkış: 6 x 2,5 - 16 mm <sup>2</sup>	<b>8,50 \$</b>	<b>1</b>
			<b>ÜRÜN KODU</b>	<b>ÇİNSİ</b>	<b>ADET (\$)</b>	<b>KUTU ADEDİ</b>
			<b>ONK160</b>	<b>160 A</b> Giriş: 1 x 10 - 70 mm <sup>2</sup> 1 x 2,5 - 16 mm <sup>2</sup> Çıkış: 6 x 2,5 - 16 mm <sup>2</sup>	<b>8,60 \$</b>	<b>1</b>
			<b>ÜRÜN KODU</b>	<b>ÇİNSİ</b>	<b>ADET (\$)</b>	<b>KUTU ADEDİ</b>
			<b>ONK250</b>	<b>250 A</b> Giriş: 1 x 35 - 120 mm <sup>2</sup> Çıkış: 2 x 6 - 35 mm <sup>2</sup> 5 x 2,5 - 16 mm <sup>2</sup> 4 x 2,5 - 10 mm <sup>2</sup>	<b>22,50 \$</b>	<b>1</b>
			<b>ÜRÜN KODU</b>	<b>ÇİNSİ</b>	<b>ADET (\$)</b>	<b>KUTU ADEDİ</b>
			<b>ONK400</b>	<b>400 A</b> Giriş: 1 x 95 - 185 mm <sup>2</sup> Çıkış: 2 x 6 - 35 mm <sup>2</sup> 5 x 2,5 - 16 mm <sup>2</sup> 4 x 2,5 - 10 mm <sup>2</sup>	<b>23,50 \$</b>	<b>1</b>
			<b>ÜRÜN KODU</b>	<b>ÇİNSİ</b>	<b>ADET (\$)</b>	<b>KUTU ADEDİ</b>
			<b>ONK500</b>	<b>500 A</b> Bara Giriş: 9,3 x 26,4 mm Çıkış: 2 x 6 - 35 mm <sup>2</sup> 5 x 2,5 - 16 mm <sup>2</sup> 4 x 2,5 - 10 mm <sup>2</sup>	<b>25,00 \$</b>	<b>1</b>



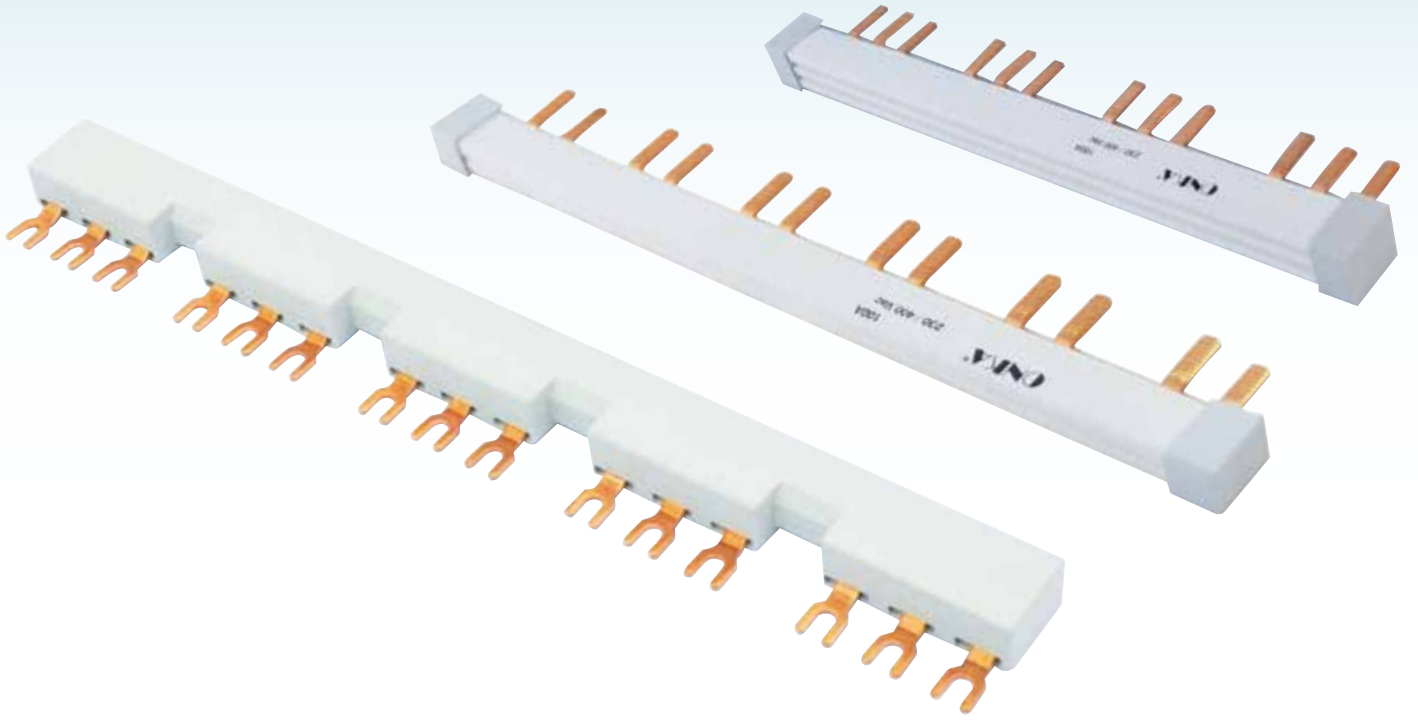

## W OTOMAT BARALARI



## MONOFAZE MÜŞTEREK W OTOMAT BARALARI (İĞNE TİPİ)

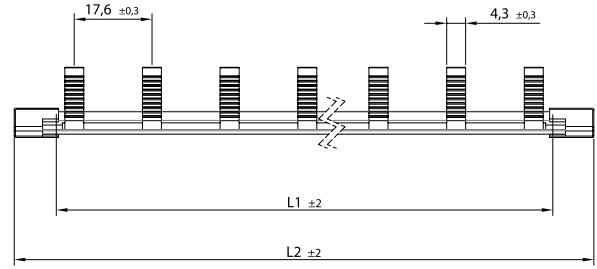

Kod: 3000

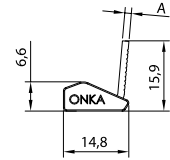

1mm / 80A		1,5mm / 100A		2mm / 125A		MODÜL ADEDİ	KUTU ADEDİ
ÜRÜN KODU	ADET (t)	ÜRÜN KODU	ADET (t)	ÜRÜN KODU	ADET (t)		
ONKA-3006	230,00	ONKA-3001	325,00	ONKA-3011	410,00	12	50
ONKA-3007	347,00	ONKA-3002	485,00	ONKA-3012	620,00	18	50
ONKA-3008	495,00	ONKA-3003	665,00	ONKA-3013	830,00	24	50
ONKA-3009	575,00	ONKA-3004	815,00	ONKA-3014	1.050,00	30	50
ONKA-3010	1.040,00	ONKA-3005	1.485,00	ONKA-3015	1.880,00	56	50
ONKA-3000	Monofaze Bara Yan Kapak				9,50	-	100

## 2 FAZLI MÜŞTEREK W OTOMAT BARALARI (İĞNE TİPİ)

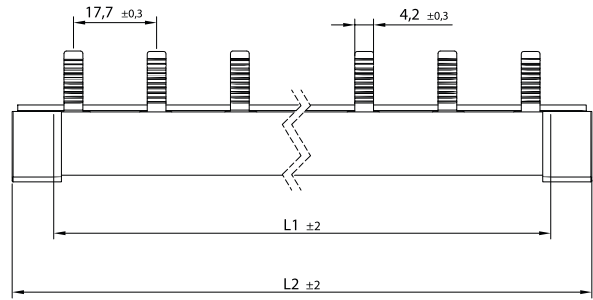

Kod: 3026

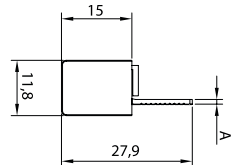

1mm / 80A		1,5mm / 100A		MODÜL ADEDİ	KUTU ADEDİ
ÜRÜN KODU	ADET (t)	ÜRÜN KODU	ADET (t)		
ONKA-3021	460,00	ONKA-3031	655,00	6	30
ONKA-3022	775,00	ONKA-3032	860,00	9	30
ONKA-3023	885,00	ONKA-3033	1.250,00	12	30
ONKA-3024	1.150,00	ONKA-3034	1.560,00	15	30
ONKA-3025	2.050,00	ONKA-3035	2.850,00	28	30
ONKA-3026	İki Fazlı Müşterek W Otomat Barası Yan Kapak		31,20	-	100

## TRİFAZE MÜŞTEREK W OTOMAT BARALARI (İĞNE TİP)



Kod: 5833

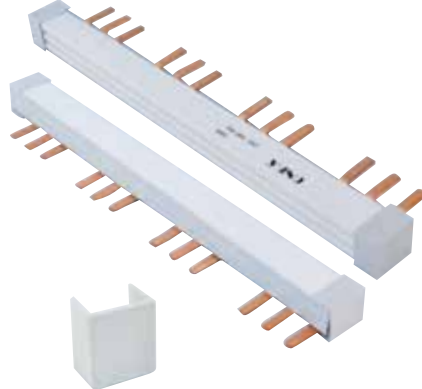

Kod: 3056

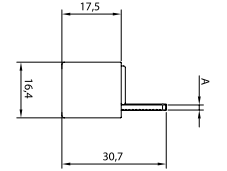
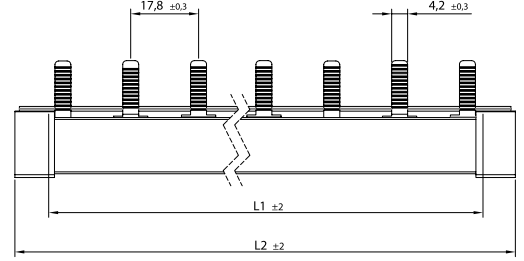

1mm / 80A		1,5mm / 100A		2mm / 125A		MODÜL ADEDİ	KUTU ADEDİ
ÜRÜN KODU	ADET (₺)	ÜRÜN KODU	ADET (₺)	ÜRÜN KODU	ADET (₺)		
ONKA-3041	685,00	ONKA-3051	950,00	ONKA-3066	1.260,00	4	30
ONKA-3042	1.050,00	ONKA-3052	1.450,00	ONKA-3067	1.960,00	6	30
ONKA-3043	1.450,00	ONKA-3053	1.980,00	ONKA-3068	2.540,00	8	30
ONKA-3044	1.700,00	ONKA-3054	2.450,00	ONKA-3069	3.180,00	10	30
ONKA-3045	3.480,00	ONKA-3055	4.680,00	ONKA-3070	6.290,00	20	25
ONKA-5833	1 mm Trifaze Bara Yan Kapak				16,95	-	100
ONKA-3056	1,5 mm Trifaze Bara Yan Kapak				17,35	-	100

## 3 FAZ + NÖTR MÜŞTEREK W OTOMAT BARALARI (İĞNE TİP)

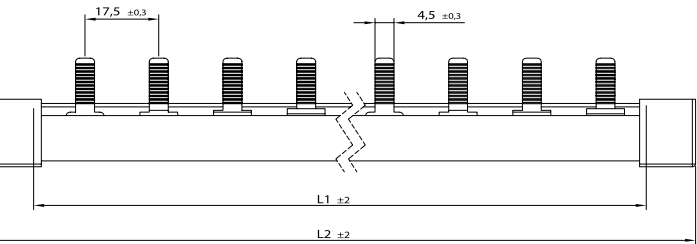
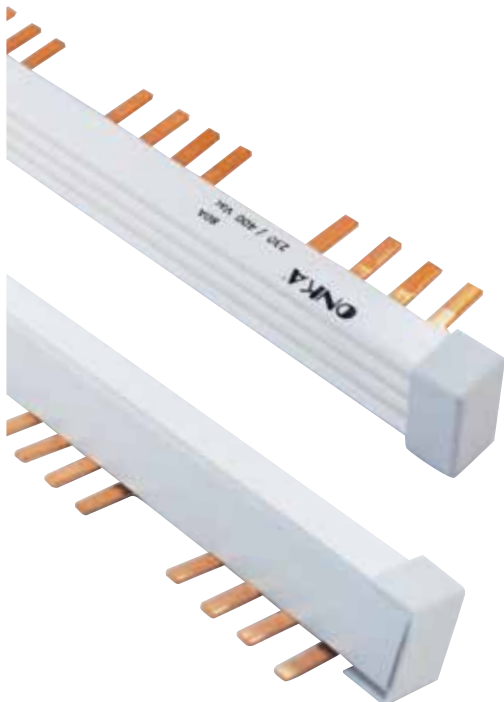

Kod: 3057

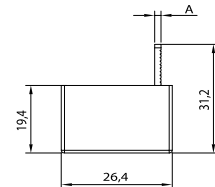

1,5 mm / 100A		TİP	MODÜL ADEDİ	KUTU ADEDİ
ÜRÜN KODU	ADET (₺)			
ONKA-3058	1.920,00	3 Faz + Nötr	4	16
ONKA-3059	3.800,00		8	16
ONKA-3060	6.600,00		14	16
ONKA-3057	16,95	Yan Kapak		100

## İZOLASYONLU MOTOR KORUMA BARALARI (63 A)



ÜRÜN KODU	CİNSİ	ADET (€)	KUTU ADEDİ
ONKA-MSVG54-14-2	Motor Koruma Barası, İkili Modül, Adım Genişliği 45 + 9 = 54 mm	10,52 €	1
ONKA-MSVG54-14-4	Motor Koruma Barası, Dörtlü Modül, Adım Genişliği 45 + 9 = 54 mm	15,58 €	1
ONKA-MSVG54-14-5	Motor Koruma Barası, Beşli Modül, Adım Genişliği 45 + 9 = 54 mm	18,08 €	1
ONKA-MSVG45-14-3	Motor Koruma Barası, Üçlü Modül, Boşluk Yok, Adım Genişliği 45 mm	12,80 €	1
ONKA-MSVG45-14-4	Motor Koruma Barası, Dörtlü Modül, Boşluk Yok, Adım Gen. 45 mm	14,96 €	1

## (L1+N, L2+N, L3+N) MÜŞTEREK W OTOMAT BARA, İĞNE TİP (80 A)

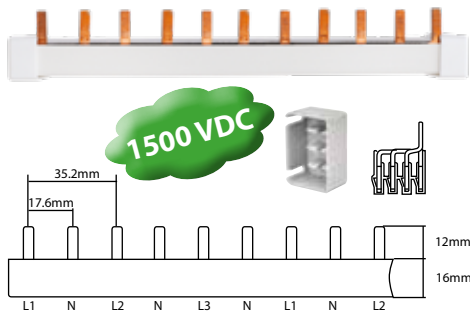

ÜRÜN KODU	CİNSİ	ADET (€)	KUTU ADEDİ
FTG-4S16L54A0A0N-01	L1 + N, L2 + N, L3 + N ... 13 MODÜL 1 mt	94,80 €	1
FTG-A2	Müşterek W Otomat Barası Yan Kapak	0,60 €	1

## MODÜLER GÜÇ KLEMENSLERİ (Monofaze-Difaze-Trifaze Bağlantı Klemensi)

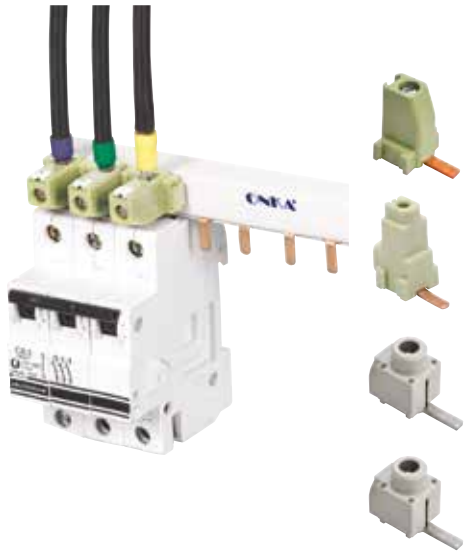

ÜRÜN KODU	ESKİ KOD	CİNSİ	ADET	KUTU ADEDİ
1140013	ONKA-3061	No.1 (2.5 - 10 mm <sup>2</sup> )	39,85 ₺	150
1140014	ONKA-3065	No.2 (16 - 25 mm <sup>2</sup> )	65,95 ₺	100
FTG-802/115 S		No.2 (6 - 25 mm <sup>2</sup> )	2,20 €	30
FTG-802/215 S		No.3 (6 - 50 mm <sup>2</sup> )	2,90 €	25

## GEÇMELİ BAKIR BARA BAĞLANTI KLEMENSLERİ (PALETLİ SİSTEM)

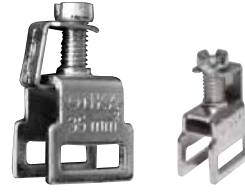

**Bağlantı Kesiti 4 mm<sup>2</sup>**

ÜRÜN KODU	ESKİ KOD	CİNSİ	GERİLİM / AKIM (V/A)	ADET (t)	KUTU ADEDİ
<b>ONKA-2159</b>		12 x 3 mm Bakır Bara için Klemens 4 mm <sup>2</sup> kablo kesiti	690 V / 400 A	<b>20,95</b>	500
<b>1140011</b>	ONKA-2160	12 x 3 mm Bakır Bara için Klemens 16 mm <sup>2</sup> kablo kesiti	690 V / 400 A	<b>22,35</b>	300
<b>1140012</b>	ONKA-2161	12 x 3 mm Bakır Bara için Klemens 35 mm <sup>2</sup> kablo kesiti	690 V / 440 A	<b>26,20</b>	250
<b>ONKA-2162</b>		12 x 3 mm Elektrolitik Bakır Bara 1 mt.		⚡	1 mt.

## (NÖTR) VİDALI TOPRAKLAMA BARALARI



KESİT	1,5 x 15 mm		2 x 15 mm		3 x 15 mm		KUTU ADEDİ
	ÜRÜN KODU	ADET (t)	ÜRÜN KODU	ADET (t)	ÜRÜN KODU	ADET (t)	
<b>31 Vida</b>	<b>ONKA-3075</b>	<b>1.450,00</b>	<b>ONKA-3080</b>	<b>1.750,00</b>	<b>ONKA-3088</b>	<b>2.450,00</b>	25
<b>62 Vida</b>	<b>ONKA-3076</b>	<b>1.850,00</b>	<b>ONKA-3087</b>	<b>2.150,00</b>	<b>ONKA-3086</b>	<b>2.850,00</b>	25

## (NÖTR/TOPRAK) BARA MESNEDİ

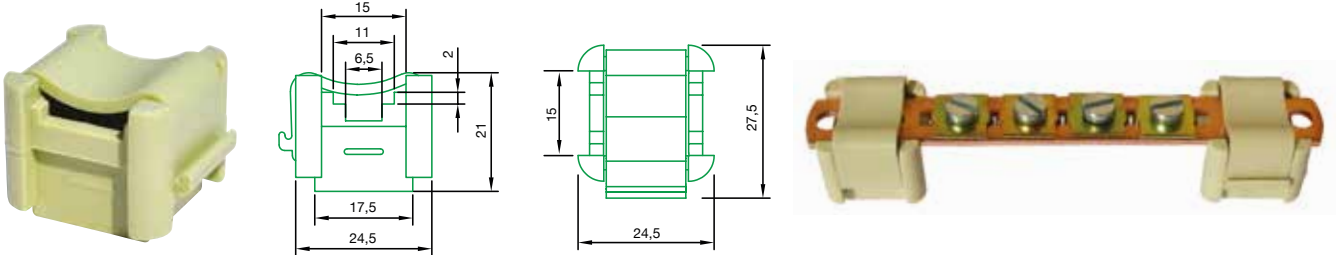

ÜRÜN KODU	ESKİ KOD	CİNSİ	ADET (t)	KUTU ADEDİ
<b>1140015</b>	ONKA-3091	Bara Mesnedi	<b>19,30</b>	100



## BAKIR BARA BAĞLANTI KLEMENSİ (YAY BASKILI) 16 mm<sup>2</sup>

ÜRÜN KODU	ESKİ KOD	CİNSİ	GERİLİM / AKIM (V/A)	ADET (t)	KUTU ADEDİ
1140007	ONKA-2140	SK16 F5 Bakır Bara Klemensi 1,5 - 16 mm <sup>2</sup>	690 V / 180 A	59,00	100
1140008	ONKA-2141	SK16 F10 Bakır Bara Klemensi 1,5 - 16 mm <sup>2</sup>	690 V / 180 A	60,20	100

## BAKIR BARA BAĞLANTI KLEMENSİ (YAY BASKILI) 35 mm<sup>2</sup>

ÜRÜN KODU	ESKİ KOD	CİNSİ	GERİLİM / AKIM (V/A)	ADET (t)	KUTU ADEDİ
1140009	ONKA-2142	SK35 F5 Bakır Bara Klemensi 1,5 - 35 mm <sup>2</sup>	690 V / 270 A	105,10	50
1140010	ONKA-2143	SK35 F10 Bakır Bara Klemensi 1,5 - 35 mm <sup>2</sup>	690 V / 270 A	110,00	50

## BAKIR BARA BAĞLANTI KLEMENSİ (YAY BASKILI) 70 mm<sup>2</sup>

ÜRÜN KODU	CİNSİ	GERİLİM / AKIM (V/A)	ADET (t)	KUTU ADEDİ
ONKA-2144	SK70 F5 Bakır Bara Klemensi, 16 - 70 mm <sup>2</sup>	690 V / 400 A	172,00	10
ONKA-2145	SK70 F10 Bakır Bara Klemensi, 16 - 70 mm <sup>2</sup>	690 V / 400 A	201,50	10

## BAKIR BARA BAĞLANTI KLEMENSİ (YAY BASKILI) 120 mm<sup>2</sup>

ÜRÜN KODU	CİNSİ	GERİLİM / AKIM (V/A)	ADET (t)	KUTU ADEDİ
ONKA-2146	SK120 F5 Bakır Bara Klemensi, 16 - 120 mm <sup>2</sup>	690 V / 440 A	287,50	10
ONKA-2147	SK120 F10 Bakır Bara Klemensi, 16 - 120 mm <sup>2</sup>	690 V / 440 A	305,50	10

### 5 mm Bara için

2140



2142



2144



2146



### 10 mm Bara için

2141



2143



2145



2147



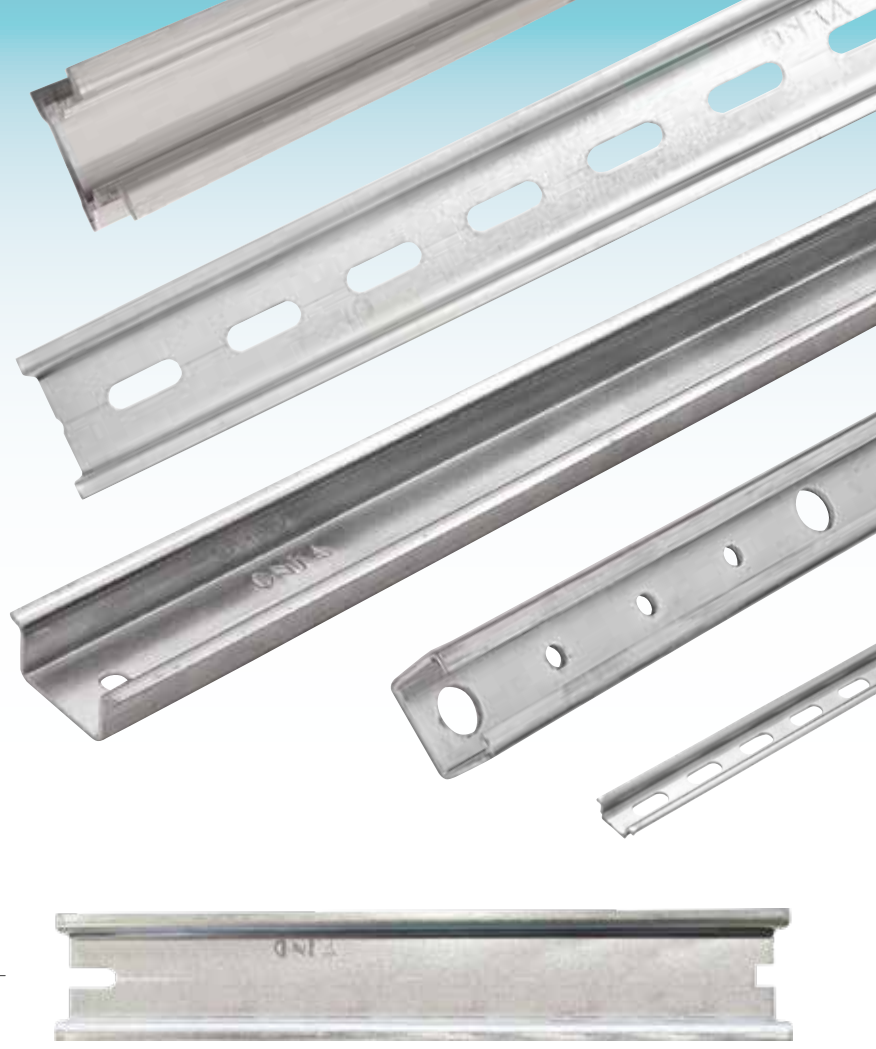
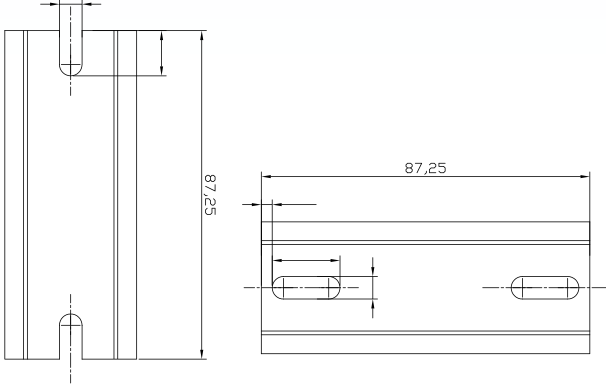

PROJEYE ÖZEL ÜRETİMLER 

## MONTAJ RAYLARI

DIN 46277-3 / TS EN 60715  
Standartlarına Uygundur.

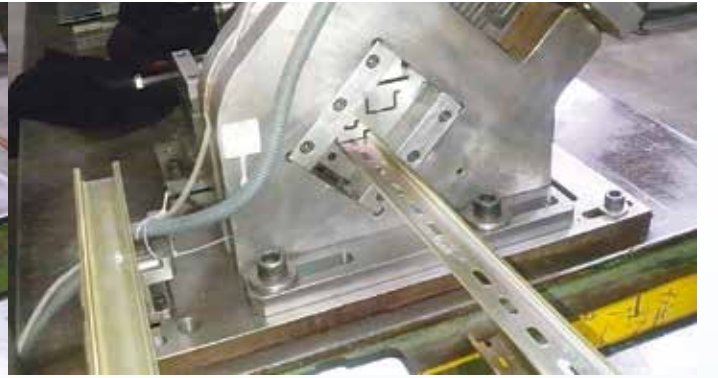
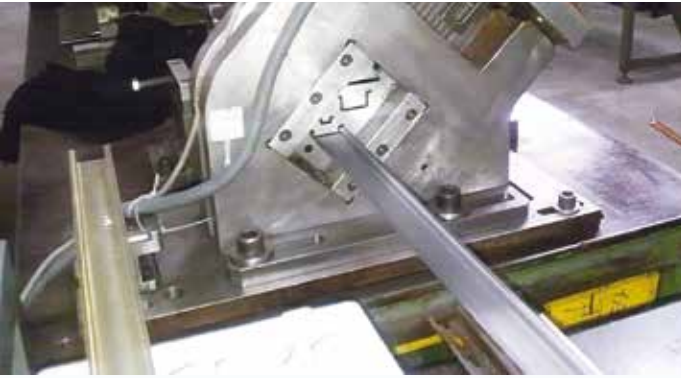

0 FİRE

+

0 KOROZYON

+

0 İŞÇİLİK

=

MALİYET AVANTAJI

İSTENİLEN  
ÖLÇÜDE KESİM  
FİREDEN TASARRUF

KESİMDEN SONRA  
KAPLAMA  
DAHA YÜKSEK KALİTE

ZAMANDAN  
TASARRUF

cm Fiyatı 

## MONTAJ RAYLARI

### 35 x 7,5 DÜZ GALVANİZ KAPLAMALI



**GR** 333 gr/mt.

ÜRÜN KODU	ESKİ KOD	CİNSİ	ADET (t)	KUTU ADEDİ
1100084	ONKA - 4212	1 m	76,20	50
1100085	ONKA - 4213	2 m	151,00	50

### 35 x 7,5 DELİKLİ GALVANİZ KAPLAMALI



**GR** 298 gr/mt.

ÜRÜN KODU	ESKİ KOD	CİNSİ	ADET (t)	KUTU ADEDİ
1100091	ONKA - 4222	1 m	73,60	50
1100092	ONKA - 4223	2 m	146,10	50

### 35 x 7,5 DÜZ CR+3 KAPLAMALI



**GR** 333 gr/mt.

ÜRÜN KODU	ESKİ KOD	CİNSİ	ADET (t)	KUTU ADEDİ
1100012	ONKA - 4022	1 m	89,70	50
1100013	ONKA - 4023	2 m	182,10	50

### 35 x 7,5 DELİKLİ CR+3 KAPLAMALI



**GR** 298 gr/mt.

ÜRÜN KODU	ESKİ KOD	CİNSİ	ADET (t)	KUTU ADEDİ
1100017	ONKA - 4032	1 m	87,10	50
1100018	ONKA - 4033	2 m	177,20	50

### 35 x 7,5 DÜZ ALÜMİNYUM



ÜRÜN KODU	ESKİ KOD	CİNSİ	ADET (t)	KUTU ADEDİ
1100066	ONKA - 4122	1 m	160,60	35
1100067	ONKA - 4123	2 m	324,00	35

### 35 x 7,5 DELİKLİ ALÜMİNYUM



ÜRÜN KODU	ESKİ KOD	CİNSİ	ADET (t)	KUTU ADEDİ
1100071	ONKA - 4132	1 m	169,40	35
1100072	ONKA - 4133	2 m	339,75	35



## MONTAJ RAYLARI

### 35 x 15 DÜZ GALVANİZ KAPLAMALI



**GR** 665 gr/mt.

ÜRÜN KODU	ESKİ KOD	CİNSİ	ADET (t)	KUTU ADEDİ
1100100	ONKA - 4232	1 m	152,75	25
1100101	ONKA - 4233	2 m	297,10	25

### 35 x 15 DELİKLİ GALVANİZ KAPLAMALI



**GR** 595 gr/mt.

ÜRÜN KODU	ESKİ KOD	CİNSİ	ADET (t)	KUTU ADEDİ
1100105	ONKA - 4242	1 m	150,60	25
1100106	ONKA - 4243	2 m	292,35	25

### 35 x 15 DÜZ CR+3 KAPLAMALI



**GR** 665 gr/mt.

ÜRÜN KODU	ESKİ KOD	CİNSİ	ADET (t)	KUTU ADEDİ
1100035	ONKA - 4062	1 m	178,60	25
1100036	ONKA - 4063	2 m	348,70	25

### 35 x 15 DELİKLİ CR+3 KAPLAMALI



**GR** 595 gr/mt.

ÜRÜN KODU	ESKİ KOD	CİNSİ	ADET (t)	KUTU ADEDİ
1100044	ONKA - 4072	1 m	176,45	25
1100041	ONKA - 4073	2 m	344,00	25

### MG TİPİ DÜZ ALÜMİNYUM

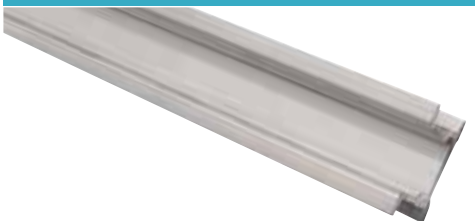

ÜRÜN KODU	ESKİ KOD	CİNSİ	ADET (t)	KUTU ADEDİ
1100076	ONKA - 4142	1 m	268,80	25
1100077	ONKA - 4143	2 m	540,00	25

### MG TİPİ DELİKLİ ALÜMİNYUM



ÜRÜN KODU	ESKİ KOD	CİNSİ	ADET (t)	KUTU ADEDİ
1100080	ONKA - 4147	1 m	277,50	25
1100081	ONKA - 4148	2 m	556,00	25

## MONTAJ RAYLARI

### 15 x 5,5 DÜZ GALVANİZ KAPLAMALI



GR 151 gr/mt.

ÜRÜN KODU	ESKİ KOD	CİNSİ	ADET (t)	KUTU ADEDİ
1100110	ONKA - 4247	1 m	54,10	100
1100111	ONKA - 4248	2 m	95,70	50

### 15 x 5,5 DELİKLİ GALVANİZ KAPLAMALI

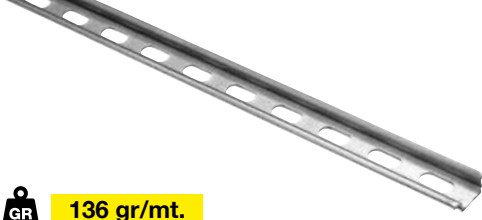

GR 136 gr/mt.

ÜRÜN KODU	ESKİ KOD	CİNSİ	ADET (t)	KUTU ADEDİ
1100115	ONKA - 4252	1 m	52,70	100
1100116	ONKA - 4253	2 m	95,70	50

### 15 x 5,5 DÜZ CR+3 KAPLAMALI



GR 151 gr/mt.

ÜRÜN KODU	ESKİ KOD	CİNSİ	ADET (t)	KUTU ADEDİ
1100055	ONKA - 4102	1 m	60,20	100
1100056	ONKA - 4103	2 m	107,85	50

### 15 x 5,5 DELİKLİ CR+3 KAPLAMALI

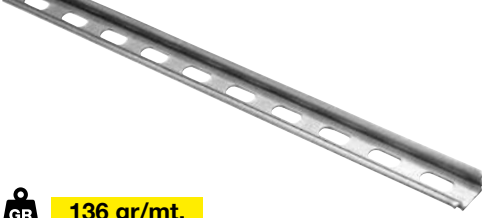

GR 136 gr/mt.

ÜRÜN KODU	ESKİ KOD	CİNSİ	ADET (t)	KUTU ADEDİ
1100060	ONKA - 4112	1 m	58,80	100
1100061	ONKA - 4113	2 m	102,35	50

## U PROFİL DESTEK RAYI (CR+3)



ÜRÜN KODU	ESKİ KOD	CİNSİ	ADET (t)	KUTU ADEDİ
1100120	ONKA-4191	1 Metre U Profil (Cr3)	216,20	35
1100121	ONKA-4192	2 Metre U Profil (Cr3)	428,40	35
1100122	ONKA-4193	3 Metre U Profil (Cr3)	641,60	25
1100124	ONKA-4195	Sağ/Sol Köşe Aparatı	18,80	100

## RAY TAŞIYICI

### SAC CR + 3



33 gr/Ad.

ÜRÜN KODU	ESKİ KOD	CİNSİ	ADET (t)	KUTU ADEDİ
1100119	ONKA - 4172	Ray Taşıyıcı Sac Krom	13,65	100

### ALÜMİNYUM



ÜRÜN KODU	CİNSİ	ADET (t)	KUTU ADEDİ
ONKA - 4161	Ray Taşıyıcı Alüminyum	☎	100

## W OTOMAT RAYI İZOLASYON APARATI



ÜRÜN KODU	ESKİ KOD	CİNSİ	ADET (t)	KUTU ADEDİ
1080136	ONKA-2137	35'lik İzolasyon Aparatı (1 m)	☎	100

## RAY KESME MAKASI



ÜRÜN KODU	CİNSİ	ADET	KUTU ADEDİ
MRK-1	1 çeşit ray (35x7,5) keser ve raya Ø 5,5 mm delik deler.		1
MRK-2	2 çeşit ray (35x7,5 - 35x15) keser ve raya Ø 5,5 mm delik deler.	☎	1
MRK-5	3 çeşit ray (5,5x15-7,5x35-15x35) ve 3x30 mm bakır barayı keser. Raya Ø 5,5 mm delik deler ve Ø 8 mm tij keser.		1



## SIKMALI KABLO PABUÇLARI



EN 61238-1



Civata sökmeden  
kolay montaj imkanı.

## STANDART SKP SIKMALI KABLO PABUÇLARI (BAKIR)

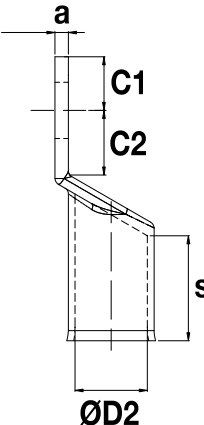
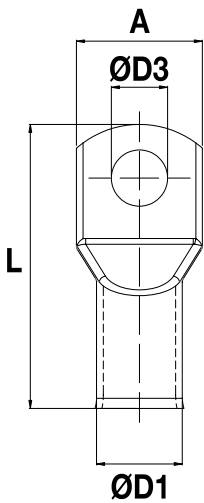

ÜRÜN KODU	KABLO KESİTİ (mm <sup>2</sup> )	CIVATA (Ø)	ØD1 (mm)	ØD2 (mm)	L (mm)	ØD3 (mm)	A (mm)	C1 (mm)	C2 (mm)	a (mm)	s (mm)	GR	ADET (t)	KUTU ADEDİ
ONKA-6250	6	M5	5,5	4	24	5,5	7,9	6	5	1,5	9	2	11,82	1500
ONKA-0232		M6	5,5	4	24	6,5	7,9	6	5	1,5	9			
ONKA-6251	10	M5	6,5	5	24,9	5,3	9,4	5,7	6,3	1,5	9	2,5	15,55	1250
ONKA-0234		M6	6,5	5	24,9	6,5	9,4	5,7	6,3	1,5	9			
ONKA-6252	16	M6	7	5,5	27,7	6,5	10,3	6,4	5,6	1,5	10	3	17,80	750
ONKA-0035		M8	7	5,5	28,3	8,5	12,7	6,4	6,7	1	10			
ONKA-0241	25	M6	9	7,5	34	6,5	13,4	7,5	8,5	1,5	11,5	5	26,73	450
ONKA-6253		M8	9	7,5	34	8,4	13,4	7,5	8,5	1,5	11,5			
ONKA-0245	35	M6	10,5	8,5	39	6,5	15,6	8,7	9,3	2	14	9	44,83	300
ONKA-6254		M8	10,5	8,5	39	8,5	15,6	8,7	9,3	2	14			
ONKA-0246		M10	10,5	8,5	39	10,5	15,6	8,7	9,3	2	14			
ONKA-0249	50	M8	12	10	46,6	8,5	17,8	10,3	11,2	2	17	13	59,10	175
ONKA-6255		M10	12	10	46,6	10,5	17,8	10,3	11,2	2	17			
ONKA-0250		M12	12	10	46,6	13	17,8	10,3	11,2	2	17			
ONKA-0251		M14	12	10	46,6	14,5	17,8	10,3	11,2	2	17			
ONKA-0254	70	M8	14	11,5	49,2	8,5	20,4	10,7	10,8	2,5	17	20	89,64	125
ONKA-6256		M10	14	11,5	49,2	10,5	20,4	10,7	10,8	2,5	17			
ONKA-0255		M12	14	11,5	49,2	13	20,4	10,7	10,8	2,5	17			
ONKA-0256		M14	14	11,5	49,2	14,5	20,4	10,7	10,8	2,5	17			
ONKA-0259	95	M8	16	13,5	53,5	10,5	23,7	10,3	11,7	2,5	21	24	114,70	75
ONKA-6257		M10	16	13,5	53,5	13	23,7	10,3	11,7	2,5	21			
ONKA-0260		M12	16	13,5	53,5	14,5	23,7	10,3	11,7	2,5	21			
ONKA-0261		M14	16	13,5	53,5	17	23,7	10,3	11,7	2,5	21			
ONKA-0267	120	M10	18	15,5	64	10,5	27	13,7	13,3	2,5	24	36	160,05	50
ONKA-6258		M12	18	15,5	64	13	27	13,7	13,3	2,5	24			
ONKA-0268		M14	18	15,5	64	14,5	27	13,7	13,3	2,5	24			
ONKA-0269		M16	18	15,5	64	17	27	13,7	13,3	2,5	24			
ONKA-0274	150	M10	20	16,5	71,2	10,5	29,4	17,4	16,6	3,5	24	59	263,40	40
ONKA-6259		M12	20	16,5	71,2	13	29,4	17,4	16,6	3,5	24			
ONKA-0275		M14	20	16,5	71,2	14,5	29,4	17,4	16,6	3,5	24			
ONKA-0276		M16	20	16,5	71,2	17	29,4	17,4	16,6	3,5	24			
ONKA-0281	185	M10	22	18,5	77	10,5	32,4	17,4	17,6	3,5	27	69	315,90	30
ONKA-0282		M12	22	18,5	77	13	32,4	17,4	17,6	3,5	27			
ONKA-0283		M14	22	18,5	77	14,5	32,4	17,4	17,6	3,5	27			
ONKA-6260		M16	22	18,5	77	17	32,4	17,4	17,6	3,5	27			
ONKA-0285		M20	22	18,5	77	20,5	32,4	17,4	17,6	3,5	27			
ONKA-2756	240	M10	25,5	21,5	83,5	10,5	37,6	17,4	17,6	4	32	107	441,70	25
ONKA-0289		M12	25,5	21,5	83,5	13	37,6	17,4	17,6	4	32			
ONKA-2757		M14	25,5	21,5	83,5	14,5	37,6	17,4	17,6	4	32			
ONKA-6261		M16	25,5	21,5	83,5	17	37,6	17,4	17,6	4	32			
ONKA-0291		M20	25,5	21,5	83,5	20,5	37,6	17,4	17,6	4	32			

## LONG BOY SKP SIKMALI KABLO PABUÇLARI (BAKIR)

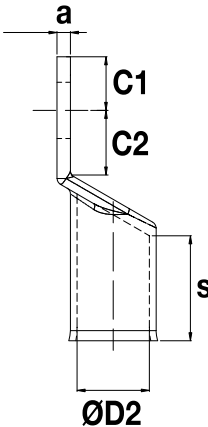
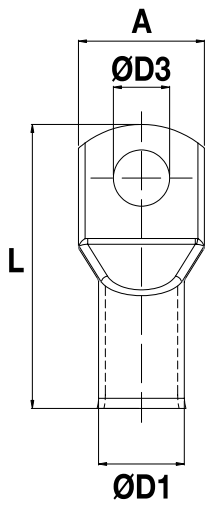

ÜRÜN KODU	KABLO KESİTİ (mm <sup>2</sup> )	CIVATA (Ø)	ØD1 (mm)	ØD2 (mm)	L (mm)	ØD3 (mm)	A (mm)	C1 (mm)	C2 (mm)	a (mm)	s (mm)	GR	ADET (t)	KUTU ADEDİ
ONKA-6025	6	M5	5,5	4	25,7	5,5	7,9	6	5	1,5	11	2	14,36	1500
ONKA-0030		M6	5,5	4	25,7	6,5	7,9	6	5	1,5	11			
ONKA-6026	10	M5	6,5	5	27,3	5,5	11,2	5,6	6,4	1,5	11	2,5	16,08	1000
ONKA-0032		M6	6,5	5	27,3	6,5	11,2	5,6	6,4	1,5	11			
ONKA-6403	16	M6	7	5,5	29,7	6,5	10,3	5,6	6,4	1,5	14	3,5	19,55	600
ONKA-0294		M8	7	5,5	31	8,5	12,7	5,6	6,9	1,1	14			
ONKA-0297	25	M6	9	7,5	40	6,5	13,4	7,3	8,3	1,5	16	6	30,60	300
ONKA-6404		M8	9	7,5	40	8,5	13,4	7,3	8,3	1,5	16			
ONKA-2704	35	M6	10,5	8,5	43,3	6,5	15,6	8,6	9,4	2	19	10	49,20	250
ONKA-6405		M8	10,5	8,5	43,3	8,5	15,6	8,6	9,4	2	19			
ONKA-2705	50	M10	10,5	8,5	43,3	10,5	15,6	8,6	9,4	2	19	15	66,60	150
ONKA-2708		M8	12	10	51,2	8,5	17,8	10,5	11	2	22			
ONKA-6406		M10	12	10	51,2	10,5	17,8	10,5	11	2	22			
ONKA-2709		M12	12	10	51,2	13	17,8	10,5	11	2	22			
ONKA-2710	70	M14	12	10	51,2	14,5	17,8	10,5	11	2	22	23	100,25	100
ONKA-2713		M8	14	11,5	55	8,5	20,4	10,5	11	2,9	24			
ONKA-6407		M10	14	11,5	55	10,5	20,4	10,5	11	2,9	24			
ONKA-2714		M12	14	11,5	55	13	20,4	10,5	11	2,9	24			
ONKA-2715	95	M14	14	11,5	55	14,5	20,4	10,5	11	2,9	24	30	127,70	75
ONKA-2717		M8	16	13,5	59,6	8,5	23,7	10,5	11,5	2,6	27			
ONKA-6408		M10	16	13,5	59,6	10,5	23,7	10,5	11,5	2,6	27			
ONKA-2718		M12	16	13,5	59,6	13	23,7	10,5	11,5	2,6	27			
ONKA-2719	120	M14	16	13,5	59,6	14,5	23,7	10,5	11,5	2,6	27	39	174,05	50
ONKA-2725		M10	18	15,5	70,6	10,5	27	13,6	13,4	2,6	32			
ONKA-6409		M12	18	15,5	70,6	13	27	13,6	13,4	2,6	32			
ONKA-2726		M14	18	15,5	70,6	14,5	27	13,6	13,4	2,6	32			
ONKA-2727	150	M16	18	15,5	70,6	17	27	13,6	13,4	2,6	32	63	276,70	40
ONKA-2732		M10	20	16,5	77,6	10,5	29,4	17,6	16,4	3,4	30			
ONKA-6410		M12	20	16,5	77,6	13	29,4	17,6	16,4	3,4	30			
ONKA-2733		M14	20	16,5	77,6	14,5	29,4	17,6	16,4	3,4	30			
ONKA-2734	185	M16	20	16,5	77,6	17	29,4	17,6	16,4	3,4	30	78	336,15	30
ONKA-2739		M10	22	18,5	85	10,5	32,4	17,6	17,4	3,5	35			
ONKA-2740		M12	22	18,5	85	13	32,4	17,6	17,4	3,5	35			
ONKA-2741		M14	22	18,5	85	14,5	32,4	17,6	17,4	3,5	35			
ONKA-6411	240	M16	22	18,5	85	17	32,4	17,6	17,4	3,5	35	106	465,50	25
ONKA-2743		M20	22	18,5	85	20,5	32,4	17,6	17,4	3,5	35			
ONKA-2747		M10	25,5	21,5	90	10,5	37,6	17,6	17,4	4	40			
ONKA-2748		M12	25,5	21,5	90	13	37,6	17,6	17,4	4	40			
ONKA-2749	240	M14	25,5	21,5	90	14,5	37,6	17,6	17,4	4	40	106	465,50	25
ONKA-6412		M16	25,5	21,5	90	17	37,6	17,6	17,4	4	40			
ONKA-2751	240	M20	25,5	21,5	90	20,5	37,6	17,6	17,4	4	40	106	465,50	25

## EXTRA STANDART SKP SIKMALI KABLO PABUÇLARI (UZUN ve KALIN TİP) (BAKIR)

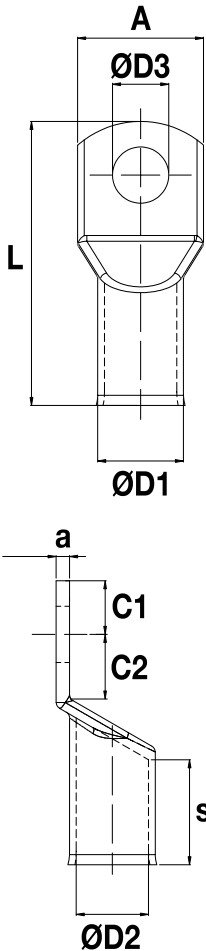

ÜRÜN KODU	KABLO KESİTİ (mm <sup>2</sup> )	CIVATA (Ø)	ØD1 (mm)	ØD2 (mm)	L (mm)	ØD3 (mm)	A (mm)	C1 (mm)	C2 (mm)	a (mm)	s (mm)	GR	ADET (t)	KUTU ADEDİ
ONKA-6025	6	M5	5,5	4	25,7	5,5	7,9	6	5	1,5	11	2	14,36	1500
ONKA-0030		M6	5,5	4	25,7	6,5	7,9	6	5	1,5	11			
ONKA-6026	10	M5	6,5	5	27,3	5,5	9,5	5,6	6,4	1,5	11	3	16,08	1000
ONKA-0032		M6	6,5	5	27,3	6,5	9,5	5,6	6,4	1	11			
ONKA-6027	16	M6	7,8	5,8	29,7	6,5	11,2	5,6	6,4	2	13	4	26,85	600
ONKA-0036		M8	7,8	5,8	33,5	8,5	14	7,8	6,8	1,5	13			
ONKA-0039	25	M6	9,5	7,2	40	6,5	13,5	7,3	8,3	2,3	17	10	44,30	300
ONKA-6028		M8	9,5	7,2	40	8,5	13,5	7,3	8,3	2,3	17			
ONKA-0043	35	M6	10,8	8,5	43,3	6,5	15,7	8,6	9,4	2,3	18	12	63,20	250
ONKA-6029		M8	10,8	8,5	43,3	8,5	15,7	8,6	9,4	2,3	18			
ONKA-0044	50	M10	10,8	8,5	43,3	10,5	15,7	8,6	9,4	2,3	18	21	99,15	150
ONKA-0047		M8	13	10	51,2	8,5	18,7	10,5	11	3	22			
ONKA-6030	70	M10	13	10	51,2	10,5	18,7	10,5	11	3	22	30	132,05	100
ONKA-0048		M12	13	10	51,2	13	18,7	10,5	11	3	22			
ONKA-0049	95	M14	13	10	51,2	14,5	18,7	10,5	11	3	22	37	157,80	75
ONKA-0052		M8	14,7	11,5	55	8,5	21,2	10,5	11	3,2	23			
ONKA-6031	120	M10	14,7	11,5	55	10,5	21,2	10,5	11	3,2	23	52	232,95	50
ONKA-0053		M12	14,7	11,5	55	13	21,2	10,5	11	3,2	23			
ONKA-0054	150	M14	14,7	11,5	55	14,5	21,2	10,5	11	3,2	23	74	318,20	40
ONKA-0057		M8	16,7	13,5	59,6	8,5	24,5	10,5	11,5	3,2	25			
ONKA-6032	185	M10	16,7	13,5	59,6	10,5	24,5	10,5	11,5	3,2	25	92	400,05	30
ONKA-0058		M12	16,7	13,5	59,6	13	24,5	10,5	11,5	3,2	25			
ONKA-0059	240	M14	16,7	13,5	59,6	14,5	24,5	10,5	11,5	3,2	25	133	587,50	25
ONKA-0065		M10	19	15,6	70,6	10,5	28	13,6	13,4	3,4	32			
ONKA-6033	300	M12	19	15,6	70,6	13	28	13,6	13,4	3,4	32	181	874,90	10
ONKA-0066		M14	19	15,6	70,6	14,5	28	13,6	13,4	3,4	32			
ONKA-0067	400	M16	19	15,6	70,6	17	28	13,6	13,4	3,4	32	282	1.240,00	10
ONKA-0072		M10	21	17	77,6	10,5	30,6	17,6	16,4	4	32			
ONKA-6034	400	M12	21	17	77,6	13	30,6	17,6	16,4	4	32	282	1.240,00	10
ONKA-0073		M14	21	17	77,6	14,5	30,6	17,6	16,4	4	32			
ONKA-0074	400	M16	21	17	77,6	17	30,6	17,6	16,4	4	32	282	1.240,00	10
ONKA-0079		M10	23	19	85	10,5	34	17,6	17,4	4	35			
ONKA-0080	400	M12	23	19	85	13	34	17,6	17,4	4	35	282	1.240,00	10
ONKA-0081		M14	23	19	85	14,5	34	17,6	17,4	4	35			
ONKA-6035	400	M16	23	19	85	17	34	17,6	17,4	4	35	282	1.240,00	10
ONKA-0083		M20	23	19	85	20,5	34	17,6	17,4	4	35			
ONKA-0087	400	M10	26	21	90	10,5	37,8	17,6	17,4	5	35	282	1.240,00	10
ONKA-0088		M12	26	21	90	13	37,8	17,6	17,4	5	35			
ONKA-0089	400	M14	26	21	90	14,5	37,8	17,6	17,4	5	35	282	1.240,00	10
ONKA-6036		M16	26	21	90	17	37,8	17,6	17,4	5	35			
ONKA-0091	400	M20	26	21	90	20,5	37,8	17,6	17,4	5	35	282	1.240,00	10
ONKA-0094		M14	29	23,5	103	14,5	42	21,2	14,8	5,1	35			
ONKA-6037	400	M16	29	23,5	103	17	42	21,2	14,8	5,1	35	282	1.240,00	10
ONKA-0096		M20	29	23,5	103	20,5	42	21,2	14,8	5,1	35			
ONKA-0099	400	M14	32,8	27	125	14,5	47,5	24	16	5,8	36	282	1.240,00	10
ONKA-0100		M16	32,8	27	125	17	47,5	24	16	5,8	36			
ONKA-6038	400	M20	32,8	27	125	20,5	47,5	24	16	5,8	36	282	1.240,00	10

## DIN NORMU 46235 TİP SKP SIKMALI KABLO PABUÇLARI (BAKIR)

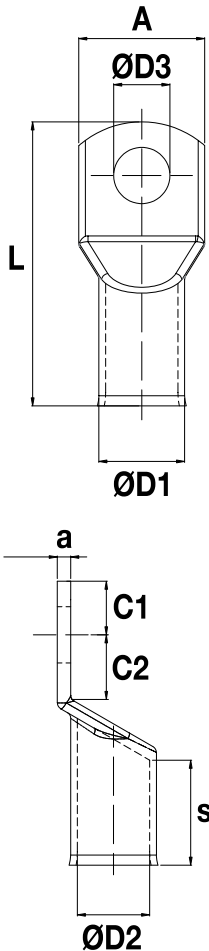

ÜRÜN KODU	KABLO KESİTİ (mm <sup>2</sup> )	CIVATA (Ø)	ØD1 (mm)	ØD2 (mm)	L (mm)	ØD3 (mm)	A (mm)	C1 (mm)	C2 (mm)	a (mm)	s (mm)	GR	ADET (t)	KUTU ADEDİ
ONKA-6052	10	M5	6,5	5	34	5,5	9,5	7	8,5	1,5	13	3	19,00	800
ONKA-6053		M6	6,5	5	34	6,5	9,5	7	8,5	1,5	13			
ONKA-6054	16	M6	8,5	5,5	46	6,5	13	10	8	2	21	11	54,70	275
ONKA-6055		M8	8,5	5,5	46	8,5	13	10	10	2	21			
ONKA-6056	25	M10	8,5	5,5	46	10,5	13	10	12	2	21	13	66,60	250
ONKA-6057		M6	10	7	48	6,5	16	10	8	3	21			
ONKA-6058		M8	10	7	48	8,5	16	10	10	3	21			
ONKA-6059	35	M10	10	7	48	10,5	16	10	12	3	21	29	131,00	150
ONKA-6106		M12	10	7	48	13	16	10	13	3	21			
ONKA-6061		M8	12,5	8,2	54	8,5	19	12	10	4,3	22			
ONKA-6062	50	M10	12,5	8,2	54	10,5	19	12	12	4,3	22	44	193,50	75
ONKA-6063		M12	12,5	8,2	54	13	19	12	13	4,3	22			
ONKA-6064		M8	14,5	10	64	8,5	21,5	12	10	4,5	31			
ONKA-6065	70	M10	14,5	10	64	10,5	21,5	12	12	4,5	31	62	248,30	50
ONKA-6066		M12	14,5	10	64	13	21,5	12	13	4,5	31			
ONKA-6067		M16	14,5	10	64	17	21,5	12	16	4,5	31			
ONKA-6068	95	M8	16,5	11,5	68	8,5	23,8	13	10	5	32	90	372,00	40
ONKA-6069		M10	16,5	11,5	68	10,5	23,8	13	12	5	32			
ONKA-6070		M12	16,5	11,5	68	13	23,8	13	13	5	32			
ONKA-6072	120	M16	16,5	11,5	68	17	23,8	13	16	5	32	112	467,80	30
ONKA-6074		M10	19	13,5	78,5	10,5	27	14	12	5,5	40			
ONKA-6075		M12	19	13,5	78,5	13	27	14	14	5,5	40			
ONKA-6077	150	M16	19	13,5	78,5	17	27	14	16	5,5	40	160	691,60	25
ONKA-6078		M10	21	15,5	86	10,5	30	16,5	16	5,5	40			
ONKA-6079		M12	21	15,5	86	13	30	16,5	16,5	5,5	40			
ONKA-6081	185	M16	21	15,5	86	17	30	16,5	20	5,5	40	188	812,00	20
ONKA-6082		M20	21	15,5	86	20,5	30	16,5	22	5,5	40			
ONKA-6083		M10	23,5	17	94	10,5	34	16	16	6,5	40			
ONKA-6084	240	M12	23,5	17	94	13	34	16	17	6,5	40	223	1.123,00	15
ONKA-6086		M16	23,5	17	94	17	34	16	20	6,5	40			
ONKA-6087		M20	23,5	17	94	20,5	34	16	22	6,5	40			
ONKA-6088	300	M10	25,5	19	98	10,5	37	16	16	6,5	40	-	1.316,00	10
ONKA-6089		M12	25,5	19	98	13	37	16	17	6,5	40			
ONKA-6091		M16	25,5	19	98	17	37	16	20	6,5	40			
ONKA-6092	400	M20	25,5	19	98	20,5	37	16	22	6,5	40	-	1.764,49	5
ONKA-6094		M12	29	21,5	108	13	42	16	17	7,5	55			
ONKA-6096		M16	29	21,5	108	17	42	16	20	7,5	55			
ONKA-6097	400	M20	29	21,5	108	20,5	42	16	22	7,5	55	-	1.764,49	5
ONKA-6098		M14	32	24,5	119	14,5	48	19	22	7,5	55			
ONKA-6099		M16	32	24,5	119	17	48	19	22	7,5	55			
ONKA-6100	400	M20	32	24,5	119	20,5	48	19	22	7,5	55	-	1.764,49	5
ONKA-6101		M14	38,5	27,5	140	14,5	55	19	22	11	60			
ONKA-6102		M16	38,5	27,5	140	17	55	19	22	11	60			
ONKA-6103	400	M20	38,5	27,5	140	20,5	55	19	22	11	60	-	1.764,49	5
ONKA-6103		M20	38,5	27,5	140	20,5	55	19	22	11	60			



## 45° SIKMALI KABLO PABUÇLARI

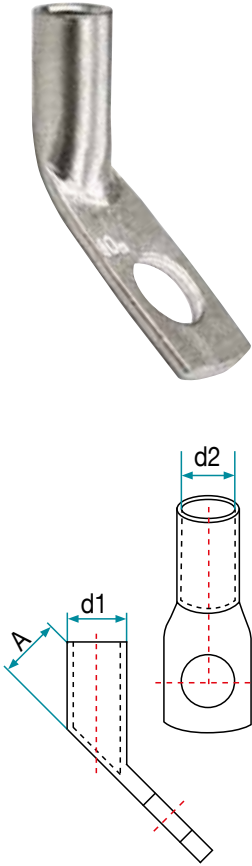

ÜRÜN KODU	KABLO KESİTİ (mm <sup>2</sup> )	CIVATA (Ø)	İÇ ÇAP (d1) (mm)	DIŞ ÇAP (d2) (mm)	KABLO BOYU (A)	ADET (t)	KUTU ADEDİ
ONKA-6306	16	M 6/8/10	5.50	7.50	12.50	Ⓢ	300
ONKA-6307	25	M 8/10	7.00	9.50	15.50		200
ONKA-6308	35	M 8/10	8.50	11.00	17.00		125
ONKA-6309	50	M 10/12	10.00	13.00	18.50		80
ONKA-6310	70	M 10/12	11.50	14.50	22.00		60
ONKA-6311	95	M 10/12/14	13.50	16.50	24.00		40
ONKA-6312	120	M 10/12/14	14.50	18.00	27.00		30
ONKA-6313	150	M 10/12/16	16.50	21.00	29.00		25
ONKA-6314	185	M 10/12/16	18.50	23.00	32.00		20
ONKA-6315	240	M 10/12/16	21.00	26.00	37.00		15
ONKA-6316	300	M 12/16	23.50	28.50	39.00		8

## 90° SIKMALI KABLO PABUÇLARI

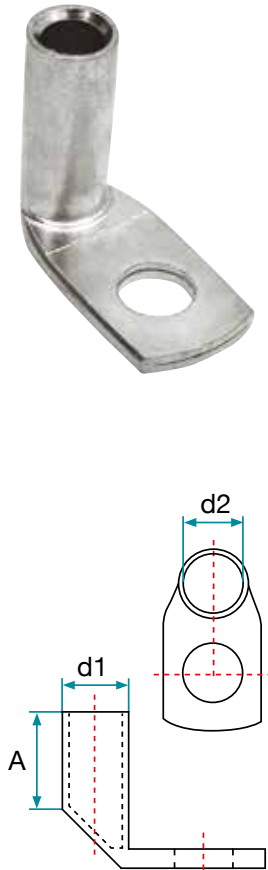

ÜRÜN KODU	KABLO KESİTİ (mm <sup>2</sup> )	CIVATA (Ø)	İÇ ÇAP (d1) (mm)	DIŞ ÇAP (d2) (mm)	KABLO BOYU (A)	ADET (t)	KUTU ADEDİ
ONKA-6321	16	M 6/8/10	5.50	7.50	12.50	Ⓢ	300
ONKA-6322	25	M 8/10	7.00	9.50	15.50		200
ONKA-6323	35	M 8/10	8.50	11.00	17.00		150
ONKA-6324	50	M 10/12	10.00	13.00	18.50		80
ONKA-6325	70	M 10/12	11.50	14.50	22.00		60
ONKA-6326	95	M 10/12/14	13.50	16.50	24.00		50
ONKA-6327	120	M 10/12/14	14.50	18.00	27.00		30
ONKA-6328	150	M 10/12/16	16.50	21.00	29.00		25
ONKA-6329	185	M 10/12/16	18.50	23.00	32.00		20
ONKA-6330	240	M 10/12/16	21.00	26.00	37.00		15
ONKA-6331	300	M 12/16	23.50	28.50	39.00		8

## ÇATAL TİP SIKMALI KABLO PABUÇLARI

Cıvataları tam sökmeden kolay montaj

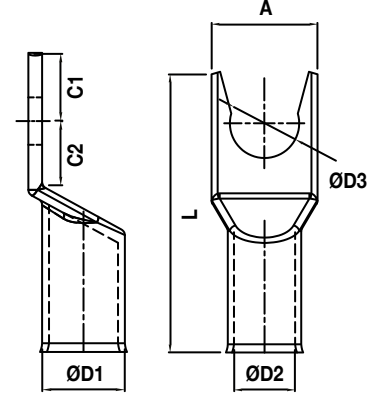

ÜRÜN KODU	KABLO KESİTİ (mm <sup>2</sup> )	CIVATA (Ø)	ØD1 (mm)	ØD2 (mm)	L (mm)	ØD3 (mm)	A (mm)	C1 (mm)	C2 (mm)	ADET (♣)	KUTU ADEDİ
ONKA-6210	10	M5	6,5	5	25	5,5	9,5	5,5	6,5	18,15	1250
ONKA-6211	16	M6	7	5,5	27,5	6,5	10,5	5,5	6,5	20,55	750
ONKA-6212	25	M8	9	7,5	34	8,5	13	7	9	29,20	450
ONKA-6213	35	M8	10,5	8,5	39	8,5	15,5	8,5	9,5	47,15	300
ONKA-6214	50	M8	12	10	47	8,5	18	10	11,5	61,00	175

## ALÜMİNYUM DIN NORMU SKP SIKMALI KABLO PABUÇLARI

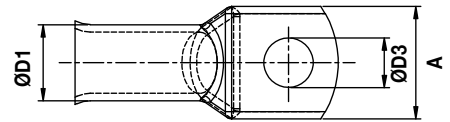
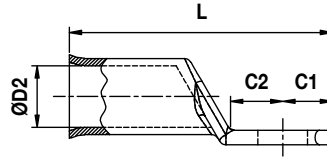

ÜRÜN KODU	KABLO KESİTİ (mm <sup>2</sup> )	CIVATA (Ø)	ØD1 (mm)	ØD2 (mm)	L (mm)	ØD3 (mm)	A (mm)	C1 (mm)	C2 (mm)	ADET (♣)	KUTU ADEDİ
ONKA-6122	10	M5	8	5	50	5,5	9	7	8,5	18,30	300
ONKA-6123	16	M8	10	6	53	8,4	13,7	10	10	21,45	200
ONKA-6124	25	M8	12	7	62	8,4	16	10	10	25,50	100
ONKA-6125	35	M10	14	8,2	70	10,5	19	12	12	31,10	75
ONKA-6126	50	M10	16	10	80	10,5	22	12	12	36,90	50
ONKA-6127	70	M10	18	12	90	10,5	24	12	12	44,00	40
ONKA-6128	95	M12	22	13,4	95	13	28	13	13	69,20	25
ONKA-6129	120	M12	23	15	110	13	32	16	17	86,50	20
ONKA-6130	150	M12	26	16,5	114	13	34	16	17	101,60	15
ONKA-6131	185	M12	28	18,5	125	13	37	16	17	118,35	10
ONKA-6132	240	M12	32	20	140	13	42	16	17	156,20	8

## KAYNAKLI TİP SKP

DIN 46234 Standartı,  
Bakır Malzemeden  
Kalay Kaplı



ÜRÜN KODU	KABLO KESİTİ (mm <sup>2</sup> )	CIVATA (Ø)	Ød1 (mm)	l <sub>1</sub> (mm)	b (mm)	l <sub>2</sub> (mm)	d2 (mm)	ADET (\$)	KUTU ADEDİ
ONKA-102012	1.5 - 2.5	M3	2.3	10.8	6.0	4.8	3.2	0,095	1000
ONKA-102016		M4	2.3	11.8	8.0	4.8	4.3	0,108	1000
ONKA-102018		M5	2.3	13.8	10.0	4.8	5.3	0,135	1000
ONKA-102020		M6	2.3	15.8	11.0	4.8	6.5	0,162	1000
ONKA-102022		M8	2.3	16.8	14.0	4.8	8.4	0,189	1000
ONKA-102023		M10	2.3	17.0	15.0	4.8	10.5	0,257	1000
ONKA-102024	4 - 6	M4	3.6	14.0	8.0	6.0	4.3	0,216	100
ONKA-102026		M5	3.6	15.0	10.0	6.0	5.3	0,216	100
ONKA-102028		M6	3.6	16.0	11.0	6.0	6.5	0,216	100
ONKA-102030		M8	3.6	19.0	14.0	6.0	8.4	0,284	100
ONKA-102032		M10	3.6	21.0	18.0	6.0	10.5	0,338	100
ONKA-102033	M12	3.6	21.0	18.0	6.0	13.0	0,351	100	
ONKA-102036	10	M5	4.5	16.0	10.0	8.0	5.3	0,338	100
ONKA-102038		M6	4.5	17.0	11.0	8.0	6.5	0,351	100
ONKA-102040		M8	4.5	20.0	14.0	8.0	8.4	0,405	100
ONKA-102042		M10	4.5	21.0	18.0	8.0	10.5	0,473	100
ONKA-102044	M12	4.5	23.0	22.0	8.0	13.0	0,581	100	
ONKA-102046	16	M5	5.8	20.0	11.0	10.0	5.3	0,527	100
ONKA-102048		M6	5.8	20.0	11.0	10.0	6.5	0,540	100
ONKA-102050		M8	5.8	22.0	14.0	10.0	8.4	0,567	100
ONKA-102052		M10	5.8	24.0	18.0	10.0	10.5	0,648	100
ONKA-102054		M12	5.8	26.0	22.0	10.0	13.0	0,689	100
ONKA-102056		M5	7.5	25.0	12.0	11.0	5.3	0,810	100
ONKA-102058	M6	7.5	25.0	12.0	11.0	6.5	0,810	100	
ONKA-102060	25	M8	7.5	25.0	16.0	11.0	8.4	0,865	100
ONKA-102062		M10	7.5	26.0	18.0	11.0	10.5	0,972	100
ONKA-102064		M12	7.5	31.0	22.0	11.0	13.0	1,148	100
ONKA-102068		M16	7.5	35.0	28.0	11.0	17.0	1,299	100
ONKA-102070	35	M6	9.0	26.0	15.0	12.0	6.5	1,193	100
ONKA-102072		M8	9.0	26.0	16.0	12.0	8.4	1,296	100
ONKA-102074		M10	9.0	27.0	18.0	12.0	10.5	1,296	100
ONKA-102076		M12	9.0	31.0	22.0	12.0	13.0	1,458	100
ONKA-102080	50	M16	9.0	35.0	28.0	12.0	17.0	1,769	100
ONKA-102082		M6	11.0	34.0	18.0	16.0	6.5	2,106	100
ONKA-102084		M8	11.0	34.0	18.0	16.0	8.4	2,106	100
ONKA-102086		M10	11.0	34.0	18.0	16.0	10.5	2,106	100
ONKA-102088		M12	11.0	36.0	22.0	16.0	13.0	2,282	100
ONKA-102092	M16	11.0	40.0	22.0	16.0	17.0	3,105	100	
ONKA-102093	70	M6	15.0	38.0	22.0	18.0	6.5	2,927	100
ONKA-102094		M8	15.0	38.0	22.0	18.0	8.4	2,927	100
ONKA-102096		M10	15.0	38.0	22.0	18.0	10.5	3,078	100
ONKA-102102		M16	15.0	42.0	28.0	18.0	17.0	3,308	100
ONKA-102103	95	M8	15.0	42.0	24.0	20.0	8.4	4,401	100
ONKA-102104		M10	15.0	42.0	24.0	20.0	10.5	4,401	100
ONKA-102106		M12	15.0	42.0	24.0	20.0	13.0	4,401	100
ONKA-102110		M16	15.0	44.0	28.0	20.0	17.0	4,550	100
ONKA-102111	120	M8	16.5	44.0	24.0	22.0	8.4	6,496	50
ONKA-102112		M10	16.5	44.0	24.0	22.0	10.5	6,496	50
ONKA-102114		M12	16.5	44.0	24.0	22.0	13.0	6,496	50
ONKA-102118		M16	16.5	48.0	28.0	22.0	17.0	6,818	50
ONKA-102120	150	M10	19.0	50.0	30.0	24.0	10.5	11,273	50
ONKA-102123		M12	19.0	50.0	30.0	24.0	13.0	11,273	50
ONKA-102126		M16	19.0	50.0	30.0	24.0	17.0	11,273	50
ONKA-102128	185	M12	21.0	50.0	36.0	28.0	13.0	17,298	50
ONKA-102132		M16	21.0	50.0	36.0	28.0	17.0	17,298	50
ONKA-102134	240	M12	23.5	56.0	38.0	32.0	13.0	21,638	50
ONKA-102138		M16	23.5	56.0	38.0	32.0	17.0	21,638	50

## STANDART SIKMALI EK MUFLAR (BAKIR)

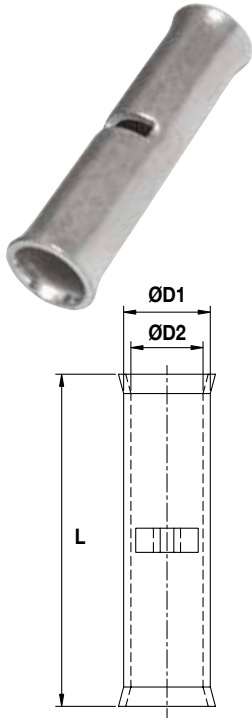

ÜRÜN KODU	KABLO KESİTİ (mm <sup>2</sup> )	ØD1 (mm)	ØD2 (mm)	L (mm)	ADET (t)	KUTU ADEDİ
ONKA - 6141	10	6.5	5	25.5	18,35	750
ONKA - 6142	16	7	5.5	28	20,80	500
ONKA - 6143	25	9	7.5	34.5	30,45	300
ONKA - 6144	35	10.5	8.5	39.5	51,45	200
ONKA - 6145	50	12	10	47.5	65,30	150
ONKA - 6146	70	14	11.5	49.5	100,15	100
ONKA - 6147	95	16	13.5	53.5	122,95	75
ONKA - 6148	120	18	15.5	64	170,25	50
ONKA - 6149	150	20	16.5	70	280,95	35
ONKA - 6150	185	22	18.5	75	329,50	25
ONKA - 6151	240	25.5	21.5	83.5	478,65	15

## EKSTRA STANDART UZUN ve KALIN TİP SIKMALI EK MUFLAR (BAKIR)

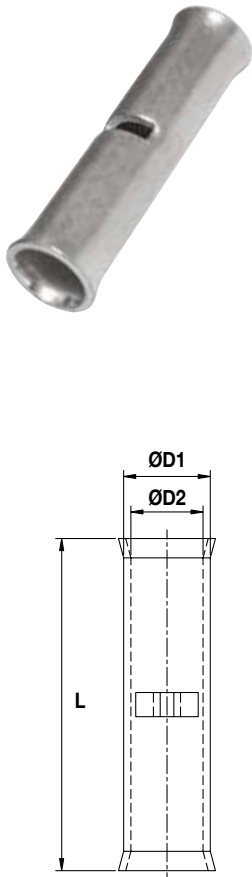

ÜRÜN KODU	KABLO KESİTİ (mm <sup>2</sup> )	ØD1 (mm)	ØD2 (mm)	L (mm)	ADET (t)	KUTU ADEDİ
ONKA - 6160	6	5.5	4	26.5	16,90	1000
ONKA - 6161	10	6.5	5	28	18,85	750
ONKA - 6162	16	7.8	5.8	30.5	21,20	500
ONKA - 6163	25	9.5	7.2	40.5	48,80	400
ONKA - 6164	35	10.8	8.5	44	68,00	250
ONKA - 6165	50	13	10	50	108,90	150
ONKA - 6166	70	14.7	11.5	55.5	142,50	100
ONKA - 6167	95	16.7	13.5	59.5	168,05	75
ONKA - 6168	120	19	15.6	65	247,95	50
ONKA - 6169	150	21	17	70	343,30	35
ONKA - 6170	185	23	19	75	435,60	25
ONKA - 6171	240	26	21	85	632,70	20
ONKA - 6172	300	28.6	23.5	100	904,90	12
ONKA - 6173	400	32.8	27	110	1.278,00	10
ONKA - 6174	500	-	-	-	Ⓢ	10
ONKA - 6175	625	-	-	-	Ⓢ	10

## DIN NORMU 46235 TİP SIKMALI EK MUFLAR (BAKIR)

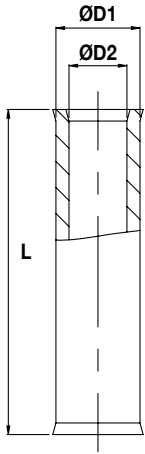

ÜRÜN KODU	KABLO KESİTİ (mm <sup>2</sup> )	ØD1 (mm)	ØD2 (mm)	L (mm)	ADET (t)	KUTU ADEDİ
ONKA - 6181	10	6,5	5,0	30	19,20	400
ONKA - 6182	16	8,5	5,5	50	63,75	250
ONKA - 6183	25	10,0	7,0	50	74,05	125
ONKA - 6184	35	12,5	8,2	50	130,55	100
ONKA - 6185	50	14,5	10,0	56	181,40	100
ONKA - 6186	70	16,5	11,5	56	220,80	50
ONKA - 6187	95	19,0	13,5	70	346,70	40
ONKA - 6188	120	21,0	15,5	70	382,10	30
ONKA - 6189	150	23,5	17,0	80	572,95	20
ONKA - 6190	185	25,5	19,0	85	682,85	10
ONKA - 6191	240	29,0	21,5	90	952,50	10
ONKA - 6192	300	32	24,5	100	⊗	10
ONKA - 6193	400	38,5	27,5	150	⊗	10
ONKA - 6194	500	-	-	-	⊗	10
ONKA - 6195	625	-	-	-	⊗	10

## ALÜMİNYUM DIN NORMU SIKMALI EK MUFLAR

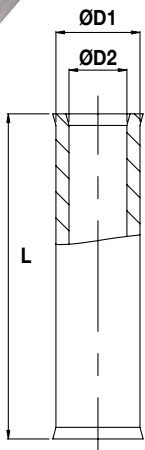

ÜRÜN KODU	KABLO KESİTİ (mm <sup>2</sup> )	ØD1 (mm)	ØD2 (mm)	L (mm)	ADET (t)	KUTU ADEDİ
ONKA - 6270	10	8	5	52	12,85	300
ONKA - 6271	16	10	6	55	15,20	250
ONKA - 6272	25	12	7	64	19,55	150
ONKA - 6273	35	14	8,2	72	25,35	75
ONKA - 6274	50	16	10	82	33,05	50
ONKA - 6275	70	18	12	92	39,50	35
ONKA - 6276	95	22	13,4	97	63,90	20
ONKA - 6277	120	23	15	112	75,35	15
ONKA - 6278	150	26	16,5	116	103,95	8
ONKA - 6279	185	28	18,5	127	118,90	7
ONKA - 6280	240	32	20	142	178,35	5



**YÜKSEK SAFLIKTA  
BAKIRDAN DÖVME TEKNİĞİ  
İLE ÜRETİLMİŞTİR.**

## BİMETAL (Cu/Al) BAĞLANTI APARATLARI



## BAKIR ALÜMİNYUMLU SKP (Bimetal)

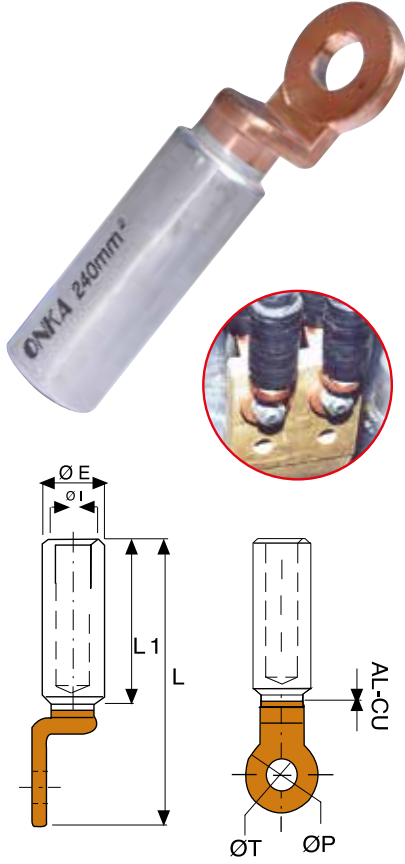

ÜRÜN KODU	KABLO KESİTİ (mm <sup>2</sup> )	ØE (mm)	Ø1 (mm)	L (mm)	ØT (mm)	L1 (mm)	ADET (\$)	KUTU ADEDİ
ONKA-6108	16	20	6,5	84	12,8	46	3,20 \$	80
ONKA-6109	25	20	6,5	84	12,8	46	3,20 \$	80
ONKA-6110	35	20	8	84	12,8	46	3,20 \$	80
ONKA-6111	50	20	9	84	12,8	46	4,20 \$	60
ONKA-6112	70	20	11	84	12,8	46	4,20 \$	60
ONKA-6113	95	20	12,5	84	12,8	46	4,20 \$	60
ONKA-6114	120	25	13,7	107	12,8	62,5	6,50 \$	30
ONKA-6115	150	25	15,5	107	12,8	62,5	6,50 \$	30
ONKA-6116	185	32	17	117	14,5	64	10,70 \$	15
ONKA-6117	240	32	19,5	117	14,5	64	10,70 \$	15
ONKA-6118	300	36	23,3	157	16,3	90	17,50 \$	9
ONKA-6119	400	36	26	157	16,3	90	17,50 \$	9

## BAKIR ALÜMİNYUMLU SKP (Bimetal Dar Kafa Şalter Tipi)

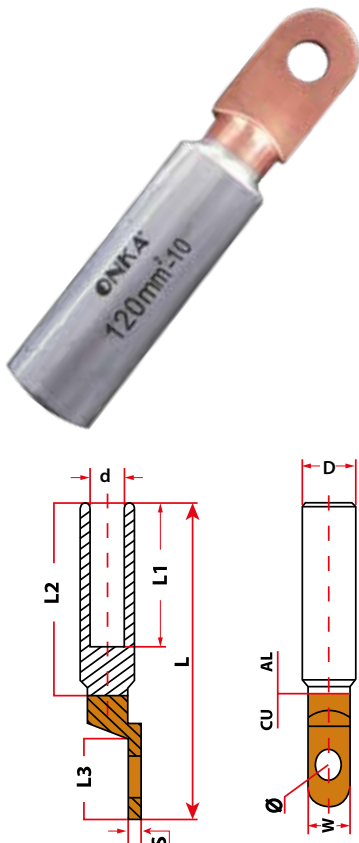

ÜRÜN KODU	KABLO KESİTİ (mm <sup>2</sup> )	D (mm)	d (mm)	L±1 (mm)	L1 (mm)	L2 (mm)	L3 (mm)	W (mm)	Q (mm)	S (mm)	ADET (\$)	KUTU ADEDİ
ONKA-6510	16	16	5,5	82	38	50	23	14,0	8,5	3,2	2,65 \$	80
ONKA-6511	25	16	6,5	82	38	50	23	14,0	8,5	3,2	2,65 \$	80
ONKA-6512	35	16	8,2	82	38	50	23	14,0	8,5	3,2	2,65 \$	80
ONKA-6513	50	20	9,7	94	43	55	27	16,0	8,5	5,2	3,60 \$	60
ONKA-6514	70	20	11	94	43	55	27	16,0	8,5	5,2	3,60 \$	60
ONKA-6515	95	20	12,5	94	43	55	27	16,0	8,5	5,2	3,60 \$	60
ONKA-6516	120	25	14,5	120	60	72	32	23,0	10,5	6,5	6,05 \$	30
ONKA-6517	150	25	16,5	120	60	72	32	23,0	10,5	6,5	6,05 \$	30
ONKA-6518	185	32	17,5	133	60	73	38	23,0	12,5	8	9,80 \$	15
ONKA-6519	240	32	19,5	133	60	73	38	29,0	12,5	8	9,80 \$	15
ONKA-6520	300	34	23	133	61	73	35	29,0	12,5	8,5	14,25 \$	10
ONKA-6521	400	40	26,2	163	93	105	35	29,0	12,5	10,5	16,20 \$	10
ONKA-6522	500	40	29	163	93	105	35	29,0	12,5	10,5	16,20 \$	10

## ALÜMİNYUM-BAKIR EK MUF

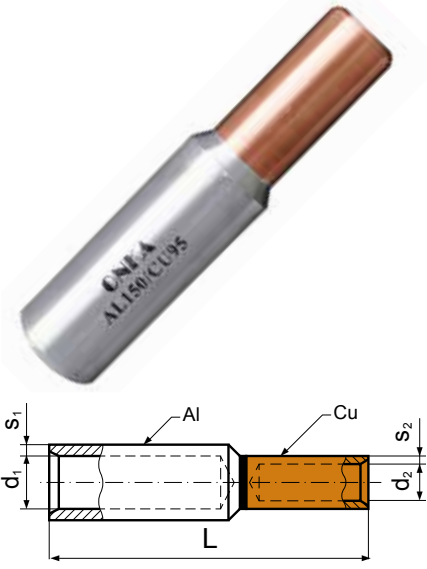

ÜRÜN KODU	AL KABLO KESİTİ (mm <sup>2</sup> )	CU KABLO KESİTİ (mm <sup>2</sup> )	D1 (mm)	D2 (mm)	L (mm)	ADET (\$)	KUTU ADEDİ
ONKA - 6348	16	10	5,5	5,5	75,0	1,10 \$	280
ONKA - 6349	16	16	5,5	5,5	75,0	1,20 \$	280
ONKA - 6350	25	10	5,3	7,3	80,0	1,30 \$	90
ONKA - 6351	35	16	8,0	5,5	71,0	2,00 \$	90
ONKA - 6352	50	25	9,8	5,5	71,5	2,50 \$	80
ONKA - 6353	70	35	11,2	5,5	79,0	3,40 \$	70
ONKA - 6354	95	50	13,2	5,5	79,0	5,00 \$	42
ONKA - 6355	120	70	14,7	5,5	87,0	5,60 \$	35
ONKA - 6356	150	95	16,3	5,5	93,3	6,70 \$	30
ONKA - 6357	185	120	18,3	10,0	108,0	8,60 \$	24
ONKA - 6358	240	150	21,0	10,0	116,0	13,20 \$	16

## ALÜMİNYUM-BAKIR EK MUF (PİNLİ)

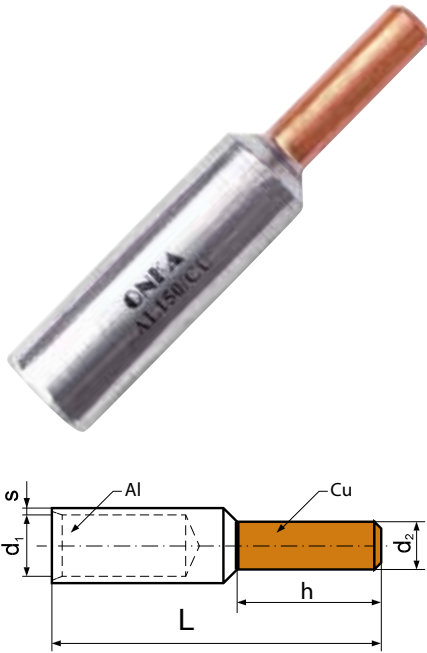

ÜRÜN KODU	KABLO KESİTİ (mm <sup>2</sup> )		ØD1 (mm)	ØD2 (mm)	L (mm)		ADET (\$)	KUTU ADEDİ
	Çok Telli Kablo	Tek Damar Kablo			l	h		
ONKA - 6333	10	16	12	5	58	15	2,20 \$	100
ONKA - 6334	16	25	12	6	58	15	2,20 \$	100
ONKA - 6335	25	35	6,8	6	58	20	2,30 \$	50
ONKA - 6336	35	50	8,0	7	71	22	2,50 \$	50
ONKA - 6337	50	70	9,8	8	74	25	3,00 \$	80
ONKA - 6338	70	95	11,2	10	87	30	3,30 \$	70
ONKA - 6339	95	120	13,2	12	91	33	4,60 \$	48
ONKA - 6340	120	150	14,7	12	97	38	5,50 \$	35
ONKA - 6341	150	185	16,3	12	108	38	5,70 \$	30
ONKA - 6342	185	240	18,3	14	116	44	7,50 \$	24
ONKA - 6343	240	300	21,0	16	128	44	8,40 \$	16
ONKA - 6344	300	-	23,3	18	131	46	10,00 \$	9

## KJB TİP BİMETAL ALÜMİNYUM-BAKIR BAĞLANTI ELEMANI

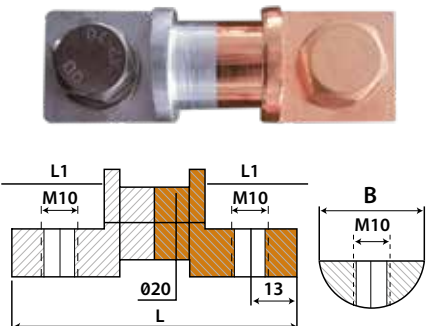

ÜRÜN KODU	VİDA (Ø)	L (mm)	L1 (mm)	B (mm)	ADET (\$)	KUTU ADEDİ
ONKA - 6530	M10	80	26	26	16,00 \$	24
ONKA - 6531	M10	80	26	29	18,00 \$	24



## U KLEMENSLER

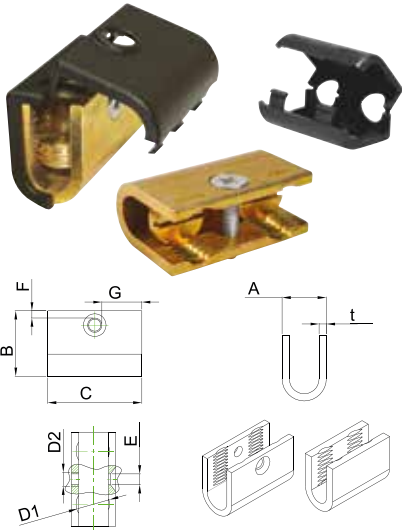

İzolasyon kapağı ürün ile birlikte verilmektedir.

ÜRÜN KODU	KABLO KESİTİ (mm <sup>2</sup> )	VİDA	A	t	B	C	D1	D2	E	F	G	ADET (t)	KUTU ADEDİ
ONKA-7050	6	Çelik	8,5	1,8	13	19	M6	-	-	-	-	135,00	300
ONKA-7051	10	Çelik	10	2,2	15	21	M8	-	-	-	-	165,00	250
ONKA-7052	16	Çelik	12,2	2,3	18,2	28	M10	-	-	-	-	210,00	150
ONKA-7053	25	Çelik	13,8	2,5	20	30,5	7/6"	M5	6	2,25	12	245,00	100
ONKA-7054	35	Çelik	14,5	2,5	23,2	32,5	M12	M5	6	2,25	13,3	285,00	75
ONKA-7055	50	Pirinç	16,2	3	25,4	39	M14	M5	6	2,75	16,6	445,00	50
ONKA-7056	70	Pirinç	19,5	3,25	28,2	43,1	M16	M5	6	4,1	18,5	455,00	40
ONKA-7057	95	Pirinç	21,6	3,25	31,9	45,5	M18	M6	6,5	3,5	19,5	655,00	30
ONKA-7058	120	Pirinç	23,5	3,4	34	50,8	M20	M6	6,5	4	22,15	715,00	20
ONKA-7059	150	Pirinç	28	4,4	39,1	53,9	M22	M6	7	4,4	23,45	1.050,00	10
ONKA-7060	U Klemens Kayığı											Ⓢ	100

## TIRNAKLI KLEMENSLER

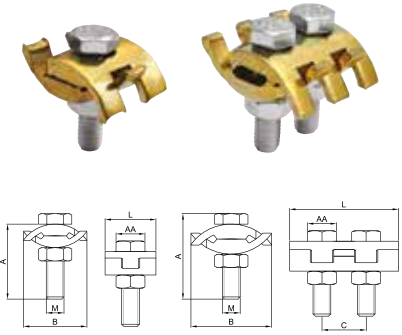

ÜRÜN KODU	CİNSİ	A	B	L	M	AA	C	ADET (t)	KUTU ADEDİ
ONKA-7070	No. 1 16 mm <sup>2</sup>	25	22	17,2	M6	10	-	Ⓢ	500
ONKA-7071	No. 2 25 mm <sup>2</sup>	25	26	20,2	M6	10	-		250
ONKA-7072	No. 3 35 mm <sup>2</sup>	25	28	30,3	M6	10	15		100
ONKA-7073	No. 4 50 mm <sup>2</sup>	25	33	32,4	M6	10	15		100
ONKA-7074	No. 5 70 mm <sup>2</sup>	35	40	35,4	M8	13	17		100
ONKA-7075	No. 6-7 120 mm <sup>2</sup>	35	49	45,1	M6	13	24		50

## KONDANSATÖR KLEMENSLERİ



ÜRÜN KODU	ESKİ KOD	METRİK (Ø)	A X B (mm)	D (mm)	ADET (t)	KUTU ADEDİ
1140016	ONKA-7094	M12 (Ø12,3)	25,5 x 39,2	10	Ⓢ	100
1140017	ONKA-7095	M16 (Ø16,3)	30 x 43,3	9,4		100
1140018	ONKA-7096	M14 (Ø14,5)	25,5 x 39,2	10		100
1140019	ONKA-7097	M14 (Ø14,5)	30 x 43,3	9,4		100
1140020	ONKA-7098	M12 (Ø12,3)	30 x 43,3	9,4		100

## AL - CU / BRANŞMAN / DURDURUCU KLEMENSLER



# Onka®

Profesyonellerin Tercih

## SIRA KLEMENSLER



✓ SIRA KLEMENS

✓ STEATİT KLEMENS

✓ BUAT KLEMENS

✓ SOKET KLEMENS

✓ TRAFÖ KLEMENSİ

✓ MODÜL CİHAZ KLEMENSİ

✓ ASPIRATÖR KLEMENSİ

**VİDA ÇEŞİDİ: DÜZ VE YILDIZ OLARAK**

Elektrikli ev aletleri ve endüstriyel cihazların ürün yaşam döngüsü içinde; periyodik bakım , teknik servis gereksinimi, mobilizasyon kaynaklı demontaj ve montajlar gibi elektrik bağlantılarını da kapsayan işlemlerin her tekrarında güvenli bağlantıyı sağlamak esas amaçtır.

Elektrik bağlantılarının güvenli tekrarlanabilirliği için ise; sıkıştırma ünitesi ana birimleri olan vida ve kafeslerin, sertlik ve gerilme kuvvetlerinin özdeş metallerden oluşması bizlere klasik yöntemlerin (pirinç/çelik – zamak/çelik vb.) ötesinde maksimum performans, kalite ve güvenlik kazandırmaktadır.

ONKA sıra klemenslerin kontak yapısı, özel alaşımlı Ck 45 malzemeden yüksek teknoloji insan odaklı üretim hatalarından etkilenmeyen otomasyon sistemleri ile üretilmektedir. Atmosferik ortamlardan arındırılmış özel dizayn kapalı fırınlarda 36.6 HRC kadar sertleştirilmesi sayesinde ürünün defalarca iletken bağlanıp sökülmesinden kaynaklı deformasyonlara karşı yüksek derecede dayanıklılık sağlanmıştır.

V2 Seri ürünler, gövde yapısı 140°C derece ısıya dayanıma sahip olan Polyamid 6 malzemeden üretilmektedir.

Polyamid 6 hammadde; kopma, eğilme, darbe, aşınma mukavemeti sağlar ve çekme, basma elastikiyeti yüksektir.

Tüm bu termik ve mekanik üstünlükleri ile Polyamid 6 dış ortam koşullarına karşı da maksimum dayanıklı bir ürün elde etmemizi sağlar.

TS EN 60335-1 Standartlarına uygun V0 yanmazlık seviyesinde, 200°C dayanımlı ürün serimiz; Elektrikli ev aletleri ve endüstriyel uygulamalar için özel olarak tasarlanmış yüksek ısıya dayanıklı PA6 gövde yapısıyla tam güvenlik sağlar.

**Farklı kesit - renk - vida - kovan - pin sayılarıyla proje ve ihtiyaçlarınıza özel olarak da üretilmektedir.**

Kontak yapısına uygun sertlik değeri ile üretilen çelik vida ile değişken kullanım koşullarında deforme olmayan bir dayanıklılık kombinasyonu oluşturulmuştur.

ONKA Elektrik, ISO 9001-2015 kalite yönetim sistemi ile yaptığı üretimlerle, kalitesini uluslararası sertifikalar ile tescillemiştir.

### Ürünlerimiz;

Uluslararası kalite gereksinimlerini tam performansla yerine getirirken , Bizlere Ülkemizin de önde gelen Beyaz eşya üreticileri, Sanayi kuruluşları , Savunma Endüstrisi ve Enerji Dağıtım şirketlerince tercih edilen marka olmanın haklı gururunu yaşatmakta, dış ticaret birimimizin faaliyetleriyle 90+ ülkede insanlığa güvenle hizmet ederken , kullanıcılarımızın kendi ürünlerinin önemli bir bileşeni olarak da Dünyanın dört bir yanına ulaşmaktadır

### Referanslarımız;



- Polyamid 6 gövde yapısıyla yüksek sıcaklık , dielektrik ve mekanik performans.
- CK45 Kafes ve çelik vidanın Özdeş sertliğiyle uzun ve güvenli ürün yaşam döngüsü
- Özellikle son kullanıcı , insan odaklı cihaz ve tesislerin güvenliği için optimum bağlantı çözümü.
- 90+ ülkede tercih edilerek uluslararası akredite kurumlarca tescillenerek belgelenmiş yüksek KALİTE!!!

## PLASTİK SIRA KLEMENSLER, VİDA BLOKAJLI - (MAVİ)



ÜRÜN KODU	ESKİ KOD	CİNSİ	GERİLİM (V)	AKIM (A)	ADET (t)	KUTU ADEDİ
1070015	ONKA - 5000	No. 0 0,75 - 1,5 mm <sup>2</sup> lik 12 Sıra	400	17,5	65,90	100
1070016	ONKA - 5001	No. 1 2,5 - 4 mm <sup>2</sup> lik 12 Sıra	400	32	71,85	50
1070017	ONKA - 5002	No. 2 4 - 6 mm <sup>2</sup> lik 12 Sıra	400	41	91,40	50
1070018	ONKA - 5003	No. 3 6 - 10 mm <sup>2</sup> lik 10 Sıra	400	57	95,55	50
1070019	ONKA - 5004	No. 4 10 - 16 mm <sup>2</sup> lik 6 Sıra	500	76	93,15	50
1070020	ONKA - 5005	No. 5 16 - 25 mm <sup>2</sup> lik 6 Sıra	500	101	109,80	50

## ISIYA DAYANIKLI PA6, VİDA BLOKAJLI - (BEYAZ - KIRMIZI) 140 °C V2, TSE, OSK



ÜRÜN KODU	ESKİ KOD	CİNSİ	GERİLİM (V)	AKIM (A)	ADET (t)	KUTU ADEDİ
1070027	ONKA - 5010	No. 0 0,75 - 1,5 mm <sup>2</sup> lik 12 Sıra	400	17,5	68,20	100
1070028	ONKA - 5011	No. 1 2,5 - 4 mm <sup>2</sup> lik 12 Sıra	400	32	74,50	50
1070029	ONKA - 5012	No. 2 4 - 6 mm <sup>2</sup> lik 12 Sıra	400	41	96,25	50
1070030	ONKA - 5013	No. 3 6 - 10 mm <sup>2</sup> lik 10 Sıra	400	57	104,50	50
1070031	ONKA - 5014	No. 4 10 - 16 mm <sup>2</sup> lik 6 Sıra	500	76	102,86	50
1070032	ONKA - 5015	No. 5 16 - 25 mm <sup>2</sup> lik 6 Sıra	500	101	122,35	50
1070033	ONKA - 5016	No. 3 3'lü 6 - 10 mm <sup>2</sup> lik 3 Sıra	400	57	35,10	250

## ISIYA DAYANIKLI, VİDA BLOKAJLI - (ŞEFFAF - POLİKARBON)



ÜRÜN KODU	ESKİ KOD	CİNSİ	GERİLİM (V)	AKIM (A)	ADET (t)	KUTU ADEDİ
1070034	ONKA - 5020	No. 0 0,75 - 1,5 mm <sup>2</sup> lik 12 Sıra	400	17,5	70,50	100
1070035	ONKA - 5021	No. 1 2,5 - 4 mm <sup>2</sup> lik 12 Sıra	400	32	79,20	50
1070036	ONKA - 5022	No. 2 4 - 6 mm <sup>2</sup> lik 12 Sıra	400	41	103,85	50
1070037	ONKA - 5023	No. 3 6 - 10 mm <sup>2</sup> lik 10 Sıra	400	57	112,45	50
1070038	ONKA - 5024	No. 4 10 - 16 mm <sup>2</sup> lik 6 Sıra	500	76	109,25	50
1070039	ONKA - 5025	No. 5 16 - 25 mm <sup>2</sup> lik 6 Sıra	500	101	129,70	50
1070040	ONKA - 5026	No. 3 3'lü 6 - 10 mm <sup>2</sup> lik 3 Sıra	400	57	37,40	250

## ISIYA DAYANIKLI, VİDA BLOKAJLI - (200° PA6-V0)



ÜRÜN KODU	ESKİ KOD	CİNSİ	GERİLİM (V)	AKIM (A)	ADET (t)	KUTU ADEDİ
1070041	ONKA - 5029	No. 0 0,75 - 1,5 mm <sup>2</sup> lik 12 Sıra	400	17,5	74,40	100
1070042	ONKA - 5030	No. 1 2,5 - 4 mm <sup>2</sup> lik 12 Sıra	400	32	83,50	50
1070043	ONKA - 5031	No. 2 4 - 6 mm <sup>2</sup> lik 12 Sıra	400	41	109,00	50
1070044	ONKA - 5032	No. 3 6 - 10 mm <sup>2</sup> lik 10 Sıra	400	57	122,70	50
1070045	ONKA - 5033	No. 4 10 - 16 mm <sup>2</sup> lik 6 Sıra	500	76	121,10	50
1070046	ONKA - 5034	No. 5 16 - 25 mm <sup>2</sup> lik 6 Sıra	500	101	145,10	50
1070047	ONKA - 5035	No. 3 3'lü 6 - 10 mm <sup>2</sup> lik 3 Sıra	400	57	41,00	250

## PALETLİ ISIYA DAYANIKLI, VİDA BLOKAJLI - (BEYAZ - KIRMIZI) 140 °C V2



ÜRÜN KODU	ESKİ KOD	CİNSİ	GERİLİM (V)	AKIM (A)	ADET (t)	KUTU ADEDİ
1070048	ONKA - 5040	No. 1 2.5 - 4 mm <sup>2</sup> lik 12 Sıra	400	32	89,90	50
1070049	ONKA - 5041	No. 2 4 - 6 mm <sup>2</sup> lik 12 Sıra	400	41	114,30	50
1070050	ONKA - 5042	No. 3 6 - 10 mm <sup>2</sup> lik 10 Sıra	400	57	123,00	50
1070051	ONKA - 5043	No. 3 3'lü 6 - 10 mm <sup>2</sup> lik 3 Sıra	400	57	40,00	250

## PALETLİ ISIYA DAYANIKLI, VİDA BLOKAJLI - (ŞEFFAF - POLİKARBON)



ÜRÜN KODU	ESKİ KOD	CİNSİ	GERİLİM (V)	AKIM (A)	ADET (t)	KUTU ADEDİ
1070052	ONKA - 5050	No. 1 2.5 - 4 mm <sup>2</sup> lik 12 Sıra	400	32	96,90	50
1070053	ONKA - 5051	No. 2 4 - 6 mm <sup>2</sup> lik 12 Sıra	400	41	124,20	50
1070054	ONKA - 5052	No. 3 6 - 10 mm <sup>2</sup> lik 10 Sıra	400	57	133,10	50
1070055	ONKA - 5053	No. 3 3'lü 6 - 10 mm <sup>2</sup> lik 3 Sıra	400	57	42,20	250

## PALETLİ ISIYA DAYANIKLI, VİDA BLOKAJLI - (200 °C - PA6-V0)



ÜRÜN KODU	ESKİ KOD	CİNSİ	GERİLİM (V)	AKIM (A)	ADET (t)	KUTU ADEDİ
1070056	ONKA - 5056	No. 1 2.5 - 4 mm <sup>2</sup> lik 12 Sıra	400	32	98,25	50
1070057	ONKA - 5057	No. 2 4 - 6 mm <sup>2</sup> lik 12 Sıra	400	41	131,00	50
1070058	ONKA - 5058	No. 3 6 - 10 mm <sup>2</sup> lik 10 Sıra	400	57	143,50	50
1070059	ONKA - 5059	No. 3 3'lü 6 - 10 mm <sup>2</sup> lik 3 Sıra	400	57	45,80	250

## ÖZEL KESİMLİ SIRA KLEMENSLER (DÜZ-YILDIZ BAŞLI VİDALI)



ÜRÜN KODU	ESKİ KOD	CİNSİ	GERİLİM (V)	AKIM (A)	ADET (t)	
1070097	ONKA - 5575	No:1 2,5-4mm <sup>2</sup> V0 Paletli Yüksek Isıya Dayanıklı 1'li	400	32		Ⓢ
1070127	ONKA - 5883	No:1 2,5-4mm <sup>2</sup> Polipropilen Plastik 2'li	400	32		
1070132	ONKA - 5889	No:1 2,5-4mm <sup>2</sup> V0 Yüksek Isıya Dayanıklı 3'lü	400	32		
1070271	ONKA - 5296	No:1 2,5-4mm <sup>2</sup> V0 Yüksek Isıya Dayanıklı 4'lü	400	32		
1070274	ONKA - 5819	No:2 4-6mm <sup>2</sup> V0 Paletli Yüksek Isıya Dayanıklı 2'li	400	41		
1070101	ONKA - 5804	No:2 4-6mm <sup>2</sup> Poliamit 2'li	400	41		
1070104	ONKA - 5812	No:2 4-6mm <sup>2</sup> V0 Paletli Yüksek Isıya Dayanıklı 3'lü	400	41		
1070084	ONKA - 5121	No:2 4-6mm <sup>2</sup> Poliamit 3'lü	400	41		
1070073	ONKA - 5821	No:3 6-10mm <sup>2</sup> V0 Paletli Yüksek Isıya Dayanıklı 6'lı	400	57		
1070124	ONKA - 5871	No:4 10-16mm <sup>2</sup> V0 Yüksek Isıya Dayanıklı 4'lü	500	76		
1070074	ONKA - 5047	No:5 16-25mm <sup>2</sup> V0 Yüksek Isıya Dayanıklı 5'li	500	101		

## PRATİK BAĞLANTILI SIRA KLEMENSLER (YAY BAĞLANTILI)

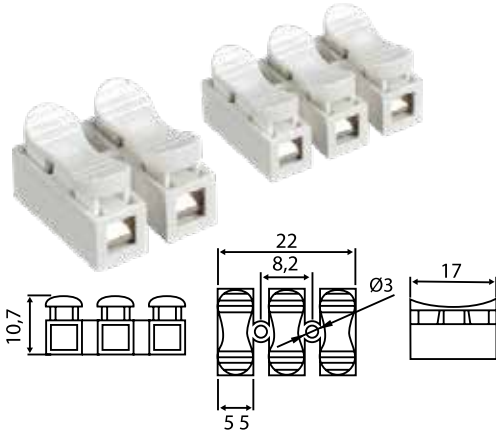

ÜRÜN KODU	AÇIKLAMA	ADET (\$)	KUTU ADEDİ
ONKA - 8850	1,5 mm <sup>2</sup> - 2 Kutuplu Pratik Bağlantılı Sıra Klemens	0,060 \$	100
ONKA - 8851	1,5 mm <sup>2</sup> - 3 Kutuplu Pratik Bağlantılı Sıra Klemens	0,092 \$	100
ONKA - 8852	2,5 mm <sup>2</sup> - 2 Kutuplu Pratik Bağlantılı Sıra Klemens	0,092 \$	100
ONKA - 8853	2,5 mm <sup>2</sup> - 3 Kutuplu Pratik Bağlantılı Sıra Klemens	0,120 \$	100
ONKA - 8854	2,5 mm <sup>2</sup> - 12 Kutuplu Pratik Bağlantılı Sıra Klemens	0,728 \$	100
ONKA - 8855	4 mm <sup>2</sup> - 2 Kutuplu Pratik Bağlantılı Sıra Klemens	0,244 \$	100
ONKA - 8856	4 mm <sup>2</sup> - 3 Kutuplu Pratik Bağlantılı Sıra Klemens	0,304 \$	100

## AYDINLATMA - ARMATÜR KLEMENSLERİ (YAY BAĞLANTILI)



ÜRÜN KODU	AÇIKLAMA	ADET (\$)	KUTU ADEDİ
ONKA - 8860	2 Kutup / 3 Pinli Aydınlatma-Armatür Klemensi	0,424 \$	100
ONKA - 8861	3 Kutup / 3 Pinli Aydınlatma-Armatür Klemensi	0,576 \$	100
ONKA - 8862	4 Kutup / 3 Pinli Aydınlatma-Armatür Klemensi	0,820 \$	100
ONKA - 8863	5 Kutup / 3 Pinli Aydınlatma-Armatür Klemensi	1,032 \$	100

## TRAFÖ KLEMENSLERİ VE ETİKETLERİ



ÜRÜN KODU	CİNSİ	GERİLİM (V)	AKIM (A)	ADET (₺)	KUTU ADEDİ
ONKA - 5135	1 x 4 mm <sup>2</sup> Yüksek Tip	400	24	60,50	200
ONKA - 5136	2 x 4 mm <sup>2</sup> Yüksek Tip	400	24	85,50	100
ONKA - 5138	3 x 4 mm <sup>2</sup> Yüksek Tip	400	24	⚡	75
ONKA - 5139	4 x 4 mm <sup>2</sup> Yüksek Tip	400	24	⚡	50
ONKA - 5137	1 x 6 mm <sup>2</sup> Yüksek Tip	400	41	67,50	100

ÜRÜN KODU	ESKİ KOD	CİNSİ	ADET (₺)	KUTU ADEDİ
1060204	ONKA - 5139	Trafo Klemens Etiketli Yazısız	1,20	500
1060205	ONKA - 5140	Trafo Klemens Etiketli Yazılı	2,60	500

## KAPAKLI TERMİNAL KLEMENSLER 25 A



ÜRÜN KODU	CİNSİ	GERİLİM (V)	AKIM (A)	ADET (₺)	KUTU ADEDİ
ONKA - 5145	Terminal - 3	600	25	25,00	50
ONKA - 5146	Terminal - 4			32,00	50
ONKA - 5147	Terminal - 6			50,00	50
ONKA - 5148	Terminal - 12			92,00	25

## MİNİ KLEMENS (Aspiratör Klemensi)



RENK	ÜRÜN KODU	ESKİ KOD	CİNSİ	GERİLİM (V)	AKIM (A)	ADET (t)	KUTU ADEDİ
⇨	1070257	ONKA - 5130	Mini klemens (Aspiratör) 2.5 - 4 mm <sup>2</sup>	400	32	15,45	250
➡	1070258	ONKA - 5131					

## 2'Lİ MODÜLER SİSTEM SOKET KLEMENSLER (MS 58 PİRİNÇ İLETKEN - 24 A)



RENK	ÜRÜN KODU	CİNSİ	GERİLİM (V)	AKIM (A)	ADET (t)	KUTU ADEDİ
⇨	ONKA - 5068	NO. 1 - 2'li Soket Klemensi + Modüler Sistem (2,5 - 4mm <sup>2</sup> )	450	24	96,80	180
➡	ONKA - 5451					
➡	ONKA - 5452					
➡	ONKA - 5453					
➡	ONKA - 5454					

## 12'Lİ SOKET KLEMENS (MS 58 PİRİNÇ İLETKEN - 24 A)



RENK	ÜRÜN KODU	CİNSİ	GERİLİM (V)	AKIM (A)	ADET (t)	KUTU ADEDİ
⇨	ONKA - 5060	No. 1-12 2.5 - 4 mm <sup>2</sup> lik (Erkek Dişi Geçmeli Kilitli)	450	24	515,00	30
➡	ONKA - 5401					
➡	ONKA - 5402					
➡	ONKA - 5403					
➡	ONKA - 5404					
➡	ONKA - 5405					

## 3'LÜ SOKET KLEMENS (MS 58 PİRİNÇ İLETKEN - 24 A)



RENK	ÜRÜN KODU	Cinsi	GERİLİM (V)	AKIM (A)	ADET (t)	KUTU ADEDİ
☐	ONKA - 5065	NO. 1 3'lü Soket Klemensi (2,5 - 4mm <sup>2</sup> )	450	24	145,00	100
■	ONKA - 5411					
☐	ONKA - 5066	Soket Klemensi Kapağı (Takım)			63,50	45
■	ONKA - 5421					
☐	ONKA - 5067	NO. 1 3'lü Soket Klemensi + Kapak Takımı (2,5 - 4mm <sup>2</sup> )			208,50	45
■	ONKA - 5431					

## 3'LÜ SOKET KLEMENS T BAĞLANTI APARATI (MS 58 PİRİNÇ İLETKEN - 24 A)



RENK	ÜRÜN KODU	Cinsi	GERİLİM (V)	AKIM (A)	ADET (t)	KUTU ADEDİ
☐	ONKA - 5074	2,5 - 4 mm <sup>2</sup> T Bağlantı Aparatı	450	24	469,00	60
■	ONKA - 5075					

## 6'LI SOKET KLEMENS BAĞLANTI APARATI (MS 58 PİRİNÇ İLETKEN - 24 A)



RENK	ÜRÜN KODU	Cinsi	GERİLİM (V)	AKIM (A)	ADET (t)	KUTU ADEDİ
☐	ONKA - 5064	No:1 2,5 - 4 mm <sup>2</sup> 6'lı Soket Kapak Takım	450	24	459,50	16
■	ONKA - 5063					

## MODÜL CİHAZ KLEMENSLERİ



RENK	ÜRÜN KODU	ESKİ KOD	CİNSİ	AKIM (A)	GERİLİM (V)	ADET (t)	KUTU ADEDİ
●	<b>1070182</b>	ONKA - 5100	No 1 (2,5 - 4 mm <sup>2</sup> )	32 A	400 V	<b>18,60</b>	250
●	<b>1070196</b>	ONKA - 5101	No 2 (4 - 6 mm <sup>2</sup> )	41 A	400 V	<b>23,40</b>	144
●	<b>1070204</b>	ONKA - 5102	No 3 (6 - 10 mm <sup>2</sup> )	57 A	400 V	<b>34,25</b>	75
●	<b>1070188</b>	ONKA - 5103	No 1-3'lü (2,5 - 4 mm <sup>2</sup> )	32 A	400 V	<b>28,20</b>	200
●	<b>1070186</b>	ONKA - 5163	No 1 (2,5 - 4 mm <sup>2</sup> )	32 A	400 V	<b>18,60</b>	250
●	<b>1070200</b>	ONKA - 5183	No 2 (4 - 6 mm <sup>2</sup> )	41 A	400 V	<b>23,40</b>	144
●	<b>1070207</b>	ONKA - 5193	No 3 (6 - 10 mm <sup>2</sup> )	57 A	400 V	<b>34,25</b>	75
●	<b>1070192</b>	ONKA - 5173	No 1-3'lü (2,5 - 4 mm <sup>2</sup> )	32 A	400 V	<b>28,20</b>	200
●	<b>1070187</b>	ONKA - 5164	No 1 (2,5 - 4 mm <sup>2</sup> )	32 A	400 V	<b>18,60</b>	250
●	<b>1070201</b>	ONKA - 5184	No 2 (4 - 6 mm <sup>2</sup> )	41 A	400 V	<b>23,40</b>	144
●	<b>1070208</b>	ONKA - 5194	No 3 (6 - 10 mm <sup>2</sup> )	57 A	400 V	<b>34,25</b>	75
●	<b>1070193</b>	ONKA - 5174	No 1-3'lü (2,5 - 4 mm <sup>2</sup> )	32 A	400 V	<b>28,20</b>	200
●	<b>1070184</b>	ONKA - 5161	No 1 (2,5 - 4 mm <sup>2</sup> )	32 A	400 V	<b>18,60</b>	250
●	<b>1070198</b>	ONKA - 5181	No 2 (4 - 6 mm <sup>2</sup> )	41 A	400 V	<b>23,40</b>	144
●	<b>1070205</b>	ONKA - 5191	No 3 (6 - 10 mm <sup>2</sup> )	57 A	400 V	<b>34,25</b>	75
●	<b>1070190</b>	ONKA - 5171	No 1-3'lü (2,5 - 4 mm <sup>2</sup> )	32 A	400 V	<b>28,20</b>	200
○	<b>1070183</b>	ONKA - 5104	No 1 (2,5 - 4 mm <sup>2</sup> )	32 A	400 V	<b>18,60</b>	250
○	<b>1070197</b>	ONKA - 5105	No 2 (4 - 6 mm <sup>2</sup> )	41 A	400 V	<b>23,40</b>	144
○	<b>1070203</b>	ONKA - 5106	No 3 (6 - 10 mm <sup>2</sup> )	57 A	400 V	<b>34,25</b>	75
○	<b>1070189</b>	ONKA - 5107	No 1-3'lü (2,5 - 4 mm <sup>2</sup> )	32 A	400 V	<b>28,20</b>	200
●	<b>1070185</b>	ONKA - 5162	No 1 (2,5 - 4 mm <sup>2</sup> )	32 A	400 V	<b>18,60</b>	250
●	<b>1070199</b>	ONKA - 5182	No 2 (4 - 6 mm <sup>2</sup> )	41 A	400 V	<b>23,40</b>	144
●	<b>1070206</b>	ONKA - 5192	No 3 (6 - 10 mm <sup>2</sup> )	57 A	400 V	<b>34,25</b>	75
●	<b>1070191</b>	ONKA - 5172	No 1-3'lü (2,5 - 4 mm <sup>2</sup> )	32 A	400 V	<b>28,20</b>	200



# STEATİT KLEMENSLER

## STEATİT KLEMENSLERİN ÜSTÜNLÜKLERİ

Steatit; elektroteknikte yalıtkan parçaların üretiminde kullanılan, klasik elektroporselene nazaran çok daha yüksek elektriksel ve mekaniksel dayanıma sahip bir malzeme olarak tanımlanabilir.

Elektrik enerjisi tüketiminin, içerisinde bulunduğumuz yüzyılda hızla artış göstermesi, üretim, iletim ve kullanım safhalarında seramik izolasyon malzemelerine olan talebi de hızla arttırmıştır. Hidroelektrik, termik, nükleer enerji v.b. gibi santrallerin dağıtım ve iletim ünitelerinde yüksek güçleri taşıyabilecek seramik izolatörlerin yanında, yüksek izolasyon sağlayabilen seramik aksam ve parçaların özelliklerinin iyileştirilmesi ihtiyacı ön plana çıkmıştır.

Elektroporselenin bu noktadan itibaren ihtiyaçlara cevap veremediği görülmüş ve 1930'lardan itibaren elektrik izolatörlerinde porselen yerine steatit kullanımı yaygınlaşmaya başlamıştır.



### Referanslarımız;

**INOXSAN**

**öztiryakiler**

## STEATİT KLEMENSİN PORSELEN KLEMENSE GÖRE ÜSTÜNLÜKLERİ

- Daha yüksek mekaniksel dayanıma,
- Daha yüksek boyutsal kararlılığa,
- Daha yüksek sıcaklık dayanımına (500 °C),
- Daha yüksek asit dayanımına,
- Daha uzun kullanım ömrüne,
- Daha yalıtkan bir yüzeye sahip ve yüzeyel elektrik kaçağı sıfır olan, çok üstün bir malzemedir.

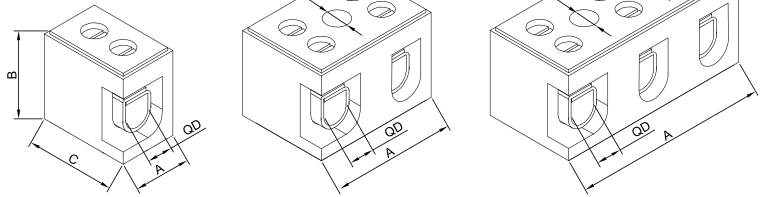

ONKA Steatit klemenslerin kontak malzemesi özel alaşımlı çeliktir ve çalışma sıcaklığı 500 °C 'de sertifikalandırılmıştır.. (Piyasadaki elektroporselen klemenslerin kontakları 350 °C'ye kadar ısıya dayanıklı olduğundan daha yüksek ısı dayanımı gerekli yerlerde kullanımı sakıncalıdır.)

ÜRÜN KODU	ESKİ KOD	EBAT	Pole	A (mm)	B (mm)	C (mm)	D Ø (mm)	M Ø (mm)	ADET (t)	KUTU ADEDİ
1070001	ONKA-5081	No. 0/2	2	22	16,5	18,5	4	4,3	30,40	100
1070002	ONKA-5082	No. 1/2	2	22,5	17	19	5	4,3	33,20	150
1070003	ONKA-5083	No. 1/3	3	36	17	19	5	4,3	46,80	100
1070004	ONKA-5084	No. 2/2	2	27	18,5	22	6	4,3	40,45	100
1070005	ONKA-5085	No. 2/3	3	40	18,5	22	6	4,3	55,90	50
1070006	ONKA-5086	No. 3/2	2	34	24,5	30	7	5,2	67,95	50
1070007	ONKA-5087	No. 3/3	3	51,5	25	30	7	5,2	95,80	35
1070008	ONKA-5088	No. 0/1	1	11	16,5	18,5	4	-	24,60	200
1070009	ONKA-5089	No. 1/1	1	11,5	17	19	5	-	24,45	200
1070010	ONKA-5090	No. 2/1	1	12	18,8	22	6	-	29,30	150
1070011	ONKA-5091	No. 3/1	1	17	25	30,3	7	-	42,70	100
1070013	ONKA-5094	No. 4-5/3	3	65,6	30	30	11	5,2	160,40	20
1070014	ONKA-5095	No. 4-5/2	2	42	30	30	11	5,2	143,90	20

## AÇ KAPA BUAT KLEMENSİ (TÜM KABLO ÇEŞİTLERİ İÇİN)

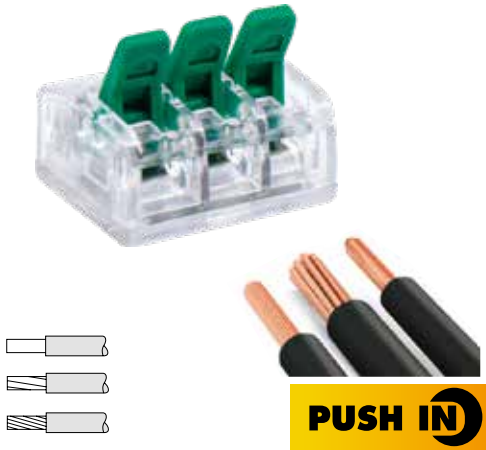

ÜRÜN KODU	KUTUP SAYISI	KABLO KESİTİ	GERİLİM (V)	AKIM (A)	ADET (\$)	KUTU ADEDİ
ONKA-8840	2	0,2 - 4mm <sup>2</sup>	450V	32A	0,22 \$	100
ONKA-8842	3				0,27 \$	100
ONKA-8843	4				0,33 \$	100
ONKA-8844	5				0,40 \$	100

## GEÇMELİ BUAT KLEMENSLER (ŞEFFAF ve RENKLİ)

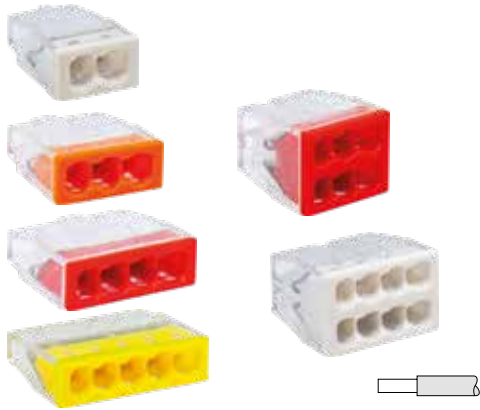

ÜRÜN KODU	KUTUP SAYISI	KABLO KESİTİ	GERİLİM (V)	AKIM (A)	ADET (\$)	KUTU ADEDİ
ONKA - 8320	2	0.5 - 2.5 mm <sup>2</sup>	450V	24A	0,13 \$	100
ONKA - 8321	3				0,16 \$	100
ONKA - 8322	4				0,19 \$	100
ONKA - 8323	5				0,22 \$	100
ONKA - 8463	6				0,25 \$	100
ONKA - 8324	8				0,28 \$	100

## SOKETLİ AÇ/KAPA BUAT KLEMENSLER

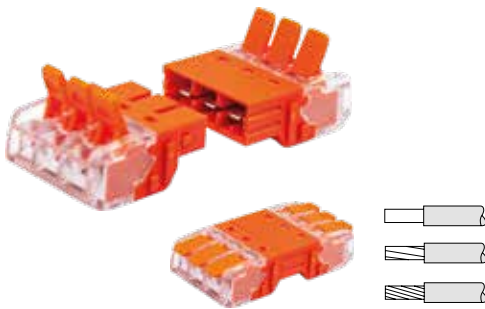

ÜRÜN KODU	KUTUP SAYISI	KABLO KESİTİ	GERİLİM (V)	AKIM (A)	ADET (\$)	KUTU ADEDİ
ONKA - 8880-2	2	0.2 - 4 mm <sup>2</sup>	450V	32A	1,44 \$	30
ONKA - 8880-3	3				1,90 \$	20
ONKA - 8880-4	4				2,90 \$	20

## ÇİFT YÖNLÜ AÇ/KAPA BUAT KLEMENSLER



ÜRÜN KODU	KUTUP SAYISI	KABLO KESİTİ	GERİLİM (V)	AKIM (A)	ADET (\$)	KUTU ADEDİ
ONKA - 8890-1	1	0.2 - 4 mm <sup>2</sup>	450V	32A	0,45 \$	50
ONKA - 8890-2	2				0,54 \$	50
ONKA - 8890-3	3				0,76 \$	40

## VIDALI ŞEFFAF (RENKLİ) BUAT İÇİ KLEMENS

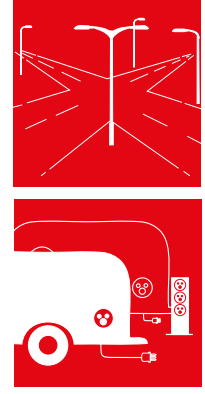
 2,5 ..... 120 mm<sup>2</sup>

ÜRÜN KODU	ESKİ KOD	NO	BAĞLANTI KESİTİ	GERİLİM (V)	AKIM (A)	ADET (t)	KUTU ADEDİ
1070214	ONKA - 5504	1	Ø Max. 1,5 - 4 mm <sup>2</sup> (2 x 1,5 mm <sup>2</sup> )	500 V	16 A	5,45	600
1070221	ONKA - 5514	2	Ø Max. 2,5 - 6 mm <sup>2</sup> (2 x 2,5 mm <sup>2</sup> )	500 V	24 A	6,45	600
1070228	ONKA - 5524	3	Ø Max. 2,5 - 10 mm <sup>2</sup> (2 x 6 mm <sup>2</sup> )	500 V	41 A	8,00	600
1070235	ONKA - 5534	4	Ø Max. 2,5 - 16 mm <sup>2</sup> (2 x 10 mm <sup>2</sup> )	500 V	57 A	10,75	500
1070242	ONKA - 5544	5	Ø Max. 2,5 - 35 mm <sup>2</sup> (2 x 16 mm <sup>2</sup> )	500 V	76 A	15,85	500
1070248	ONKA - 5554	6	Ø Max. 2,5 - 50 mm <sup>2</sup> (2 x 25 mm <sup>2</sup> )	500 V	101 A	29,75	200
80012142	ONKA - 5578	7	Ø Max. 2,5 - 70 mm <sup>2</sup> (2 x 35 mm <sup>2</sup> )	500 V	125 A	Ⓢ	
80012143	ONKA - 5579	8	Ø Max. 2,5 - 120 mm <sup>2</sup> (2 x 50 mm <sup>2</sup> )	500 V	150 A	Ⓢ	



## AYDINLATMA DİREK İÇİ KLEMENS

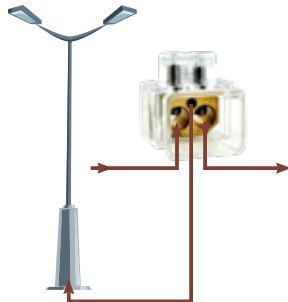

ÜRÜN KODU	BAĞLANTI KESİTİ	GERİLİM (V)	AKIM (A)	ADET (\$)	KUTU ADEDİ
ALT 6002300050	1x1,5 - 4 mm <sup>2</sup> 2x10 - 35 mm <sup>2</sup>	500 V	125 A	7,20 \$	90

## VİDALI YİVLİ BUAT KLEMENLERİ

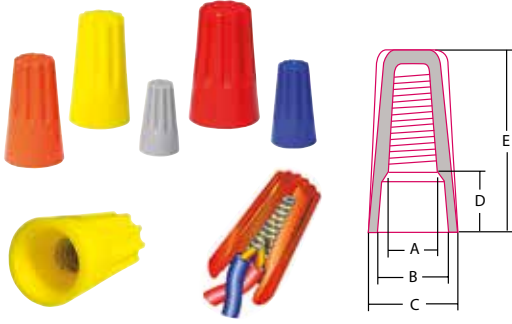

ÜRÜN KODU	RENK	A	B	C	D	E	ADET (\$)	KUTU ADEDİ
ONKA - 8340 / P-1	→	3.80	6.70	8.60	5.80	15.20	0,033 \$	1000
ONKA - 8341 / P-2	→	4.10	7.00	9.80	5.90	17.60	0,042 \$	1000
ONKA - 8342 / P-3	→	5.00	9.90	12.20	7.80	22.00	0,056 \$	500
ONKA - 8343 / P-4	→	6.00	11.20	14.00	7.90	24.00	0,075 \$	500
ONKA - 8344 / P-6	→	7.50	13.00	16.40	9.15	26.50	0,134 \$	500

Dayanıklı Termoplastik hammaddeden imal edilmiş olup, UL 94 / V2 normunda 105 °C çalışma sıcaklığında, bina elektrik tesisatları için 600 V, aydınlatma ve sinyalizasyon için 1000 V'a dayanabilme özelliğine sahiptir.

## YÜKSÜKLÜ BUAT KLEMENSİ (ŞEFFAF)

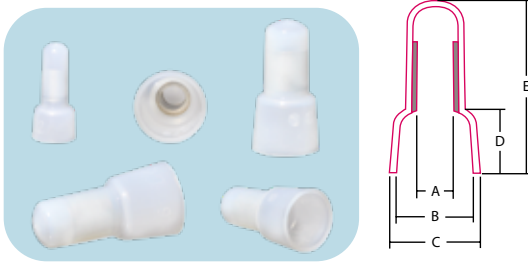

ÜRÜN KODU	A	B	C	D	E	ADET (\$)	KUTU ADEDİ
ONKA - 8330 CE-1	2.6	6.2	7.8	6.2	18.0	0,026 \$	1000
ONKA - 8331 CE-2	3.1	7.9	9.5	7.2	19.7	0,032 \$	1000
ONKA - 8332 CE-5	4.1	10.5	12.5	9.6	25.5	0,045 \$	1000
ONKA - 8333 CE-8	5.3	12.4	14.6	12.0	27.7	0,189 \$	500

Naylon 66 hammaddeden imal edilmiş olup, UL 94 / V2 normunda, 105 °C çalışma sıcaklığında 300 Volt Gerilime Dayanabilme özelliğine Sahiptir. (CE - 8) Modeli 600 Volt Gerilime Dayanabilme.

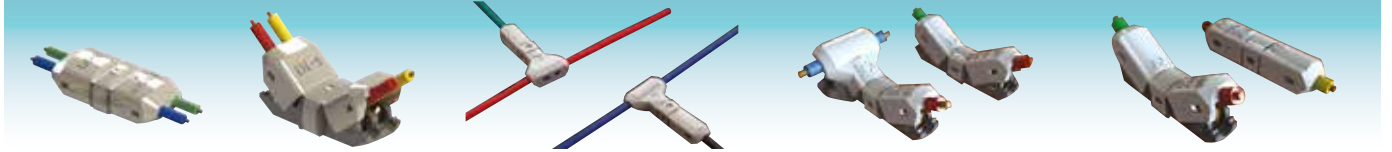

## I TİPİ PRATİK BAĞLANTI KLEMENLERİ

ÜRÜN KODU	AÇIKLAMA	ADET (\$)	KUTU ADEDİ
ONKA - I1	3A Beyaz 0,3 ~ 0,5 mm <sup>2</sup>	0,40 \$	100
ONKA - I2	10A Gri 0,6 ~ 1,0 mm <sup>2</sup>	0,48 \$	100
ONKA - I3	15A Sarı 1,5 mm <sup>2</sup>	0,72 \$	100
ONKA - I4	20A Yeşil 2,5 mm <sup>2</sup>	1,00 \$	100
ONKA - I5	25A Turuncu 4,0 mm <sup>2</sup>	1,32 \$	100

ÜRÜN KODU	AÇIKLAMA	ADET (\$)	KUTU ADEDİ
ONKA - DI - 1	3A Beyaz 0,3 ~ 0,5 mm <sup>2</sup>	0,68 \$	100
ONKA - DI - 21	10A Gri (I) Giriş: 0,75 ~ 1,0 mm <sup>2</sup> (I) Çıkış: 0,2 ~ 0,5 mm <sup>2</sup>	0,88 \$	100

## T TİPİ PRATİK BAĞLANTI KLEMENLERİ

ÜRÜN KODU	AÇIKLAMA	ADET (\$)	KUTU ADEDİ
ONKA - T2	10A Gri 0,6 ~ 1,0 mm <sup>2</sup>	0,60 \$	100
ONKA - T5	25A Turuncu 4,0 mm <sup>2</sup>	1,52 \$	100
ONKA - T - 21	3A Gri (T) Giriş: 0,6 ~ 1,0 mm <sup>2</sup> (I) Çıkış: 0,2 ~ 0,5 mm <sup>2</sup>	0,48 \$	100

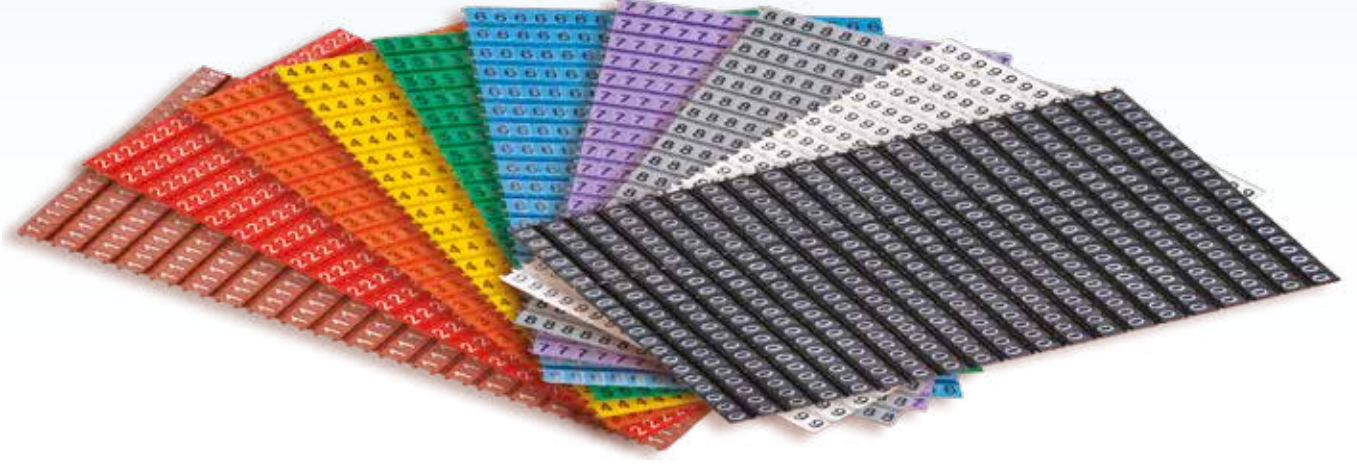

## KABLO ve PANO AKSESUARLARI

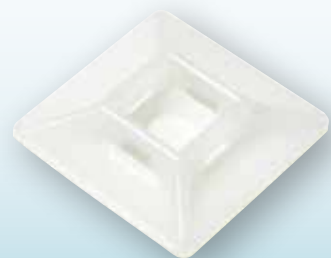

## KCG TİPİ KABLO ETİKETLERİ

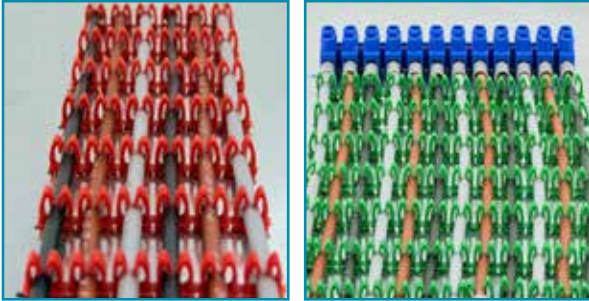
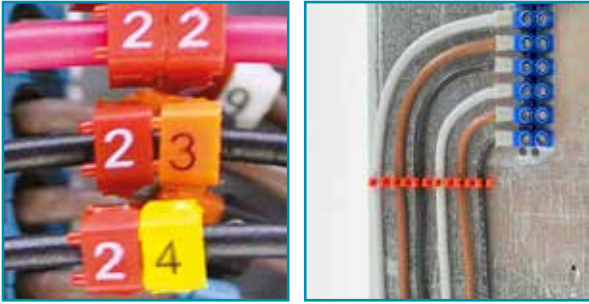

ÖLÇÜ (mm)	NO	A	B	C	D
	1	4,4	3	2,5	2,7
	2	5	3	2,5	3,2
	3	7,4	3	2,5	4,9

### TEKNİK DETAY

HAMMADDE	PA6.6
ÇALIŞMA SICAKLIĞI	-40 OC, +140 OC
YAZI RENGİ	Siyah & Beyaz
UYGUN KABLO KESİTLERİ	No1 : 0,75 - 1,50 mm2 No2 : 1,50 - 2,50 mm2 No3 : 4,00 - 6,00 mm2

NO:1

0,75 - 1,50 mm<sup>2</sup>

ÜRÜN KODU	ESKİ KOD	BASKI	ADET (t)	KUTU / KOLİ ADEDİ
1150006	ONKA-9848	0 BASKILI	0,67	400/20.000
1150007	ONKA-9849	1 BASKILI	0,67	400/20.000
1150013	ONKA-9852	2 BASKILI	0,67	400/20.000
1150014	ONKA-9853	3 BASKILI	0,67	400/20.000
1150015	ONKA-9854	4 BASKILI	0,67	400/20.000
1150016	ONKA-9855	5 BASKILI	0,67	400/20.000
1150017	ONKA-9856	6 BASKILI	0,67	400/20.000
1150018	ONKA-9857	7 BASKILI	0,67	400/20.000
1150019	ONKA-9858	8 BASKILI	0,67	400/20.000
1150020	ONKA-9859	9 BASKILI	0,67	400/20.000
1150027	ONKA-9866	A BASKILI	0,67	400/20.000
1150028	ONKA-9867	B BASKILI	0,67	400/20.000
1150029	ONKA-9868	C BASKILI	0,67	400/20.000
1150030	ONKA-9869	D BASKILI	0,67	400/20.000
1150031	ONKA-9870	E BASKILI	0,67	400/20.000
1150032	ONKA-9871	F BASKILI	0,67	400/20.000
1150033	ONKA-9872	G BASKILI	0,67	400/20.000
1150034	ONKA-9873	H BASKILI	0,67	400/20.000
1150035	ONKA-9874	I BASKILI	0,67	400/20.000
1150036	ONKA-9875	J BASKILI	0,67	400/20.000
1150037	ONKA-9876	K BASKILI	0,67	400/20.000
1150038	ONKA-9877	L BASKILI	0,67	400/20.000
1150040	ONKA-9879	M BASKILI	0,67	400/20.000
1150041	ONKA-9880	N BASKILI	0,67	400/20.000
1150042	ONKA-9881	O BASKILI	0,67	400/20.000
1150043	ONKA-9882	P BASKILI	0,67	400/20.000
1150045	ONKA-9884	R BASKILI	0,67	400/20.000
1150046	ONKA-9885	S BASKILI	0,67	400/20.000
1150048	ONKA-9887	T BASKILI	0,67	400/20.000
1150049	ONKA-9888	U BASKILI	0,67	400/20.000
1150050	ONKA-9889	V BASKILI	0,67	400/20.000
1150051	ONKA-9890	W BASKILI	0,67	400/20.000
1150052	ONKA-9891	X BASKILI	0,67	400/20.000
1150053	ONKA-9892	Y BASKILI	0,67	400/20.000
1150054	ONKA-9893	Z BASKILI	0,67	400/20.000
1150039	ONKA-9878	Mp BASKILI	0,67	400/20.000
1150024	ONKA-9863	+ BASKILI	0,67	400/20.000
1150021	ONKA-9860	- BASKILI	0,67	400/20.000
1150047	ONKA-9886	± BASKILI	0,67	400/20.000
1150023	ONKA-9862	~ BASKILI	0,67	400/20.000
1150044	ONKA-9883	Q BASKILI	0,67	400/20.000
1150026	ONKA-9865	AC BASKILI	0,67	400/20.000

**NO:2 1,50 - 2,50 mm<sup>2</sup>**

ÜRÜN KODU	ESKİ KOD	BASKI	ADET (t)	KUTU / KOLİ ADEDİ
1150004	ONKA-9846	0 BASKILI	0,91	400/20.000
1150005	ONKA-9847	1 BASKILI	0,91	400/20.000
1150057	ONKA-9896	2 BASKILI	0,91	400/20.000
1150058	ONKA-9897	3 BASKILI	0,91	400/20.000
1150059	ONKA-9898	4 BASKILI	0,91	400/20.000
1150060	ONKA-9899	5 BASKILI	0,91	400/20.000
1150061	ONKA-9900	6 BASKILI	0,91	400/20.000
1150062	ONKA-9901	7 BASKILI	0,91	400/20.000
1150063	ONKA-9902	8 BASKILI	0,91	400/20.000
1150064	ONKA-9903	9 BASKILI	0,91	400/20.000
1150072	ONKA-9911	A BASKILI	0,91	400/20.000
1150073	ONKA-9912	B BASKILI	0,91	400/20.000
1150074	ONKA-9913	C BASKILI	0,91	400/20.000
1150075	ONKA-9914	D BASKILI	0,91	400/20.000
1150076	ONKA-9915	E BASKILI	0,91	400/20.000
1150077	ONKA-9916	F BASKILI	0,91	400/20.000
1150078	ONKA-9917	G BASKILI	0,91	400/20.000
1150079	ONKA-9918	H BASKILI	0,91	400/20.000
1150080	ONKA-9919	I BASKILI	0,91	400/20.000
1150081	ONKA-9920	J BASKILI	0,91	400/20.000
1150082	ONKA-9921	K BASKILI	0,91	400/20.000
1150086	ONKA-9925	L BASKILI	0,91	400/20.000
1150088	ONKA-9927	M BASKILI	0,91	400/20.000
1150089	ONKA-9928	N BASKILI	0,91	400/20.000
1150090	ONKA-9929	O BASKILI	0,91	400/20.000
1150091	ONKA-9930	P BASKILI	0,91	400/20.000
1150093	ONKA-9932	R BASKILI	0,91	400/20.000
1150094	ONKA-9933	S BASKILI	0,91	400/20.000
1150096	ONKA-9935	T BASKILI	0,91	400/20.000
1150097	ONKA-9936	U BASKILI	0,91	400/20.000
1150098	ONKA-9937	V BASKILI	0,91	400/20.000
1150099	ONKA-9938	W BASKILI	0,91	400/20.000
1150100	ONKA-9939	X BASKILI	0,91	400/20.000
1150101	ONKA-9940	Y BASKILI	0,91	400/20.000
1150102	ONKA-9941	Z BASKILI	0,91	400/20.000
1150087	ONKA-9926	Mp BASKILI	0,91	400/20.000
1150068	ONKA-9907	+ BASKILI	0,91	400/20.000
1150065	ONKA-9904	- BASKILI	0,91	400/20.000
1150095	ONKA-9934	± BASKILI	0,91	400/20.000
1150067	ONKA-9906	~ BASKILI	0,91	400/20.000
1150092	ONKA-9931	Q BASKILI	0,91	400/20.000
1150071	ONKA-9910	AC BASKILI	0,91	400/20.000

**NO:3 4,00 - 6,00 mm<sup>2</sup>**

ÜRÜN KODU	ESKİ KOD	BASKI	ADET (t)	KUTU / KOLİ ADEDİ
1150002	ONKA-9844	0 BASKILI	1,13	400/20.000
1150003	ONKA-9845	1 BASKILI	1,13	400/20.000
1150105	ONKA-9944	2 BASKILI	1,13	400/20.000
1150106	ONKA-9945	3 BASKILI	1,13	400/20.000
1150107	ONKA-9946	4 BASKILI	1,13	400/20.000
1150108	ONKA-9947	5 BASKILI	1,13	400/20.000
1150109	ONKA-9948	6 BASKILI	1,13	400/20.000
1150110	ONKA-9949	7 BASKILI	1,13	400/20.000
1150111	ONKA-9950	8 BASKILI	1,13	400/20.000
1150112	ONKA-9951	9 BASKILI	1,13	400/20.000
1150119	ONKA-9958	A BASKILI	1,13	400/20.000
1150120	ONKA-9959	B BASKILI	1,13	400/20.000
1150121	ONKA-9960	C BASKILI	1,13	400/20.000
1150122	ONKA-9961	D BASKILI	1,13	400/20.000
1150123	ONKA-9962	E BASKILI	1,13	400/20.000
1150124	ONKA-9963	F BASKILI	1,13	400/20.000
1150125	ONKA-9964	G BASKILI	1,13	400/20.000
1150126	ONKA-9965	H BASKILI	1,13	400/20.000
1150127	ONKA-9966	I BASKILI	1,13	400/20.000
1150128	ONKA-9967	J BASKILI	1,13	400/20.000
1150129	ONKA-9968	K BASKILI	1,13	400/20.000
1150130	ONKA-9969	L BASKILI	1,13	400/20.000
1150132	ONKA-9971	M BASKILI	1,13	400/20.000
1150133	ONKA-9972	N BASKILI	1,13	400/20.000
1150134	ONKA-9973	O BASKILI	1,13	400/20.000
1150135	ONKA-9974	P BASKILI	1,13	400/20.000
1150137	ONKA-9976	R BASKILI	1,13	400/20.000
1150138	ONKA-9977	S BASKILI	1,13	400/20.000
1150140	ONKA-9979	T BASKILI	1,13	400/20.000
1150141	ONKA-9980	U BASKILI	1,13	400/20.000
1150142	ONKA-9981	V BASKILI	1,13	400/20.000
1150143	ONKA-9982	W BASKILI	1,13	400/20.000
1150144	ONKA-9983	X BASKILI	1,13	400/20.000
1150145	ONKA-9984	Y BASKILI	1,13	400/20.000
1150146	ONKA-9985	Z BASKILI	1,13	400/20.000
1150131	ONKA-9970	Mp BASKILI	1,13	400/20.000
1150116	ONKA-9955	+ BASKILI	1,13	400/20.000
1150113	ONKA-9952	- BASKILI	1,13	400/20.000
1150139	ONKA-9978	± BASKILI	1,13	400/20.000
1150115	ONKA-9954	~ BASKILI	1,13	400/20.000
1150136	ONKA-9975	Q BASKILI	1,13	400/20.000
1150001	ONKA-9843	AC BASKILI	1,13	400/20.000

## PANO ETİKETLERİ (YAPIŞKANLI ve VİDALANABİLİR)



ÜRÜN KODU	CİNSİ	ADET (₺)	KUTU ADEDİ
ONKA-7114	17 x 30 mm	10,50	100
ONKA-7115	17 x 52 mm	11,40	100
ONKA-7116	17 x 70 mm	15,50	50

## METRELİK PANO ETİKETİ (YAPIŞKANLI)



ESKİ KOD	CİNSİ	ADET (€)	KUTU ADEDİ
ONKA-7126	15 x 1000 mm Yapışkanlı Pano Etiketi	4,20 €	50

## METRELİK PANO ETİKETİ (YAPIŞKANLI)

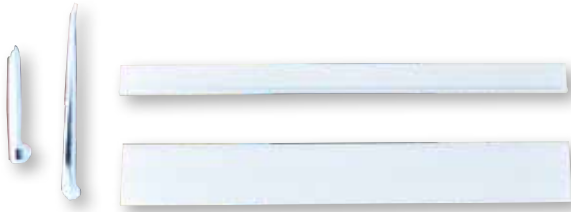

ÜRÜN KODU	CİNSİ	ADET (€)	KUTU ADEDİ
İRYPE-20200	20 x 2000 mm Yapışkanlı Pano Etiketi	3,20 €	200
İRYPE-30200	30 x 2000 mm Yapışkanlı Pano Etiketi	3,60 €	150
İRYPE-40200	40 x 2000 mm Yapışkanlı Pano Etiketi	3,70 €	120

## KABLolar İÇİN İŞARETLEME ETİKET YATAĞI



RENK	ÜRÜN KODU	CİNSİ	ADET (₺)	KUTU ADEDİ
→	ONKA-7134	2.5 - 3.6 mm Kablo bağları ile bağlanabilir. DB5 mm Klemens etiketleri kullanılabilir. Şeffaf daralan makoronla tam izolasyon yapılabilir.	9,25	100
→	ONKA-7135			
→	ONKA-7136			
→	ONKA-7137			
→	ONKA-7138			
→	ONKA-7139			



## KABLO BAĞI TUTUCULARI (YAPIŞKANLI ve VİDALI)

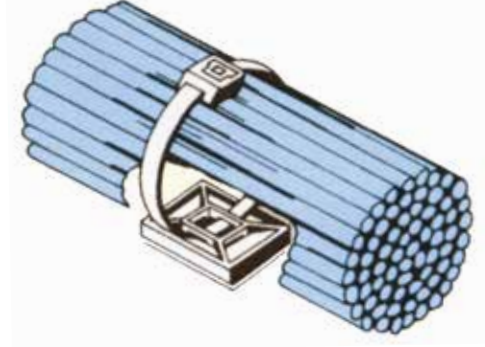
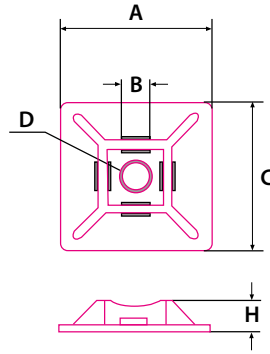

Bant Özelliği ; 1 mm Kalınlık - 120 °C ısı dayanımı - 96 kg/m<sup>3</sup> yoğunluk - max. 60 dk'da tam yapışkanlık.

ÜRÜN KODU	A	C	B	D	H	ADET (t)	KUTU ADEDİ
ONKA - 8391 / 3A	19	19	3.6	Ø3.2	4.0	2,16	100
ONKA - 8392 / 4A	28	28	4.8	Ø3.2	4.5	3,90	100

## ÇOK AMAÇLI BÜYÜK DURDURUCU

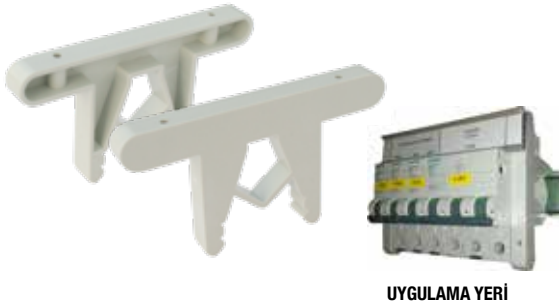

UYGULAMA YERİ

RENK	ÜRÜN KODU	CİNSİ	ADET (t)	KUTU ADEDİ
RAL 7035	İRPAY-1001	Çok Amaçlı Büyük Durdurucu	51,80	200

## W OTOMAT ÖRTME APARATI (12'Lİ)



RENK	ÜRÜN KODU	ESKİ KOD	CİNSİ	ADET (t)	KUTU ADEDİ
RAL 9001	1140021	ONKA-7121	W Otomat Örtme Aparatı	34,40	50
RAL 7035	1140022	ONKA-7122			
RAL 7032	1140024	ONKA-7124			

## W OTOMAT ÖRTME APARATI (2 METRE)



ÜRÜN KODU	RENK	CİNSİ	ADET (€)	KUTU ADEDİ
İRWCP9001	RAL 9001	2 mt. Örtü Plakası	3,60 €	60
İRWCP7035	RAL 7035		3,60 €	
İRWCP7032	RAL 7032		3,60 €	

## KABLO BAĞI ETİKET TAŞIYICI



ÜRÜN KODU	EN (mm)	BOY (mm)	CİNSİ	ADET (\$)	KUTU ADEDİ
ONKA-8560	33	12	Kablo Bağı Etiket Taşıyıcı	0,093 \$	100
ONKA-8561	44	19		0,184 \$	100

## PANO SİNYAL ve BUTON ETİKETLERİ



ÜRÜN KODU	CİNSİ	ADET (₺)	KUTU ADEDİ
İRPSET-3014	PANO SİNYAL ETİKETİ 30x14 mm	7,60	100
İRPSET-3015	PANO SİNYAL ETİKETİ 27x12 mm	9,40	100
İRPSET-3016	PANO SİNYAL ETİKETİ 27x18 mm	10,40	100
İRPSET-3017	PANO SİNYAL ETİKETİ 27x12 mm	8,60	100
İRPSET-2816	PANO SİNYAL ETİKETİ 28x16 mm	9,30	100



## KABLO RAKORLARI

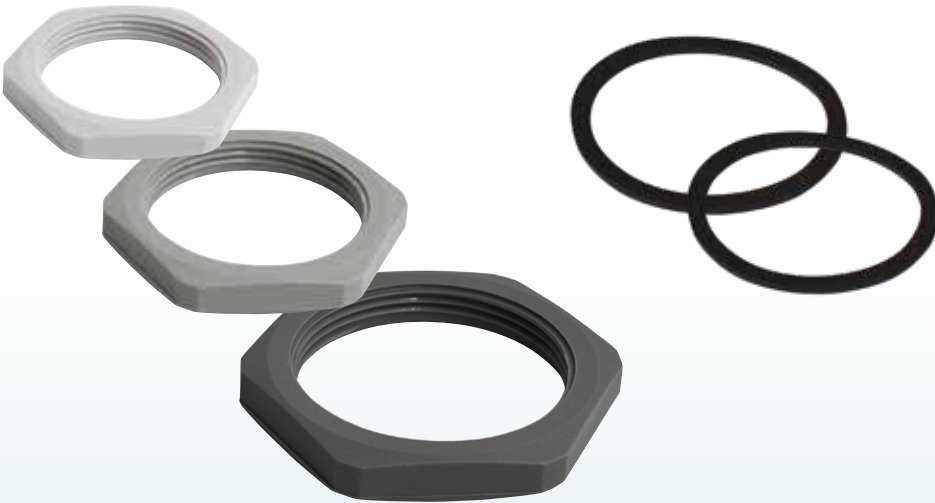

## PG POLYAMİD KABLO RAKORU (IP-68)

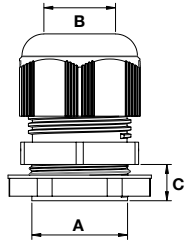

ORING



- Ral 7035
- Ral 7001
- Ral 9005

BOY	A (mm)	B (mm)	C (mm)	RENK (RAL)	ÜRÜN KODU	ESKİ KOD	ADET (t)	ÜRÜN KODU (Oringli)	ESKİ KOD (Oringli)	ADET (t) (Oringli)	KUTU ADEDİ
PG-7	12,5	3-6	7,8	7035	1110049	ONKA-9101	8,85	1110065	ONKA-9080	9,80	450
				7001	1110001	ONKA-9000		1110017	ONKA-9058		
				9005	1110096	ONKA-9102		1110112	ONKA-9123		
PG-9	15	4-8	8	7035	1110050	ONKA-9111	11,05	1110066	ONKA-9081	11,45	300
				7001	1110002	ONKA-9001		1110018	ONKA-9059		
				9005	1110097	ONKA-9112		1110113	ONKA-9124		
PG-11	18,4	5-10	8	7035	1110051	ONKA-9121	14,00	1110067	ONKA-9082	14,75	200
				7001	1110003	ONKA-9002		1110019	ONKA-9060		
				9005	1110098	ONKA-9122		1110114	ONKA-9125		
PG-13,5	20	6-12	10	7035	1110052	ONKA-9131	16,80	1110068	ONKA-9083	17,50	175
				7001	1110004	ONKA-9003		1110020	ONKA-9061		
				9005	1110099	ONKA-9132		1110115	ONKA-9126		
PG-16	22	10-14	10	7035	1110053	ONKA-9141	19,10	1110069	ONKA-9084	20,40	125
				7001	1110005	ONKA-9004		1110021	ONKA-9062		
				9005	1110100	ONKA-9142		1110116	ONKA-9127		
PG-21	28	13-18	11	7035	1110054	ONKA-9151	28,05	1110070	ONKA-9085	29,40	75
				7001	1110006	ONKA-9005		1110022	ONKA-9063		
				9005	1110101	ONKA-9152		1110117	ONKA-9128		
PG-29	37	18-25	11	7035	1110055	ONKA-9161	45,65	1110071	ONKA-9086	48,20	40
				7001	1110007	ONKA-9006		1110023	ONKA-9064		
				9005	1110102	ONKA-9162		1110118	ONKA-9129		
PG-36	47	22-32	16,9	7035	1110056	ONKA-9171	87,40	1110072	ONKA-9087	90,70	20
				7001	1110008	ONKA-9007		1110024	ONKA-9065		
				9005	1110103	ONKA-9172		1110119	ONKA-9130		
PG-42	54	32-38	13,6	7035	1110057	ONKA-9181	106,95	1110073	ONKA-9088	110,70	15
				7001	1110009	ONKA-9008		1110025	ONKA-9066		
				9005	1110104	ONKA-9182		1110120	ONKA-9133		
PG-48	60	37-44	13,6	7035	1110058	ONKA-9191	116,50	1110074	ONKA-9089	120,00	12
				7001	1110010	ONKA-9009		1110026	ONKA-9067		
				9005	1110105	ONKA-9192		1110121	ONKA-9134		

## METRİK POLYAMİD KABLO RAKORU (IP-68)

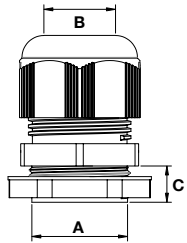

ORING

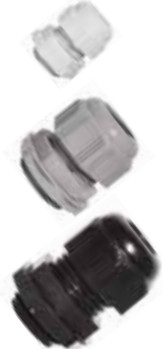

BOY	A (mm)	B (mm)	C (mm)	RENK (RAL)	ÜRÜN KODU	ESKİ KOD	ADET (t)	ÜRÜN KODU (Oringli)	ESKİ KOD (Oringli)	ADET (t) (Oringli)	KUTU ADEDİ
M12X1,5	12	3-6,5	6,2	7035	1110059	ONKA-9201	8,65	1110075	ONKA-9113	9,60	450
				7001	1110011	ONKA-9050		1110027	ONKA-9103		
				9005	1110106	ONKA-9202		1110122	ONKA-9135		
M16X1,5	16	5-10	8,3	7035	1110060	ONKA-9211	15,00	1110076	ONKA-9114	16,25	200
				7001	1110012	ONKA-9051		1110028	ONKA-9104		
				9005	1110107	ONKA-9212		1110123	ONKA-9136		
M20X1,5	20	6-12	9,6	7035	1110061	ONKA-9221	17,20	1110077	ONKA-9115	17,95	150
				7001	1110013	ONKA-9052		1110029	ONKA-9105		
				9005	1110108	ONKA-9222		1110124	ONKA-9137		
M25X1,5	25	13-18	10,5	7035	1110062	ONKA-9231	30,15	1110078	ONKA-9116	32,40	75
				7001	1110014	ONKA-9053		1110030	ONKA-9106		
				9005	1110109	ONKA-9232		1110125	ONKA-9138		
M32X1,5	32	18-25	15,8	7035	1110063	ONKA-9241	46,30	1110079	ONKA-9117	49,00	40
				7001	1110015	ONKA-9054		1110031	ONKA-9107		
				9005	1110110	ONKA-9242		1110126	ONKA-9139		
M40X1,5	40	24-32	12,5	7035	1110064	ONKA-9251	83,70	1110080	ONKA-9118	87,30	20
				7001	1110016	ONKA-9055		1110032	ONKA-9108		
				9005	1110111	ONKA-9252		1110127	ONKA-9140		

## PG SERİ POLYAMİD SOMUN

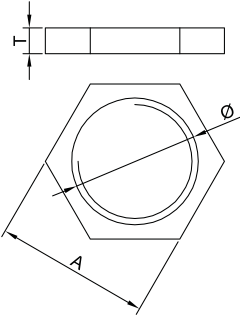

Ral 7035
  Ral 7001
  Ral 9005

BOY	Ø (mm)	A (mm)	T (mm)	RENK (RAL)	ÜRÜN KODU	ESKİ KOD	ADET (t)	KUTU ADEDİ
PG-7	12,5	19,0	5,0	7035 →	<b>1110081</b>	ONKA-9401	<b>1,55</b>	250
				7001 →	<b>1110033</b>	ONKA-9070		
				9005 →	<b>1110128</b>	ONKA-9402		
PG-9	15,5	22,0	5,0	7035 →	<b>1110082</b>	ONKA-9411	<b>1,60</b>	250
				7001 →	<b>1110034</b>	ONKA-9071		
				9005 →	<b>1110129</b>	ONKA-9412		
PG-11	18,5	24,0	5,0	7035 →	<b>1110083</b>	ONKA-9421	<b>2,20</b>	250
				7001 →	<b>1110035</b>	ONKA-9072		
				9005 →	<b>1110130</b>	ONKA-9422		
PG-13,5	20,5	27,0	6,0	7035 →	<b>1110084</b>	ONKA-9431	<b>2,60</b>	250
				7001 →	<b>1110036</b>	ONKA-9073		
				9005 →	<b>1110131</b>	ONKA-9432		
PG-16	22,5	30,0	6,0	7035 →	<b>1110085</b>	ONKA-9441	<b>2,65</b>	250
				7001 →	<b>1110037</b>	ONKA-9074		
				9005 →	<b>1110132</b>	ONKA-9442		
PG-21	28,5	36,0	7,0	7035 →	<b>1110086</b>	ONKA-9451	<b>3,50</b>	250
				7001 →	<b>1110038</b>	ONKA-9075		
				9005 →	<b>1110133</b>	ONKA-9452		
PG-29	37,5	46,0	7,0	7035 →	<b>1110087</b>	ONKA-9461	<b>5,65</b>	150
				7001 →	<b>1110039</b>	ONKA-9076		
				9005 →	<b>1110134</b>	ONKA-9462		
PG-36	47,0	60,0	7,3	7035 →	<b>1110088</b>	ONKA-9471	<b>12,60</b>	100
				7001 →	<b>1110040</b>	ONKA-9077		
				9005 →	<b>1110135</b>	ONKA-9472		
PG-42	55,0	65,0	7,4	7035 →	<b>1110199</b>	ONKA-2753	<b>15,50</b>	100
				7001 →	<b>1110041</b>	ONKA-9078		
				9005 →	<b>1110200</b>	ONKA-2754		
PG-48	60,0	70,0	7,8	7035 →	<b>1110089</b>	ONKA-5873	<b>16,50</b>	100
				7001 →	<b>1110042</b>	ONKA-9079		
				9005 →	<b>1110201</b>	ONKA-2755		

## METRİK SERİ POLYAMİD SOMUN

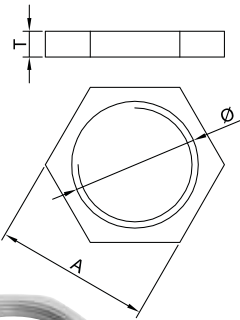

Ral 7035
  Ral 7001
  Ral 9005

BOY	Ø (mm)	A (mm)	T (mm)	RENK (RAL)	ÜRÜN KODU	ESKİ KOD	ADET (t)	KUTU ADEDİ
M12X1,5	12,0	19,0	5,0	7035 →	<b>1110090</b>	ONKA-9011	<b>1,45</b>	250
				7001 →	<b>1110043</b>	ONKA-9010		
				9005 →	<b>1110136</b>	ONKA-9012		
M16X1,5	16,0	22,0	5,0	7035 →	<b>1110091</b>	ONKA-9014	<b>2,10</b>	250
				7001 →	<b>1110044</b>	ONKA-9013		
				9005 →	<b>1110137</b>	ONKA-9015		
M20X1,5	20,0	26,0	5,0	7035 →	<b>1110092</b>	ONKA-9017	<b>2,55</b>	250
				7001 →	<b>1110045</b>	ONKA-9016		
				9005 →	<b>1110138</b>	ONKA-9019		
M25X1,5	25,0	32,0	6,0	7035 →	<b>1110093</b>	ONKA-9021	<b>3,35</b>	250
				7001 →	<b>1110046</b>	ONKA-9020		
				9005 →	<b>1110139</b>	ONKA-9022		
M32X1,5	32,0	42,0	7,0	7035 →	<b>1110094</b>	ONKA-9024	<b>6,55</b>	250
				7001 →	<b>1110047</b>	ONKA-9023		
				9005 →	<b>1110140</b>	ONKA-9025		
M40X1,5	40,0	50,0	7,0	7035 →	<b>1110095</b>	ONKA-9027	<b>8,40</b>	250
				7001 →	<b>1110048</b>	ONKA-9026		
				9005 →	<b>1110141</b>	ONKA-9028		

## PG SERİ SİRAL KABLO RAKORU

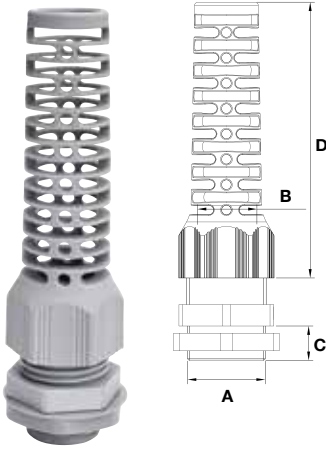

Ral 7035 Ral 7001 Ral 9005

BOY	A (mm)	B (mm)	C (mm)	D (mm)	RENK (RAL)	ÜRÜN KODU	ESKİ KOD	ADET (t)	KUTU ADEDİ
PG 7	12,5	3-6	7,8	46,5	7035 →	<b>1110152</b>	ONKA-9276	<b>12,15</b>	200
					7001 →	<b>1110142</b>	ONKA-9275		
					9005 →	<b>1110162</b>	ONKA-9277		
PG 11	18,4	5-10	8,0	68,0	7035 →	<b>1110154</b>	ONKA-9282	<b>18,35</b>	100
					7001 →	<b>1110144</b>	ONKA-9281		
					9005 →	<b>1110164</b>	ONKA-9283		
PG 13,5	20	6-12	10,0	77,0	7035 →	<b>1110155</b>	ONKA-9285	<b>21,75</b>	80
					7001 →	<b>1110145</b>	ONKA-9284		
					9005 →	<b>1110165</b>	ONKA-9286		
PG 21	28	13-18	11,0	107,0	7035 →	<b>1110157</b>	ONKA-9291	<b>42,15</b>	30
					7001 →	<b>1110147</b>	ONKA-9290		
					9005 →	<b>1110167</b>	ONKA-9292		

## METRİK SERİ SİRAL KABLO RAKORU

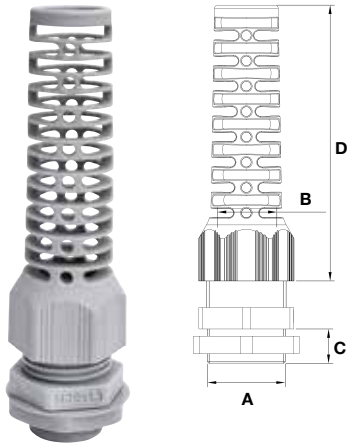

Ral 7035 Ral 7001 Ral 9005

BOY	A (mm)	B (mm)	C (mm)	D (mm)	RENK (RAL)	ÜRÜN KODU	ESKİ KOD	ADET (t)	KUTU ADEDİ
M12x1,5	12	3-6	6,2	46,5	7035 →	<b>1110158</b>	ONKA-9476	<b>12,00</b>	200
					7001 →	<b>1110148</b>	ONKA-9475		
					9005 →	<b>1110168</b>	ONKA-9477		
M16x1,5	16	5-10	8,3	68,0	7035 →	<b>1110159</b>	ONKA-9479	<b>18,30</b>	100
					7001 →	<b>1110149</b>	ONKA-9478		
					9005 →	<b>1110169</b>	ONKA-9480		
M20x1,5	20	6-12	9,7	77,0	7035 →	<b>1110160</b>	ONKA-9482	<b>20,60</b>	80
					7001 →	<b>1110150</b>	ONKA-9481		
					9005 →	<b>1110170</b>	ONKA-9483		
M25x1,5	25	13-18	10,5	107,0	7035 →	<b>1110161</b>	ONKA-9485	<b>42,70</b>	30
					7001 →	<b>1110151</b>	ONKA-9484		
					9005 →	<b>1110171</b>	ONKA-9486		

## ETANJ PİRİNÇ KABLO RAKOR NİKEL (SOMUNLU) (IP-68)



PG SERİ				UYGUN KABLO ÇAP (mm)	METRİK SERİ				KUTU ADEDİ
ÜRÜN KODU	BOY	MONTAJ ÇAP (mm)	ADET (t)		ÜRÜN KODU	BOY	MONTAJ ÇAP (mm)	ADET (t)	
REK.06.412	PG-7	12,5	☎	3 - 6,5	REK.06.012	M12x1,5	12	☎	50
REK.06.416	PG-9	15,5		4 - 8	REK.06.016	M16x1,5	16		50
REK.06.418	PG-11	19		5 - 10	REK.06.017	M16x1,5	16		50
REK.06.420	PG-13,5	20,5		6 - 12	REK.06.020	M20x1,5	20		50
REK.06.425	PG-16	22,5		10 - 14	REK.06.025	M25x1,5	25		50
REK.06.432	PG-21	28,5		13 - 18	REK.06.032	M32x1,5	32		25
REK.06.440	PG-29	37,5		18 - 25	REK.06.040	M40x1,5	40		20
REK.06.450	PG-36	47		22 - 32	REK.06.050	M50x1,5	50		10
REK.06.456	PG-42	55		30 - 38	REK.06.056	M56x1,5	56		10
REK.06.462	PG-48	60		30 - 38	REK.06.063	M63x1,5	63		10

## PLASTİK SİRALLER (SİYAH)



ÜRÜN KODU	ÇAP	ADET (t)	METRE
M-020 400014 00 11	Ø 14	⌚	100
M-020 400016 00 11	Ø 16		100
M-020 400018 00 11	Ø 18		50
M-020 400020 00 11	Ø 20		50
M-020 400026 00 11	Ø 26		50
M-020 400032 00 11	Ø 32		50
M-020 400040 00 11	Ø 40		25
M-020 400050 00 11	Ø 50		25

## POLYAMİD (PA6) SİRAL BORU

## POLİPROPİLEN (pp) SİRAL BORU



ÖLÇÜ (PA6)	ÖLÇÜ (PP)	RENK	İÇ ÇAP (mm)	DIŞ ÇAP (mm)	ADET (t)	METRE
PA7	PP7	Gri - Siyah	6,5	10,0	⌚	100
PA8,5	PP8,5	Gri - Siyah	8,5	12,0		100
PA10	PP10	Gri - Siyah	10,0	13,0		100
PA12	PP12	Gri - Siyah	12,0	16,0		50
PA14	PA14	Gri - Siyah	14,0	18,5		50
PA17	PP17	Gri - Siyah	17,0	21,5		50
PA19	PP19	Gri - Siyah	19,0	24,0		50
PA22	PP22	Gri - Siyah	22,0	27,5		50
PA23	PP23	Gri - Siyah	23,0	28,7		50
PA26	PP26	Gri - Siyah	26,0	31,0		25
PA29	PP29	Gri - Siyah	29,0	34,5		25
PA36	PP36	Gri - Siyah	36,0	42,5		25
PA48	PP48	Gri - Siyah	48,0	54,5		25

\*Siparişlerinizde Polyamid (PA6) veya Polipropilen (pp) taleplerinizi belirtiniz.

## POLYAMİD (PA6) SİRAL BORU RAKORU (Somunlu)

## GEÇMELİ TİP POLYAMİD SİRAL BORU RAKORU PG



ÖLÇÜ	RENK	UYGUN SİRAL	ADET (t)	KUTU ADEDİ
PG7	Gri - Siyah	PA8,5	⌚	50
PG9	Gri - Siyah	PA10		50
PG11	Gri - Siyah	PA12		50
PG13,5	Gri - Siyah	PA14		50
PG16	Gri - Siyah	PA17		50
PG21	Gri - Siyah	PA23		25
PG29	Gri - Siyah	PA29		20
M16x1,5	Gri - Siyah	PA12		50
M20x1,5	Gri - Siyah	PA17		50
M25x1,5	Gri - Siyah	PA23		25
M32x1,5	Gri - Siyah	PA29		20



ÖLÇÜ	RENK	UYGUN SİRAL	ADET (t)	KUTU ADEDİ
PG7	Gri - Siyah	PA8,5	⌚	100
PG9	Gri - Siyah	PA10		50
PG11	Gri - Siyah	PA12		50
PG13,5	Gri - Siyah	PA14		50
PG16	Gri - Siyah	PA17		50
PG21	Gri - Siyah	PA23		25
PG29	Gri - Siyah	PA29		25
PG36	Gri - Siyah	PA36		10
PG48	Gri - Siyah	PA48		10

\*Siparişlerinizde geçmeli veya somunlu taleplerinizi belirtiniz.

## GAMAK TİPİ ORJİNAL CAM ELYAFLI MOTOR KLEMENSİ



ÜRÜN KODU	RENK	TİP	BOY (mm)	EN (mm)	VİDA	ADET (t)	KUTU ADEDİ
OR - MKE 01	Kahverengi	56 - 63	40	25	M4	⌚	50
OR - MKE 02		71 - 80 - 90 - 100	50	30	M4		50
OR - MKE 03		132	60	37	M5		50
OR - MKE 04		160 - 180	72	44	M6		40
OR - MKE 05		225 - 250	91	56	M8		16
OR - MKE 06		280	115	70	M10		8

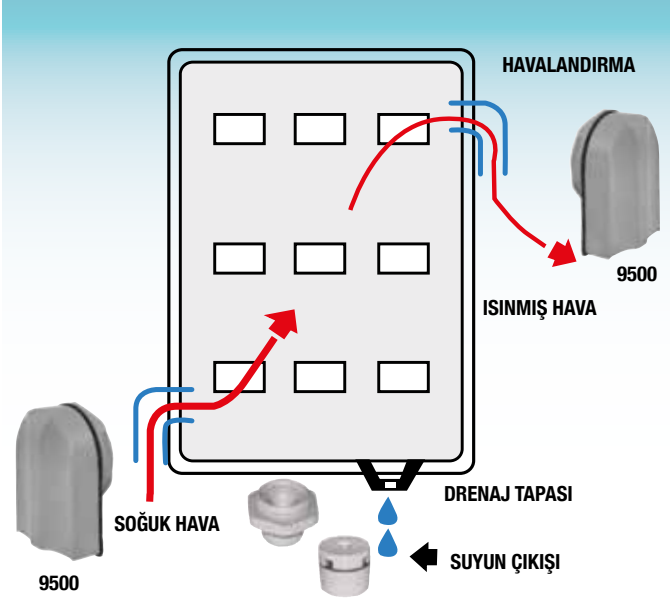

## PG POLYAMİD KÖRTAPA



BOY	MONTAJ ÇAPI	RENK (RAL)	ÜRÜN KODU	ESKİ KOD	ADET (t)	KUTU ADEDİ
PG-7	12,5	7035 →		ONKA-9301	Ⓢ	250
		7001 →		ONKA-9090		
		9005 →		ONKA-9302		
PG-9	15,5	7035 →		ONKA-9311	Ⓢ	250
		7001 →		ONKA-9091		
		9005 →		ONKA-9312		
PG-11	18,5	7035 →	<b>1110180</b>	ONKA-9321	<b>3,35</b>	250
		7001 →	<b>1110174</b>	ONKA-9092		
		9005 →	<b>1110186</b>	ONKA-9322		
PG-13,5	20,5	7035 →	<b>1110181</b>	ONKA-9331	<b>4,05</b>	250
		7001 →	<b>1110175</b>	ONKA-9093		
		9005 →	<b>1110187</b>	ONKA-9332		
PG-16	22,5	7035 →	<b>1110182</b>	ONKA-9341	<b>4,90</b>	250
		7001 →	<b>1110176</b>	ONKA-9094		
		9005 →	<b>1110188</b>	ONKA-9342		
PG-21	28,5	7035 →	<b>1110183</b>	ONKA-9351	<b>5,05</b>	250
		7001 →	<b>1110177</b>	ONKA-9095		
		9005 →	<b>1110189</b>	ONKA-9352		
PG-29	37,5	7035 →			Ⓢ	150
		7001 →		ONKA-9096		
		9005 →				
PG-36	47,5	7035 →			Ⓢ	100
		7001 →		ONKA-9097		
		9005 →				

## M40 x 1.5 PANO HAVALANDIRMA APARATI

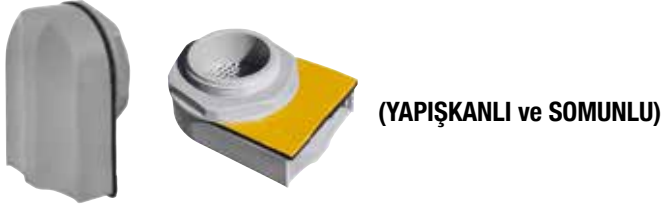

BOY	RENK (RAL)	ÜRÜN KODU	ESKİ KOD	ADET (t)	KUTU ADEDİ
M40 x 1,5	7035 →	<b>1110191</b>	ONKA-9501	<b>51,50</b>	50
	7001 →	<b>1110190</b>	ONKA-9500		
	9005 →	<b>1110192</b>	ONKA-9502		

## M25 x 1.5 DRENAJ TAPASI



BOY	RENK (RAL)	ÜRÜN KODU	ESKİ KOD	ADET (t)	KUTU ADEDİ
M25 x 1,5	7035 →	<b>1110194</b>	ONKA-9511	<b>11,45</b>	100
	7001 →	<b>1110193</b>	ONKA-9510		
	9005 →	<b>1110195</b>	ONKA-9512		

## Ø16 DRENAJ TAPASI



BOY	RENK (RAL)	ÜRÜN KODU	ESKİ KOD	ADET (t)	KUTU ADEDİ
Ø 16	7035 →	<b>1110197</b>	ONKA-9521	<b>12,85</b>	100
	7001 →	<b>1110196</b>	ONKA-9520		
	9005 →	<b>1110198</b>	ONKA-9522		

## KAUÇUK KÖRTAPA



ÜRÜN KODU	BOY	MONTAJ ÇAPI	ADET (t)	KUTU ADEDİ
<b>ONKA-9490</b>	PG-13.5	17	<b>9,00</b>	100
<b>ONKA-9491</b>	PG-16	22.8	<b>9,90</b>	100
<b>ONKA-9492</b>	PG-21	28.6	<b>12,30</b>	100
<b>ONKA-9493</b>	PG-29	37.3	<b>19,80</b>	100
<b>ONKA-9494</b>	PG-36	47	<b>48,30</b>	100
<b>ONKA-9495</b>	PG-42	55	<b>59,50</b>	50



# RAYA MONTAJ KAPAKLI PANO PRİZİ

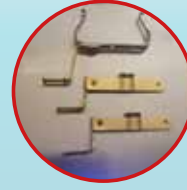

**PIRİNÇ METAL AĞIRLIK**  
**GR 14,20 GR**

**METAL MANDAL**

## RAYA MONTAJ KAPAKLI PANO PRİZİ (16 A / 250 V)



ÜRÜN KODU	AÇIKLAMA	ADET (t)	KUTU/KOLİ
ONKA - 7160	Tek Girişli LED'siz Topraklı	232,70	10 /120
ONKA - 7161	Çift Girişli LED'siz Topraklı	340,00	
ONKA - 7162	Tek Girişli LED'li Topraklı	300,00	
ONKA - 7163	Çift Girişli LED'li Topraklı	375,00	
ONKA - 7164	Tek Girişli LED'siz UPS'li	246,00	
ONKA - 7165	Çift Girişli LED'siz UPS'li	340,00	
ONKA - 7166	Tek Girişli LED'li UPS'li	265,00	
ONKA - 7167	Çift Girişli LED'li UPS'li	355,00	

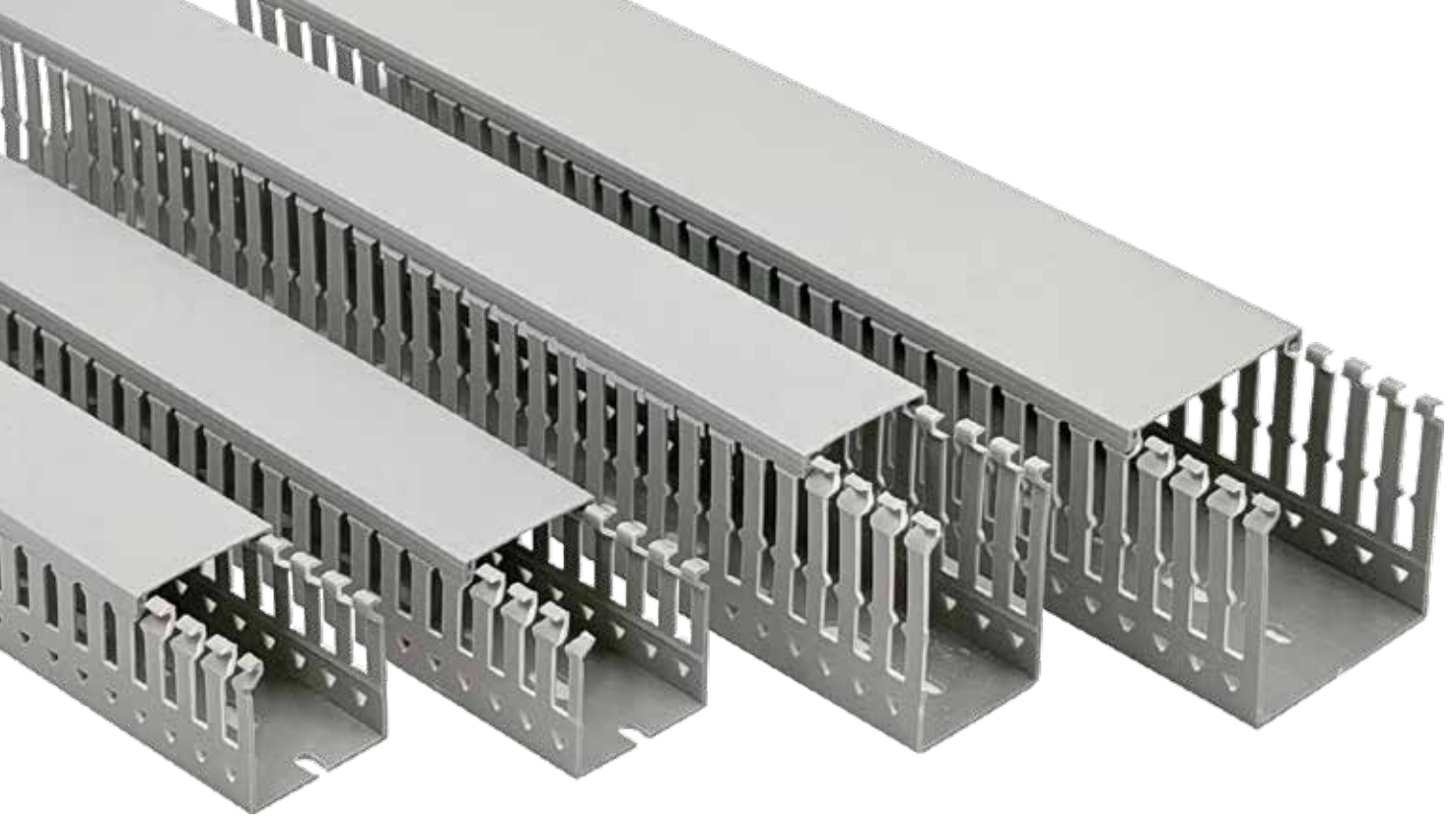

## KABLO KANALLARI (DELİKLİ)

# Onka®

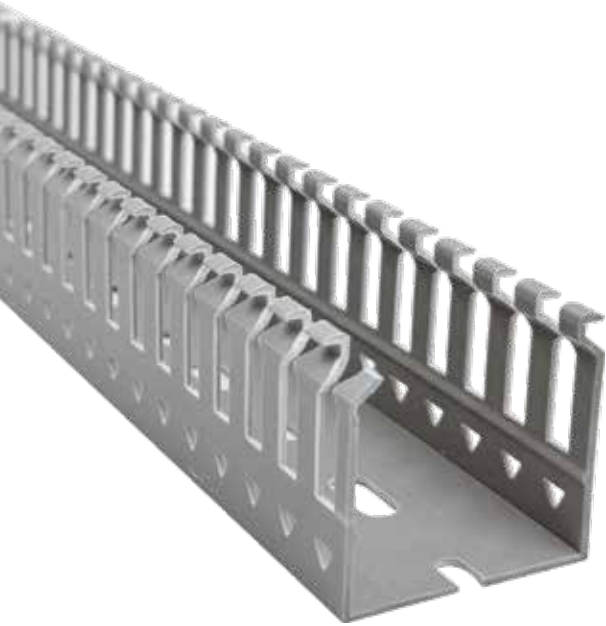

- Yüksek darbeye dayanıklı sert PVC malzeme
- -15 °C + 70 °C arası sıcaklık dayanımı
- UL94 V0 yanmazlık standardı
- Kolay kapanabilen kapak sistemi
- Yan tırnaklardaki kesikler sayesinde kolay kırılabilme imkanı
- 2 m standart boy
- 390 kg/cm gerilme gücü
- Renk RAL 7030 (Gri)

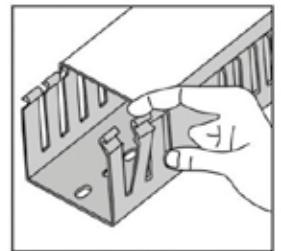
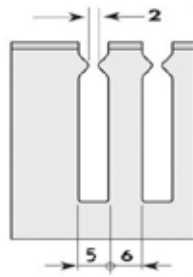

## PANO İÇİ DELİKLİ KABLO KANALI

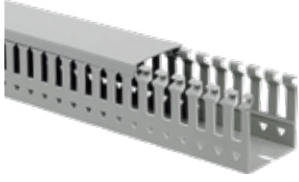

EBAT (Genişlik x Derinlik)	ÜRÜN KODU	METRE (₺)	HALOJEN FREE ÜRÜN KODU	HALOJEN FREE METRE (₺)	KUTU METRE
25 x 30 mm	CNL EN UL G 25 x 30	93,50	CNL EN HF G 25 x 30	Ⓢ	84
25 x 40 mm	CNL EN UL G 25 x 40	95,00	CNL EN HF G 25 x 40		84
25 x 60 mm	CNL EN UL G 25 x 60	124,50	CNL EN HF G 25 x 60		56
25 x 80 mm	CNL EN UL G 25 x 80	155,50	CNL EN HF G 25 x 80		48
40 x 40 mm	CNL EN UL G 40 x 40	141,50	CNL EN HF G 40 x 40		60
40 x 60 mm	CNL EN UL G 40 x 60	166,50	CNL EN HF G 40 x 60		36
40 x 80 mm	CNL EN UL G 40 x 80	184,50	CNL EN HF G 40 x 80		40
60 x 40 mm	CNL EN UL G 60 x 40	161,50	CNL EN HF G 60 x 40		40
60 x 60 mm	CNL EN UL G 60 x 60	194,00	CNL EN UL G 60 x 60		24
60 x 80 mm	CNL EN UL G 60 x 80	239,50	CNL EN HF G 60 x 80		24
80 x 60 mm	CNL EN UL G 80 x 60	231,00	CNL EN HF G 80 x 60		24
80 x 80 mm	CNL EN UL G 80 x 80	284,00	CNL EN HF G 80 x 80		24
100 x 60 mm	CNL EN UL G 100 x 60	300,00	CNL EN HF G 100 x 60		24

## DELİKLİ GRİ KABLO KANALI KAPAKLARI



EBAT	ÜRÜN KODU	METRE (₺)	HALOJEN FREE ÜRÜN KODU	HALOJEN FREE METRE (₺)	KUTU METRE
25 mm	CNL EN UL G 25	31,50	CNL EN HF G 25	Ⓢ	10x2m
40 mm	CNL EN UL G 40	49,50	CNL EN HF G 40		10x2m
60 mm	CNL EN UL G 60	66,50	CNL EN HF G 60		10x2m
80 mm	CNL EN UL G 80	102,50	CNL EN HF G 80		10x2m
100 mm	CNL EN UL G 100	142,50	CNL EN HF G 100		10x2m

# Onka®

## KABLO UÇLARI

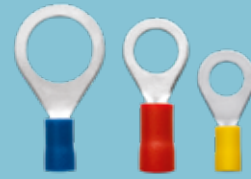
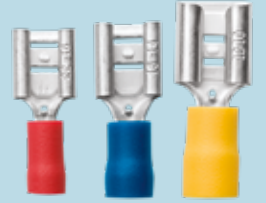
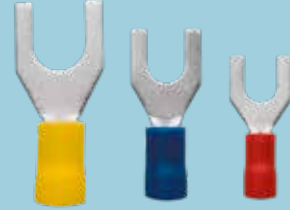

## KUTULU SERİ İZOLELİ TEK GİRİŞLİ KABLO YÜKSÜKLERİ DIN 46228 (-40 °C / 105 °C)

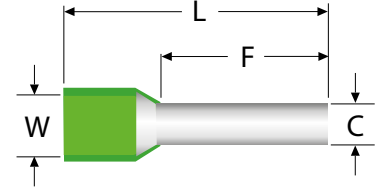

RENK NÖRMLERİ		
FRANSIZ	ALMAN	DIN

ÜRÜN KODU	KABLO KESİTİ (mm²)	F	L	C	W	ADET (\$)	KUTU ADEDİ
ST ONKA-8005	0,34	8,0	12,0	0,80	1,9	0,029	1.000
ONKA-8006	0,50	6,0	12,0	1,00	2,6	0,013	1.000
ST ONKA-8007	0,50	8,0	14,0	1,00	2,6	0,013	1.000
ONKA-8008	0,50	10,0	16,0	1,00	2,6	0,022	1.000
ONKA-8009	0,75	6,0	12,0	1,20	2,8	0,013	1.000
ST ONKA-8010	0,75	8,0	14,0	1,20	2,8	0,013	1.000
ONKA-8011	0,75	10,0	16,0	1,20	2,8	0,022	1.000
ONKA-8012	0,75	12,0	18,0	1,20	2,8	0,026	1.000
ONKA-8013	1,00	6,0	12,0	1,40	3,0	0,013	1.000
ST ONKA-8014	1,00	8,0	14,0	1,40	3,0	0,013	1.000
ONKA-8015	1,00	10,0	16,0	1,40	3,0	0,022	1.000
ONKA-8016	1,00	12,0	18,0	1,40	3,0	0,026	1.000
ST ONKA-8017	1,50	8,0	14,0	1,70	3,5	0,022	500
ONKA-8018	1,50	10,0	16,0	1,70	3,5	0,025	500
ONKA-8019	1,50	12,0	18,0	1,70	3,5	0,029	500
ONKA-8020	1,50	18,0	24,0	1,70	3,5	0,035	500
ST ONKA-8021	2,50	8,0	14,0	2,20	4,2	0,018	500
ONKA-8022	2,50	10,0	16,0	2,20	4,2	0,031	500
ONKA-8023	2,50	12,0	18,0	2,20	4,2	0,037	500
ONKA-8024	2,50	18,0	24,0	2,20	4,2	0,063	500
ST ONKA-8025	4,00	10,0	17,0	2,80	4,8	0,031	200
ONKA-8026	4,00	12,0	20,0	2,80	4,8	0,052	200
ONKA-8027	4,00	18,0	26,0	2,80	4,8	0,080	200
ST ONKA-8028	6,00	12,0	20,0	3,50	6,3	0,041	200
ONKA-8029	6,00	18,0	26,0	3,50	6,3	0,087	200
ST ONKA-8030	10	12,0	22,0	4,50	7,6	0,052	100
ONKA-8031	10	18,0	28,0	4,50	7,6	0,104	100
ST ONKA-8032	16	12,0	24,0	5,80	8,8	0,072	100
ONKA-8033	16	18,0	28,0	5,80	8,8	0,144	75
ST ONKA-8034	25	16,0	30,0	7,30	11,2	0,121	50
ONKA-8156	25	18,0	32,0	7,30	11,2	0,216	50
ONKA-8035	25	22,0	36,0	7,30	11,2	0,266	50
ST ONKA-8036	35	16,0	30,0	8,30	12,7	0,151	50
ONKA-8037	35	18,0	32,0	8,30	12,7	0,197	25
ONKA-8038	35	25,0	39,0	8,30	12,7	0,417	25
ST ONKA-8039	50	20,0	36,0	10,30	15,0	0,285	25
ONKA-8040	50	25,0	40,0	10,30	15,0	0,484	25
ST ONKA-8041	70	21,0	37,0	13,50	16,0	0,527	10
ST ONKA-8042	95	25,0	44,0	14,70	18,0	0,891	10
ST ONKA-8043	120	27,0	48,0	16,70	20,0	1,593	10
ST ONKA-8044	150	32,0	58,0	19,50	23,0	2,010	10

## KUTULU SERİ İZOLELİ ÇİFT GİRİŞLİ KABLO YÜKSÜKLERİ DIN 46228



- DIN 46228 Standardı,
- Bakır Malzemededen Kalay Kaplı,
- Polyamid İzoleli,
- -40 °C / + 105 °C Çalışma Sıcaklığı

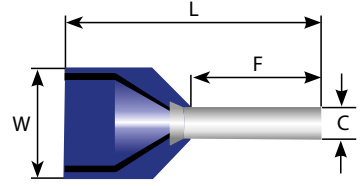
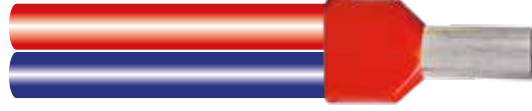

RENK NORMLARI		
FRANSIZ	ALMAN	DIN

	ÜRÜN KODU	KABLO KESİTİ (mm <sup>2</sup> )	F	L	C	W	ADET (\$)	KUTU ADEDİ
ST	ONKA-8161	2 x 0,50	8,0	15,0	1,5	2,5 / 4,7	0,023	500
	ONKA-8162	2 x 0,75	0,8	15,0	1,8	2,8 / 5,0	0,024	500
ST	ONKA-8163	2 x 0,75	10,0	17,0	1,8	2,8 / 5,0	0,040	500
	ONKA-8164	2 x 1,0	8,0	15,0	2,05	3,4 / 5,4	0,026	500
ST	ONKA-8165	2 x 1,0	10,0	17,0	2,05	3,4 / 5,4	0,042	500
	ONKA-8166	2 x 1,5	8,0	16,0	2,3	3,6 / 6,6	0,032	500
ST	ONKA-8528	2 x 1,5	10,0	16,0	2,3	3,6 / 6,6	0,051	500
	ONKA-8167	2 x 1,5	12,0	20,0	2,3	3,6 / 6,6	0,060	500
	ONKA-8168	2 x 2,5	10,0	18,5	2,8	4,2 / 7,8	0,050	250
ST	ONKA-8169	2 x 2,5	13,0	21,5	2,8	4,2 / 7,8	0,082	250
	ONKA-8170	2 x 4,0	12,0	23,0	3,7	4,9 / 8,8	0,058	100
ST	ONKA-8171	2 x 6,0	14,0	26,0	4,8	6,9 / 10,0	0,072	100
	ONKA-8172	2 x 10,0	14,0	26,5	6,4	7,6 / 12,8	0,111	50
ST	ONKA-8173	2 x 16,0	14,0	31,5	8,3	9,6 / 18,6	0,141	50

## KUTULU SERİ İZOLESİZ KABLO YÜKSÜKLERİ DIN 46228



DIN 46228 Standardı,  
Bakır Malzemededen Kalay Kaplı

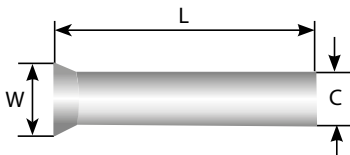

ÜRÜN KODU	KABLO KESİTİ (mm <sup>2</sup> )	L	C	W	ADET (\$)	KUTU ADEDİ
ONKA - 8102	0.50	10.0	1.0	2.1	0,014	1.000
ONKA - 8108	1.0	10.0	1.4	2.5	0,013	1.000
ONKA - 8112	1.5	10.0	1.7	2.8	0,015	1.000
ONKA - 8117	2.5	12.0	2.2	3.4	0,026	1.000
ONKA - 8121	4.0	12.0	2.8	4.0	0,027	1000
ONKA - 8125	6.0	12.0	3.5	4.7	0,037	500
ONKA - 8129	10.0	15.0	4.5	5.8	0,063	200
ONKA - 8132	16.0	15.0	5.8	7.5	0,078	100

## İZOLELİ YUVARLAK KABLO UÇLARI

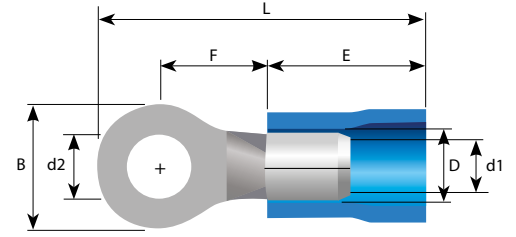

DIN 46237 Standardı, Bakır Malzemeden Kalay Kaplı, PVC İzoleli, 105 °C Çalışma Sıcaklığı, 600 Volt Çalışma Gerilimi

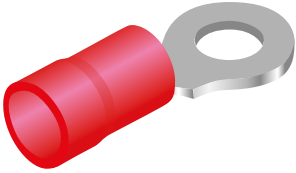

0,5 ~ 1,5 mm<sup>2</sup>, Kablo Kesiti

ÜRÜN KODU	METRİK ÖLÇÜ (d2)	B	L	F	E	D	d1	ADET (\$)	KUTU ADEDİ
ONKA-8045 -R1-3 V	3.2	5.5	16.7	4.0	10.0	4.1	1.7	0,073	200
ONKA-8047-R1-3.5 MV	3.7	6.6	19.6	6.3	10.0	4.1	1.7	0,082	200
ONKA-8049-R1-4 SV	4.3	6.6	19.6	6.3	10.0	4.1	1.7	0,078	200
ONKA-8050-R1-4 LV	4.3	8.0	21.0	7.0	10.0	4.1	1.7	0,097	200
ONKA-8051-R1-5 V	5.3	8.0	21.0	7.0	10.0	4.1	1.7	0,084	200
ONKA-8052-R1-6 V	6.5	11.6	26.8	11.1	10.0	4.1	1.7	0,107	200
ONKA-8053-R1-8 V	8.4	11.6	26.8	11.1	10.0	4.1	1.7	0,112	200
ONKA-8054-R1-10 V	10.5	13.6	30.7	13.9	10.0	4.1	1.7	0,203	100
ONKA-8055-R1-12 V	13	19.2	35.6	16.0	10.0	4.1	1.7	0,257	100

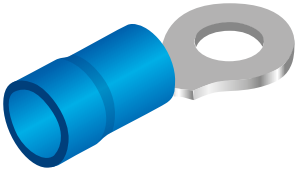

1,5 ~ 2,5 mm<sup>2</sup>, Kablo Kesiti

ONKA-8056-R2-3 V	3.2	6.4	17.5	4.3	10.0	4.5	2.3	0,084	200
ONKA-8058-R2-3.5 MV	3.7	6.6	19.5	6.3	10.0	4.5	2.3	0,111	200
ONKA-8059-R2-3.5 LV	3.7	8.5	22.0	7.8	10.0	4.5	2.3	0,111	200
ONKA-8060-R2-4 SV	4.3	6.6	19.5	6.3	10.0	4.5	2.3	0,093	200
ONKA-8086-R2-4 LV	4.3	8.5	22.0	7.8	10.0	4.5	2.3	0,115	200
ONKA-8087-R2-5 SV	5.3	8.5	22.0	7.8	10.0	4.5	2.3	0,090	200
ONKA-8088-R2-5 LV	5.3	9.5	22.0	7.3	10.0	4.5	2.3	0,115	200
ONKA-8089-R2-6 V	6.5	12.0	27.0	11.0	10.0	4.5	2.3	0,112	200
ONKA-8090-R2-8 V	8.4	12.0	27.0	11.0	10.0	4.5	2.3	0,129	200
ONKA-8091-R2-10 V	10.5	13.6	30.7	13.9	10.0	4.5	2.3	0,179	100
ONKA-8092-R2-12 V	13.0	19.2	35.6	16.0	10.0	4.5	2.3	0,331	100

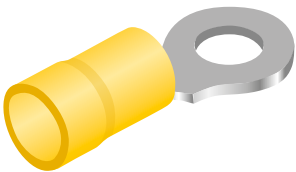

4,0 ~ 6,0 mm<sup>2</sup>, Kablo Kesiti

ONKA-8093-R5-4 SV	4.3	7.2	22.0	5.9	12.5	6.5	3.4	0,163	75
ONKA-8094-R5-4 LV	4.3	9.5	25.5	8.3	12.5	6.5	3.4	0,203	75
ONKA-8095-R5-5 V	5.3	9.5	25.5	8.3	12.5	6.5	3.4	0,179	75
ONKA-8096-R5-6 V	6.5	12.0	29.0	10.5	12.5	6.5	3.4	0,185	75
ONKA-8097-R5-8 V	8.4	15.0	33.7	13.7	12.5	6.5	3.4	0,226	75
ONKA-8098-R5-10 V	10.5	15.0	33.7	13.7	12.5	6.5	3.4	0,252	75
ONKA-8099-R5-12 V	13.0	19.2	38.1	16.0	12.5	6.5	3.4	0,286	75

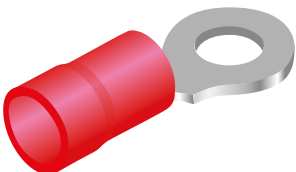

8.0 ~ 10.0 mm<sup>2</sup>, Kablo Kesiti

ONKA-8158-R8-4 LV	4.3	12.0	32.5	9.7	17.0	8.0	4.5	0,414	50
ONKA-8159-R8-5 MV	5.3	12.0	32.5	9.7	17.0	8.0	4.5	0,392	50
ONKA-8160-R8-6 SV	6.7	12.0	32.5	9.7	17.0	8.0	4.5	0,437	50
ONKA-8174-R8-5 LV	5.3	15.0	38.0	13.8	17.0	8.0	4.5	0,527	50
ONKA-8175-R8-6 LV	6.7	15.0	38.0	13.8	17.0	8.0	4.5	0,533	50
ONKA-8176-R8-8 V	8.4	15.0	38.0	13.8	17.0	8.0	4.5	0,485	50
ONKA-8177-R8-10 V	10.5	15.0	38.0	13.8	17.0	8.0	4.5	0,617	50

## İZOLELİ ÇATAL TİP KABLO UÇLARI

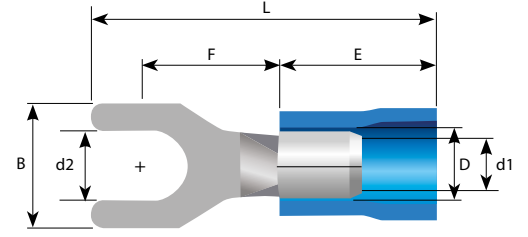

DIN 46237 Standardı, Bakır Malzemeden Kalay Kaplı, PVC İzoleli, 105 °C Çalışma Sıcaklığı, 600 Volt Çalışma Gerilimi

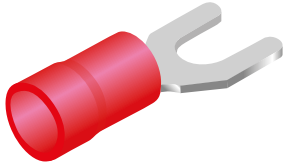

0,5 ~ 1,5 mm<sup>2</sup> , Kablo Kesiti

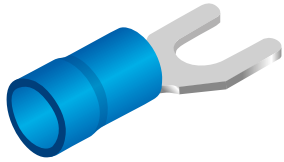

1,5 ~ 2,5 mm<sup>2</sup> , Kablo Kesiti

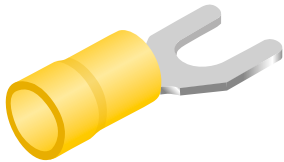

4,0 ~ 6,0 mm<sup>2</sup> , Kablo Kesiti

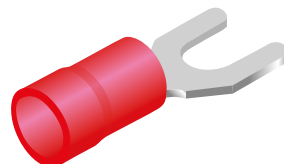

8,0 ~ 10,0 mm<sup>2</sup> , Kablo Kesiti

ÜRÜN KODU	METRİK ÖLÇÜ (d2)	B	L	F	E	D	d1	ADET (\$)	KUTU ADEDİ
ONKA - 8061-3 V	3.2	5.8	21.0	6.3	10.0	4.1	1.7	0,071	200
ONKA - 8062-3.5 SV	3.7	6.4	20.6	6.3	10.0	4.1	1.7	0,099	200
ONKA - 8063-3.5 LV	3.7	7.2	21.0	6.3	10.0	4.1	1.7	0,093	200
ONKA - 8064-4 SV	4.3	6.4	20.6	6.3	10.0	4.1	1.7	0,082	200
ONKA - 8065-4 MV	4.3	7.2	21.0	6.3	10.0	4.1	1.7	0,099	200
ONKA - 8066-5 SV	5.3	8.0	21.0	7.0	10.0	4.1	1.7	0,084	200
ONKA - 8067-5 LV	5.3	9.5	21.0	7.0	10.0	4.1	1.7	0,104	200
ONKA - 8068-6 LV	6.5	12.0	27.2	11.0	10.0	4.1	1.7	0,109	200
ONKA - 8069-8 V	8.4	12.0	27.2	11.0	10.0	4.1	1.7	0,178	100

ONKA - 8070-3 V	3.2	5.8	21.0	6.3	10.0	4.5	2.3	0,088	200
ONKA - 8071-3.5 MV	3.7	6.4	21.0	6.3	10.0	4.5	2.3	0,115	200
ONKA - 8072-4 SV	4.3	6.4	21.0	6.3	10.0	4.5	2.3	0,093	200
ONKA - 8073-4 MV	4.3	7.2	21.2	6.5	10.0	4.5	2.3	0,120	200
ONKA - 8074-5 LV	5.3	9.5	22.0	7.2	10.0	4.5	2.3	0,100	200
ONKA - 8075-6 LV	6.5	12.0	27.2	11.0	10.0	4.5	2.3	0,116	200
ONKA - 8076-8 V	8.4	12.0	27.2	11.0	10.0	4.5	2.3	0,194	100

ONKA - 8580 -3.5 SV	3.7	7.2	25.2	7.5	12.5	6.5	3.4	0,162	75
ONKA - 8077-4 SV	4.3	8.5	25.2	7.5	12.5	6.5	3.4	0,135	75
ONKA - 8078-4 LV	4.3	9.5	25.2	7.5	12.5	6.5	3.4	0,169	75
ONKA - 8079-5 V	5.3	9.5	25.2	7.5	12.5	6.5	3.4	0,144	75
ONKA - 8080-6 SV	6.5	9.5	25.2	7.5	12.5	6.5	3.4	0,188	75
ONKA - 8081-6 LV	6.5	12.0	31.2	12.0	12.5	6.5	3.4	0,193	75
ONKA - 8082-8V	8.4	13.5	30.0	10.5	12.5	6.5	3.4	0,214	75

ONKA - 8083-4V	4.3	8.2	29.0	8.1	17.0	8.0	4.5	0,459	50
ONKA - 8084-5V	5.3	9.0	29.0	8.1	17.0	8.0	4.5	0,473	50
ONKA - 8085-6V	6.5	10.8	30.5	8.6	17.0	8.0	4.5	0,493	50

S: Small

M: Medium

L: Large



## PVC İZOLELİ FASTON DİŞİ KABLO UCU



Pirinç Malzemededen Kalay Kaplı,  
PVC İzoleli,  
75 °C Çalışma Sıcaklığı,  
300 Volt Çalışma Gerilimi

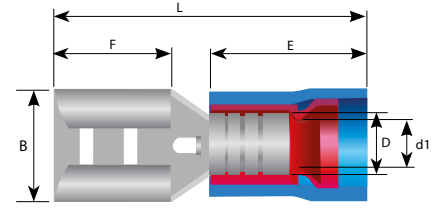

### EXTRA ÇİFT YÜKSÜKLÜ

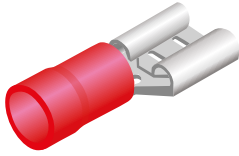

0,5 ~ 1,5 mm<sup>2</sup>, Kablo Kesiti

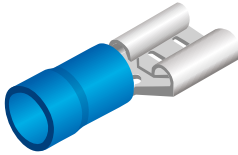

1,5 ~ 2,5 mm<sup>2</sup>, Kablo Kesiti

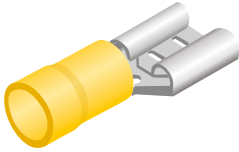

4,0 ~ 6,0 mm<sup>2</sup>, Kablo Kesiti

ÜRÜN KODU	SOKET GENİŞLİĞİ	B	F	L	E	D	d1	ADET (\$)	KUTU ADEDİ
ONKA - 8230-F1-2.8 VD/5	0.5 x 2.8	3.2	6.4	18.5	10.0	4.3	1.7	0,101	200
ONKA - 8231-F1-2.8 VD/8	0.8 x 2.8	3.2	6.4	18.5	10.0	4.3	1.7	0,099	200
ONKA - 8232-F1-4.8 VD/5	0.5 x 4.8	5.0	6.5	19.0	10.0	4.3	1.7	0,107	200
ONKA - 8233-F1-4.8 VD/8	0.8 x 4.8	5.0	6.5	19.0	10.0	4.3	1.7	0,107	200
ONKA - 8234-F1-6.4 VD	0.8 x 6.4	6.6	7.9	21.0	10.0	4.3	1.7	0,131	200
ONKA - 8235-F1-8 VD	0.8 x 8.0	8.4	10.0	24.0	10.0	4.3	1.7	0,203	200
ONKA - 8236-F2-2.8 VD/5	0.5 x 2.8	3.2	6.4	18.5	10.0	5.0	2.3	0,112	150
ONKA - 8237-F2-2.8 VD/8	0.8 x 2.8	3.2	6.4	18.5	10.0	5.0	2.3	0,101	150
ONKA - 8238-F2-4.8 VD/5	0.5 x 4.8	5.0	6.5	19.0	10.0	5.0	2.3	0,135	150
ONKA - 8239-F2-4.8 VD/8	0.8 x 4.8	5.0	6.5	19.0	10.0	5.0	2.3	0,101	150
ONKA - 8240-F2-6.4 VD	0.8 x 6.4	6.6	7.9	21.0	10.0	5.0	2.3	0,140	150
ONKA - 8241 -F2-8 VD	0.8 x 8.0	8.4	10.0	24.0	10.0	5.0	2.3	0,216	150
ONKA - 8242-F2-9.5 VD	1.2 x 9.5	9.5	12.5	29.0	10.0	5.0	2.3	0,338	150
ONKA - 8243-F5-6.4 VD	0.8 x 6.4	6.6	7.9	23.5	12.5	6.5	3.4	0,146	100
ONKA - 8244-F5-9.5VD	1.2 x 9.5	9.9	12.5	28.5	12.5	6.5	3.4	0,290	100

## İZOLELİ EKSTRA ÇİFT YÜKSÜKLÜ ERKEK KABLO UCU



Pirinç malzemededen kalay kaplı,  
PVC izoleli,  
75 °C çalışma sıcaklığı,  
300 Volt Çalışma Gerilimi

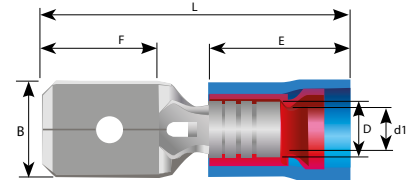

ÜRÜN KODU	KABLO KESİTİ (mm <sup>2</sup> )	SOKET GENİŞLİĞİ	ÖLÇÜLER (mm)						ADET (\$)	KUTU ADEDİ
			B	F	L	E	D	d1		
ONKA-8264-M1 - 2.8 VD/5	0.5~1.5 mm 22~16 AWG	0.5 x 2.8	2.8	7.0	19.2	10.0	4.3	1.7	0,113	200
ONKA-8265-M1 - 2.8 VD/8		0.8 x 2.8	2.8	7.8	20.5				0,098	200
ONKA-8266-M1 - 4.8 VD/5		0.5 x 4.8	4.8	7.0	19.2				0,131	200
ONKA-8267-M1 - 4.8 VD/8		0.8 x 4.8	4.8	7.8	20.5				0,112	200
ONKA-8268-M1 - 6.4 VD		0.8 x 6.4	6.4	7.8	21.2				0,129	200
ONKA-8269-M2 - 2.8 VD/5	1.5~2.5 mm 16~14 AWG	0.5 x 2.8	2.8	7.0	19.2	10.0	5.0	2.3	0,122	200
ONKA-8270-M2 - 2.8 VD/8		0.8 x 2.8	2.8	7.8	20.5				0,112	200
ONKA-8271-M2 - 4.8 VD/5		0.5 x 4.8	4.8	7.0	19.2				0,122	200
ONKA-8272-M2 - 4.8 VD/8		0.8 x 4.8	4.8	7.8	20.5				0,120	200
ONKA-8273-M2 - 6.4 VD		0.8 x 6.4	6.4	7.8	21.2				0,129	200
ONKA-8274-M5 - 6.4 VD	4.0~6.0 mm 12~10 AWG	0.8 x 6.4	6.4	7.8	23.7	12.5	6.5	3.4	0,204	100

## PVC FULL İZOLELİ FASTON DİŞİ KABLO UCU



### EXTRA ÇİFT YÜKSÜKLÜ

Pirinç Malzemeden Kalay Kaplı,  
PVC İzoleli,  
75 °C Çalışma Sıcaklığı,  
300 Volt Çalışma Gerilimi

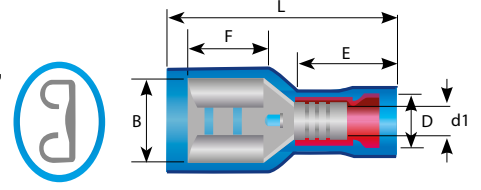

0,5 ~ 1,5 mm<sup>2</sup>, Kablo Kesiti

ÜRÜN KODU	SOKET GENİŞLİĞİ	B	F	L	E	D	d1	ADET (\$)	KUTU ADEDİ
ONKA - 8250-F1-2.8 VFD-5	0.5 x 2.8	3.2	6.4	19.0	10.0	4.3	1.7	<b>0,123</b>	200
ONKA - 8251-F1-2.8 VFD-8	0.8 x 2.8	3.2	6.4	19.0	10.0	4.3	1.7	<b>0,118</b>	200
ONKA - 8252-F1-4.8 VFD-5	0.5 x 4.8	5.0	6.5	20.0	10.0	4.3	1.7	<b>0,123</b>	200
ONKA - 8253-F1-4.8 VFD-8	0.8 x 4.8	5.0	6.5	20.0	10.0	4.3	1.7	<b>0,118</b>	200
ONKA - 8254-F1-6.4 VFD	0.8 x 6.4	6.6	7.9	22.0	10.0	4.3	1.7	<b>0,155</b>	100

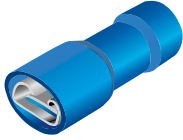

1,5 ~ 2,5 mm<sup>2</sup>, Kablo Kesiti

ONKA - 8255-F2-2.8 VFD-5	0.5 x 2.8	3.2	6.4	19.0	10.0	5.0	2.3	<b>0,135</b>	100
ONKA - 8256-F2-2.8 VFD-8	0.8 x 2.8	3.2	6.4	19.0	10.0	5.0	2.3	<b>0,129</b>	100
ONKA - 8257-F2-4.8 VFD-5	0.5 x 4.8	5.0	6.5	20.0	10.0	5.0	2.3	<b>0,135</b>	100
ONKA - 8258-F2-4.8 VFD-8	0.8 x 4.8	5.0	6.5	20.0	10.0	5.0	2.3	<b>0,129</b>	100
ONKA - 8259-F2-6.4 VFD	0.8 x 6.4	6.6	7.9	22.0	10.0	5.0	2.3	<b>0,155</b>	100

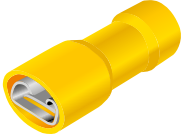

4,0 ~ 6,0 mm<sup>2</sup>, Kablo Kesiti

ONKA - 8260-F5-6.4 VFD	0.8 x 6.4	6.6	7.9	25.0	13.0	6.5	3.4	<b>0,185</b>	75
------------------------	-----------	-----	-----	------	------	-----	-----	--------------	----

## POLYAMİD FULL İZOLELİ DİŞİ FASTON KABLO UCU

Pirinç malzemeden kalay kaplı,  
polyamid izoleli,  
105 °C çalışma sıcaklığı,  
300 Volt Çalışma Gerilimi

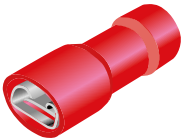
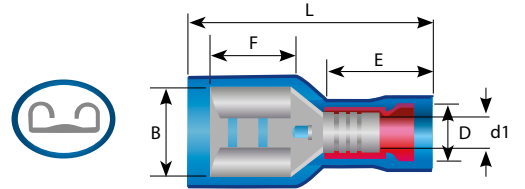

ÜRÜN KODU	KABLO KESİTİ (mm <sup>2</sup> )	SOKET GENİŞLİĞİ	ÖLÇÜLER (mm)						ADET (\$)	KUTU ADEDİ
			B	F	L	E	D	d1		
ONKA - 8529- F1 - 2.8 AFC	0.5 ~ 1.5 mm 22 ~ 16 AWG	0.8 x 2.8	2.8	19.0	10.5	4.2	1.7	1.7	<b>0,203</b>	100
ONKA - 8261- F1 - 6.4 AFC		0.8 x 6.4	6.4	22.0	10.5	4.2	1.7	1.7	<b>0,224</b>	100

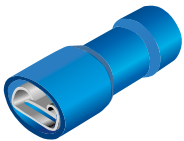

ONKA - 8262- F2 - 6.4 AFC	1.5 ~ 2.5 mm 16 ~ 14 AWG	0.8 x 6.4	6.4	7.9	22.0	10.5	4.9	2.3	<b>0,224</b>	100
---------------------------	-----------------------------	-----------	-----	-----	------	------	-----	-----	--------------	-----

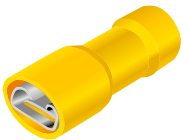

ONKA - 8263- F5 - 6.4 AFC	4.0 ~ 6.0 mm 12 ~ 10 AWG	0.8 x 6.4	6.4	24.5	13.0	6.5	3.4	3.4	<b>0,295</b>	100
---------------------------	-----------------------------	-----------	-----	------	------	-----	-----	-----	--------------	-----

## PVC İZOLELİ FASTON ERKEK / DİŞİ GERİ DÖNÜŞLÜ KABLO UCU



Pirinç Malzemedden Kalay Kaplı,  
PVC İzoleli,  
75 °C Çalışma Sıcaklığı,  
600 Volt Çalışma Gerilimi

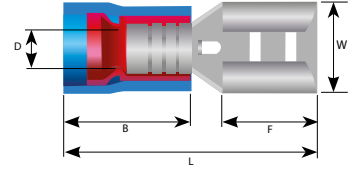
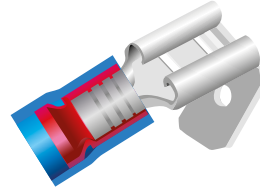

0,5 ~ 1,5 mm<sup>2</sup>, Kablo Kesiti

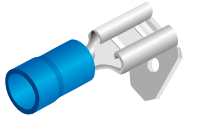

1,5 ~ 2,5 mm<sup>2</sup>, Kablo Kesiti

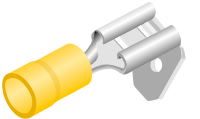

4,0 ~ 6,0 mm<sup>2</sup>, Kablo Kesiti

ÜRÜN KODU	SOKET GENİŞLİĞİ	W	F	L	B	D	ADET (\$)	KUTU ADEDİ
ONKA - 8280-PB1-6.4 VD	0.8 x 6.35	6.6	6.35	8.0	8.2	3.8	0,203	100
ONKA - 8281-PB2-6.4 VD	0.8 x 6.35	6.6	6.35	8.0	10.0	4.7	0,204	100
ONKA - 8282-PB5 -6.4 VD	0.8 x 6.35	6.6	6.35	8.0	8.2	6.2	0,252	100

## İZOLELİ BAYRAK TİP KABLO UCU



Pirinç Malzemedden Kalay Kaplı, PVC İzoleli,  
105 °C Çalışma Sıcaklığı,  
300 Volt Çalışma Gerilimi

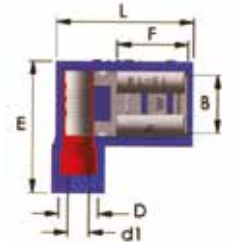

ÜRÜN KODU	KABLO KESİTİ	RENK	SOKET GENİŞLİĞİ	B	L	F	E	D	d1	ADET (\$)	KUTU ADEDİ
ONKA-8225-FL1-6.4AC	0,5 - 1,5 mm <sup>2</sup>	Kırmızı	0.8 x 6.4	6.6	7.9	16.1	15.0	4.5	1.7	0,168	100
ONKA-8226-FL2-6.4AC	1,5- 2,5 mm <sup>2</sup>	Mavi	0.8 x 6.4	6.6	7.9	16.1	15.0	4.5	1.7	0,189	100

## İZOLELİ EK MUFLAR



Pirinç Malzemedden  
Kalay Kaplı, PVC İzoleli,  
75 °C Çalışma Sıcaklığı,  
300 Volt Çalışma Gerilimi



ÜRÜN KODU	KABLO KESİTİ (mm <sup>2</sup> )	L	d	D	ADET (\$)	KUTU ADEDİ
ONKA-8215-BB 1V	0,5 - 1,5	26.0	1.7	4.1	0,120	100
ONKA-8216-BB 2V	1,5 - 2,5	26.0	2.3	4.5	0,129	100
ONKA-8217-BB 5V	4,0 - 6,0	27.0	3.4	6.5	0,224	100

## İĞNE TİP PVC İZOLELİ KABLO UÇLARI

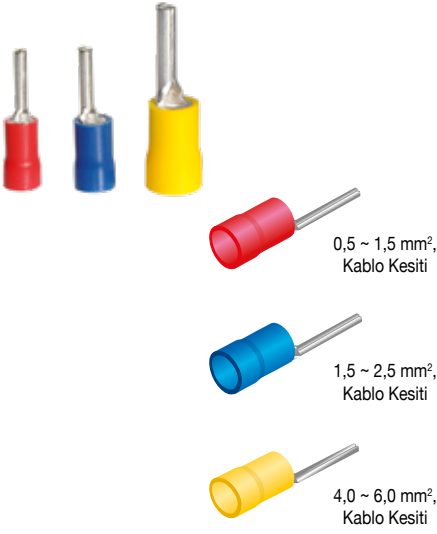

Bakır malzemeden, kalay kaplı, PVC izoleli,  
75 °C çalışma sıcaklığı,  
600 Volt Çalışma Gerilimi

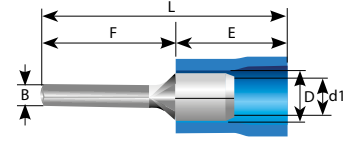

ÜRÜN KODU	B	L	F	E	D	d1	ADET (\$)	KUTU ADEDİ
ONKA-8186-PT1-10V	1.9	20.5	10.5	10.0	4.1	1.7	0,064	200
ONKA-8187-PT2-10V	1.9	20.5	10.5	10.0	4.5	2.3	0,077	200
ONKA-8188-PT2-12V	1.9	22.5	12.5	10.0	4.5	2.3	0,093	200
ONKA-8189-PT2-18V	1.9	28.5	18.5	10.0	4.5	2.3	0,153	100
ONKA-8190-PT5-13V	2.8	26.2	13.7	12.5	6.5	3.4	0,181	100

## BIÇAK TİP PVC İZOLELİ KABLO UÇLARI

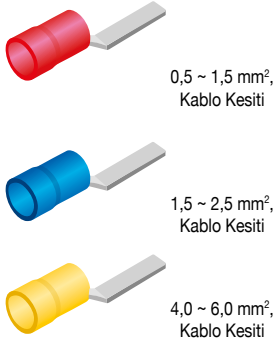

Bakır malzemeden kalay kaplı, Naylon izoleli,  
105 °C çalışma sıcaklığı,  
600 Volt Çalışma Gerilimi

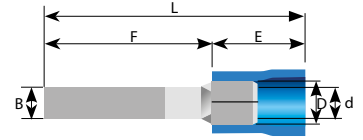

ÜRÜN KODU	B	L	F	E	D	d1	ADET (\$)	KUTU ADEDİ
ONKA-8191-BT1-10A	2.4	21.5	10.5	11.0	4.1	1.7	0,161	100
ONKA-8192-BT1-14A	3.0	22.0	11.0	11.0	4.1	1.7	0,169	100
ONKA-8193-BT1-18A	3.0	25.0	14.0	11.0	4.1	1.7	0,148	100
ONKA-8194-BT2-9A	2.8	20.0	9.0	11.0	4.5	2.3	0,186	100
ONKA-8195-BT2-18A	2.4	29.0	18.0	11.0	4.5	2.3	0,183	100
ONKA-8196-BT5-18A	3.0	31.0	18.0	13.0	6.5	3.4	0,355	100

## UCU KIVRIK İZOLELİ BIÇAK TERMİNALER

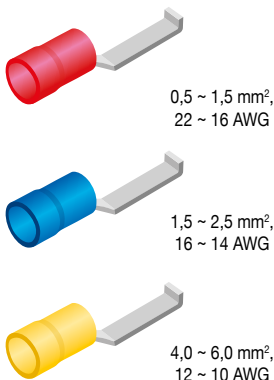

Bakır malzemeden kalay kaplı, Naylon izoleli,  
105 °C çalışma sıcaklığı,  
600 Volt Çalışma Gerilimi

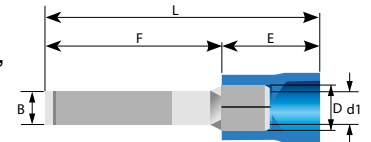

ÜRÜN KODU	B	F	L	E	D	d1	ADET (\$)	KUTU ADEDİ
ONKA-LB1-3V	3.0	18.0	29.0	11.0	4.1	1.7	0,232	200
ONKA-LB1-4.6V	4.6	18.0	29.0	11.0	4.1	1.7	0,265	200
ONKA-LB2-3V	3.0	18.0	29.0	11.0	4.5	2.3	0,317	100
ONKA-LB2-4.6V	4.6	18.0	29.0	11.0	4.5	2.3	0,376	100
ONKA-LB5-3V	3.0	17.5	30.5	13.0	6.5	3.4	0,487	100
ONKA-LB5-4.6V	4.6	17.5	30.5	13.0	6.5	3.4	0,540	100

## TAM İZOLELİ ERKEK TERMİNAL & T BAĞLANTI TERMİNALİ

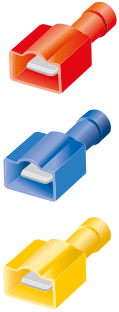
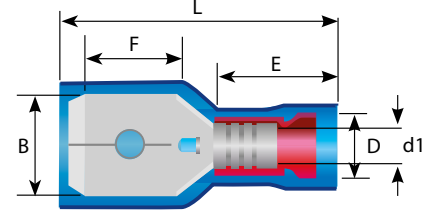
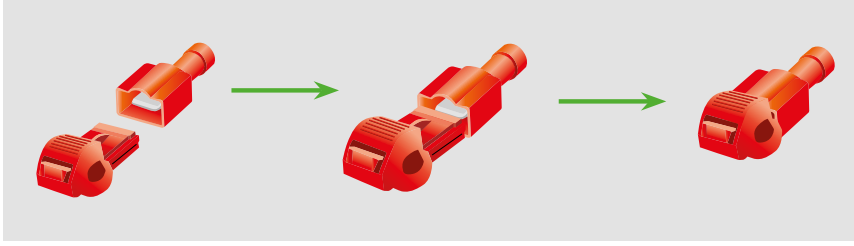

ÜRÜN KODU	KABLO KESİTİ (mm <sup>2</sup> )	B	F	L	E	D	d1	ADET (\$)	KUTU ADEDİ
ONKA-M1-6.4AFC	0.5 ~ 1.5 mm 22 ~ 16 AWG	6.35	7.9	23.5	10.5	4.2	1.7	0,230	100
ONKA-M2-6.4AFC	1.5 ~ 2.5 mm 16 ~ 14 AWG	6.35	7.9	23.5	10.5	4.9	2.3	0,243	100
ONKA-M5-6.4AFC	4.0 ~ 6.0 mm 12 ~ 10 AWG	6.35	7.9	27.0	13.0	6.5	3.4	0,351	100

## ÇENGEL İZOLELİ KABLO UCU

### EXTRA ÇİFT YÜKSÜKLÜ

Pirinç Malzemeden Kalay Kaplı, PVC İzoleli,  
75 °C Çalışma Sıcaklığı,  
300 Volt Çalışma Gerilimi

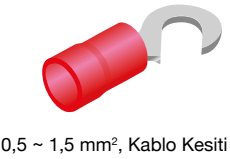
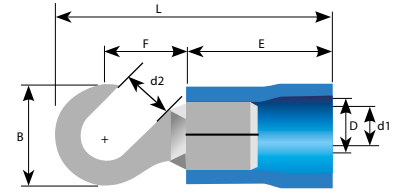

ÜRÜN KODU	METRİK ÖLÇÜ (d2)	B	L	F	E	D	d1	ADET (\$)	KUTU ADEDİ
ONKA - 8290-H1-4V	4.3	8.0	21.0	7.0	10.0	4.1	1.7	0,128	200
ONKA - 8291-H1-5V	5.3	8.0	21.0	7.0	10.0	4.1	1.7	0,142	200
ONKA - 8292-H1-6V	6.5	11.6	26.8	11.1	10.0	4.1	1.7	0,189	200

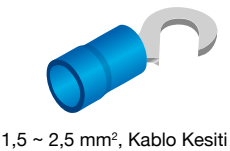

ONKA - 8293-H2-4V	4.3	8.5	22.0	7.8	10.0	4.5	2.3	0,162	200
ONKA - 8294-H2-5V	5.3	9.5	22.0	7.3	10.0	4.5	2.3	0,169	200
ONKA - 8295-H2-6V	6.5	12.0	27.0	11.0	10.0	4.5	2.3	0,203	200



ONKA - 8296-H5-4V	4.3	9.5	25.5	8.3	12.5	6.5	3.4	0,196	100
ONKA - 8297-H5-5V	5.3	9.5	25.0	8.3	12.5	6.5	3.4	0,216	100
ONKA - 8298-H5-6V	6.5	12.0	29.0	10.5	12.5	6.5	3.4	0,223	100

## İZOLELİ KURŞUN ERKEK KABLO UCU



0,5 ~ 1,5 mm<sup>2</sup>, Kablo Kesiti

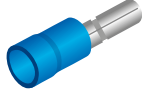

1,5 ~ 2,5 mm<sup>2</sup>, Kablo Kesiti



4,0 ~ 6,0 mm<sup>2</sup>, Kablo Kesiti

Bakır malzemeden, kalay kaplı, PVC izoleli,  
75 °C çalışma sıcaklığı,  
600 Volt Çalışma Gerilimi

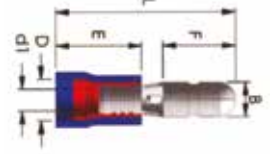

ÜRÜN KODU	B	F	L	E	D	d1	ADET (\$)	KUTU ADEDİ
ONKA-8200-BD1-4VD	4.0	8.5	21.0	10.0	4.3	1.7	0,140	200
ONKA-8201-BD2-4VD	4.0	8.5	21.0	10.0	4.3	2.3	0,134	200
ONKA-8202-BD2-5VD	5.0	8.5	21.0	10.0	5.0	2.3	0,185	200
ONKA-8203-BD5-5VD	5.0	8.5	23.5	13.0	6.5	3.4	0,213	100

## TAM İZOLELİ KURŞUN DIŞI KABLO UCU



0,5 ~ 1,5 mm<sup>2</sup>, Kablo Kesiti



1,5 ~ 2,5 mm<sup>2</sup>, Kablo Kesiti



4,0 ~ 6,0 mm<sup>2</sup>, Kablo Kesiti

Bakır malzemeden, kalay kaplı, PVC izoleli,  
75 °C çalışma sıcaklığı,  
300 Volt Çalışma Gerilimi

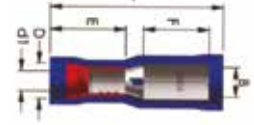

ÜRÜN KODU	B	F	L	E	D	d1	ADET (\$)	KUTU ADEDİ
ONKA-8210-RE1-4VFD	4.0	9.0	23.5	11.0	4.3	1.7	0,167	100
ONKA-8211-RE2-4VFD	4.0	9.0	23.5	11.0	5.0	2.3	0,190	100
ONKA-8212-RE2-5VFD	5.0	9.0	23.5	11.0	5.0	2.3	0,210	100
ONKA-8213-RE5-5VFD	5.0	9.0	25.0	13.0	6.5	3.4	0,236	100

## HIZLI KABLO EK YAPMA APARATI



Plastik, Metal  
105 °C çalışma sıcaklığı,  
600 Volt Çalışma Gerilimi

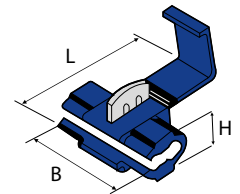

ÜRÜN KODU	KABLO KESİTİ (mm <sup>2</sup> )	B	H	D	ADET (\$)	KUTU ADEDİ
TB-1	0,5 - 1,0	20.0	8.0	25.0	0,140	100
TB-2	1,0 - 2,5	20.0	8.0	25.0	0,154	100
TB-5	4,0 - 6,0	20.0	11.0	35.0	0,222	100

# Onka®

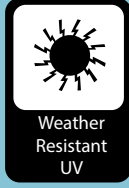
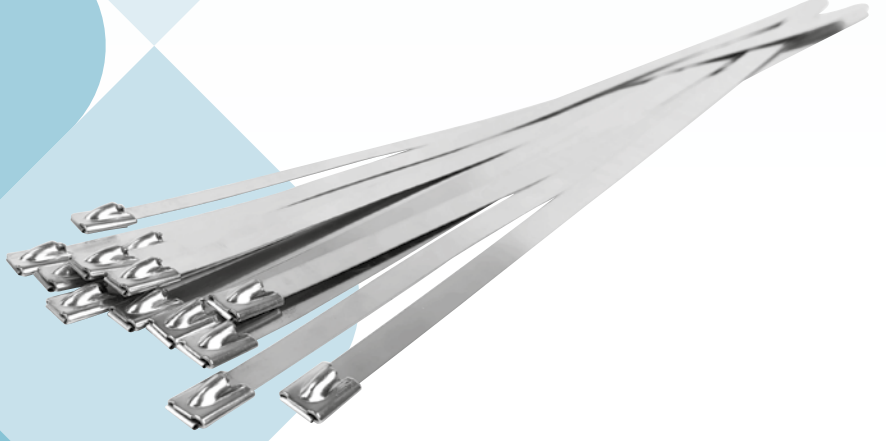

## KABLO BAĞLARI ve AKSESUARLARI



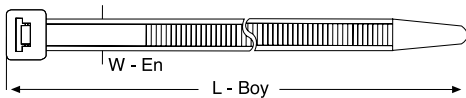
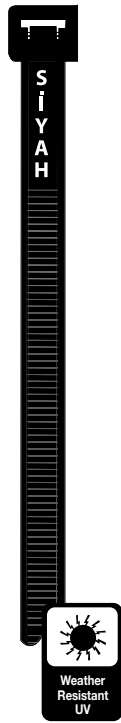
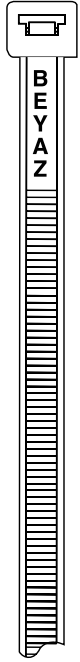

ÜRÜN KODU	L	W	MAK. BAĞLAMA ÇAPI	TAŞI. AĞIRLIK (kg)	ADET (\$)	POŞET ADEDİ	KOLİ ADEDİ
ONKA-8480	100	2,5	22	8,00	0,007	100 / 1000	26.000
ONKA-8432	150	2,5	35	8,00	0,011	100 / 1000	20.000
ONKA-8482	200	2,5	50	8,00	0,016	100 / 1000	18.000
ONKA-8483	140	3,5	31	18,00	0,016	100 / 1000	12000
ONKA-8484	200	3,5	50	18,00	0,026	100 / 1000	10000
ONKA-8485	250	3,5	65	18,00	0,030	100 / 1000	8000
ONKA-8486	280	3,5	74	18,00	0,038	100 / 1000	8000
ONKA-8487	370	3,5	98	18,00	0,046	100 / 1000	6000
ONKA-8489	200	4,5	50	22,00	0,035	100	7.000
ONKA-8490	250	4,5	65	22,00	0,043	100	6.000
ONKA-8491	300	4,5	80	22,00	0,050	100	5.000
ONKA-8492	370	4,5	98	22,00	0,063	100	4.000
ONKA-8493	430	4,5	120	22,00	0,076	100	3.000
ONKA-8495	300	7,5	75	55,00	0,105	100	3.000
ONKA-8496	370	7,5	98	55,00	0,124	100	2.500
ONKA-8497	450	7,5	120	55,00	0,145	100	2.000
ONKA-8498	550	7,5	155	55,00	0,188	100	1.500
ONKA-8514	750	7,5	220	55,00	0,254	100	1200
ONKA-8507	600	9,0	165	80,00	0,276	100	1.200
ONKA-8502	710	9,0	205	80,00	0,339	100	1.200
ONKA-8524	760	9,0	220	80,00	0,349	100	1.200
ONKA-8504	900	9,0	260	80,00	0,414	100	1.200
ONKA-8505	1200	9,0	370	80,00	0,610	100	1.000

ONKA ürünleri DUPONT marka, nylon 6/6 hammaddeden imal edilmiş olup, - 40 + 85 °C ortam sıcaklığında çalışır. UL 94 / V2 normunda, kendini söndürme özelliğine sahiptir. Yüksek kaliteli ONKA kablo bağları (benzin, motorin, hayvansal yağ, boya, vernik) gibi maddelere karşı üstün direnç göstermektedir. Ürünler beyaz / siyah ve yandaki renkler olarak STOKLARIMIZDA mevcuttur. Beyaz / siyah renk dışındaki kablo bağlarının fiyatları farklıdır. Diğer renk istekleriniz için firmamızla irtibata geçiniz.

**Siyah renkli ürünlerimiz dış ortam kullanımına uygun UV dayanımlıdır.**



## RENKLİ KABLO BAĞLARI

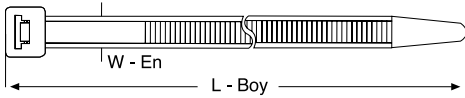
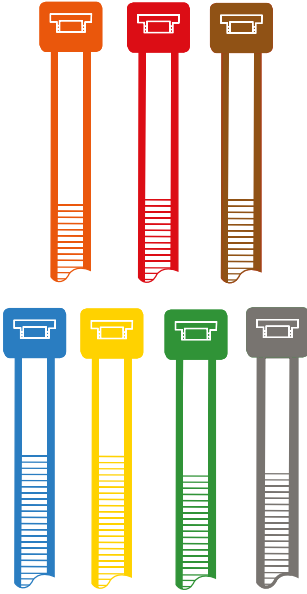

ÜRÜN KODU	L	W	MAK. BAĞLAMA ÇAPI	TAŞI. AĞIRLIK (kg)	ADET (\$)	POŞET ADEDİ	KOLİ ADEDİ
ONKA - 8178	100	2.5	22	8.1	0,013	1000	80.000
ONKA - 8179	140	2.5	40	8.1	0,018	100	50.000
ONKA - 8180	200	2.5	53	8.1	0,026	100	35.000
ONKA - 8181	150	3.6	35	18.2	0,030	100	30.000
ONKA - 8182	200	3.6	53	18.2	0,039	100	25.000
ONKA - 8183	250	3.6	65	18.2	0,048	100	20.000
ONKA - 8184	300	3.6	76	18.2	0,058	100	20.000
ONKA - 8152	200	4.8	50	22.2	0,046	100	17.000
ONKA - 8154	250	4.8	60	22.2	0,056	100	15.000
ONKA - 8185	300	4.8	76	22.2	0,083	100	15.000
ONKA - 8205	370	4.8	102	22.2	0,095	100	12.000
ONKA - 8209	370	8	102	54.5	0,188	100	6.000
ONKA - 8218	450	8	127	54.5	0,216	100	3.500
ONKA - 8219	530	8	140	54.5	0,284	100	3.000

## PASLANMAZ ÇELİK KABLO BAĞLARI

(AISI 304-316 Paslanmaz Çelik)

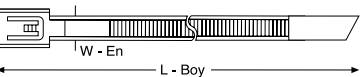

L	W	Sıkma Çapı (mm)	Açılma Mukv. (kg)	ÜRÜN KODU 304 Paslanmaz	ADET (\$) 304 Paslanmaz	ÜRÜN KODU 316 Paslanmaz	ADET (\$) 316 Paslanmaz	POŞET ADEDİ	KOLİ ADEDİ
150	4.6	33	55	ONK-150-46-W4	0,324	ONK-150-46-W5	0,443	100	8000
200	4.6	50	55	ONK-200-46-W4	0,375	ONK-200-46-W5	0,490	100	6000
250	4.6	67	55	ONK-250-46-W4	0,443	ONK-250-46-W5	0,583	100	5000
300	4.6	75	55	ONK-300-46-W4	0,466	ONK-300-46-W5	0,608	100	5000
370	4.6	102	55	ONK-370-46-W4	0,490	ONK-370-46-W5	0,653	100	4000
520	4.6	152	55	ONK-520-46-W4	0,614	ONK-520-46-W5	0,794	100	3000
680	4.6	203	55	ONK-680-46-W4	0,652	ONK-680-46-W5	0,861	100	2000
840	4.6	254	55	ONK-840-46-W4	0,747	ONK-840-46-W5	0,981	100	1000
200	7.9	50	120	ONK-200-79-W4	0,466	ONK-200-79-W5	0,583	100	5000
300	7.9	75	120	ONK-300-79-W4	0,583	ONK-300-79-W5	0,747	100	4000
370	7.9	102	120	ONK-370-79-W4	0,699	ONK-370-79-W5	0,861	100	3000
520	7.9	152	120	ONK-520-79-W4	0,909	ONK-520-79-W5	1,119	100	2000
680	7.9	203	120	ONK-600-79-W4	1,145	ONK-600-79-W5	1,419	100	2000
840	7.9	254	120	ONK-840-79-W4	1,652	ONK-840-79-W5	2,126	100	1000

## ÖZEL KABLO BAĞLARI



### KULLANIM ALANLARI

Gıda ve ilaç endüstrilerinde kullanılan tipik metal dedektörleri, metal algılama sistemleri ve X-Ray kontrol sistemleri tarafından algılanma ve reddedilme yeteneğine sahiptir.

Özellikle gıda ve ilaç endüstrilerinde hammadde, yarımamül, diğer ürün yan girdi ambalajları, poşet, torba, çuval ağzlarının bağlanmasında, üretim hatlarındaki elektrik kablo, boru ve boru demetlerinin bağlanmasında ve diğer tesisatların sabitlenmesinde, ürün kirlenme riski bulunan makine aksamalarının sabitlenmesinde vb... ve diğer bir çok uygulama alanında kullanılmak üzere tasarlanmıştır. Kuvvetli ve dayanıklı malzemelerden Naylon 6, Naylon 6.6, Polypropilen malzemelerden yapılmıştır.

Ürün boyunca dağıtılmış metal içeriğe sahiptir ve bu sebeple parçalar halinde kesilseler dahi tespit edilebilme özelliğine sahiptir.

### Genel Özellikler :

- Metal algılama sistemleri (metal dedektörü ve mıknatıs) tarafından tespit edilebilir,
- X-Ray kontrol sistemleri tarafından tespit edilebilir,
- HACCP sisteminin bir parçası olarak kullanılabilir,
- Farklı renk seçenekleri mevcuttur (sadece DTMN 0500 ürünü için geçerli),
- Uygun maliyetlidir,
- Çevre dostudur.

**METAL  
DEDEKTÖRLERİ**

**X-RAY KONTROL  
SİSTEMLERİ**

**ENDÜSTRİYEL  
MIKNATISLAR**



### KİLİTLİ KABLO BAĞI

ÜRÜN KODU	RENK	BOY (mm)	EN (mm)	ADET (t)	POŞET ADEDİ
DTMN 01523	MAVİ	92	2,4	Ⓢ	100
DTMN 01525		186	4,8		
DTMN 01527		340	7		
DTMN 01528		360	4,8		

### KABLO BAĞI

ÜRÜN KODU	RENK	BOY (mm)	EN (mm)	ADET (t)	POŞET ADEDİ
DTMN 01529	MAVİ	150	3,5	Ⓢ	100
DTMN 01530		200	4,6		
DTMN 01531		145	3,4		
DTMN 01532		185	4,6		
DTMN 01533		380	4,7		
DTMN 01540		390	7,6		

### RENKLİ KABLO BAĞI

ÜRÜN KODU	RENK	BOY (mm)	EN (mm)	ADET (t)	POŞET ADEDİ
DTMN 0500	MAVİ	390	4,6	Ⓢ	100
	KIRMIZI				
	SARI				
	YEŞİL				
	TURUNCU				

### TEKRAR KULLANILABİLİR KABLO BAĞI

ÜRÜN KODU	RENK	BOY (mm)	EN (mm)	ADET (t)	POŞET ADEDİ
DTMN 01539	MAVİ	250	4,7	Ⓢ	100



## PANELE KAFADAN SIKIŞAN KABLO BAĞI

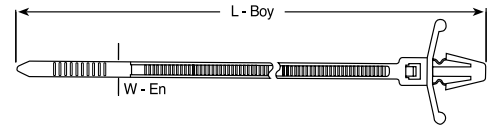

ÜRÜN KODU	L	W	MAKSİMUM BAĞLAMA ÇAPI	TAŞIMA AĞIRLIĞI (kg)	DELİK ÇAPI (Ø)	ADET (\$)	POŞET ADEDİ
ONKA - 8380	100	2.5	22	12	Ø 4.8	0,044	1000
ONKA - 8382	200	4.8	46	25	Ø 6.4	0,072	100

## ETIKETLİ KABLO BAĞI

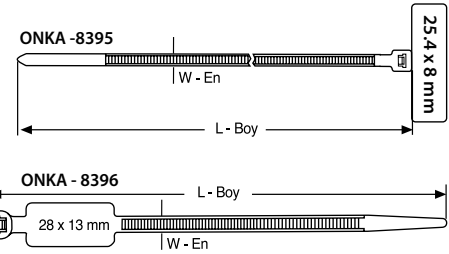
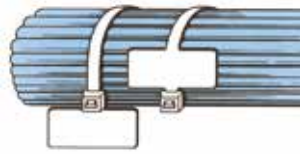
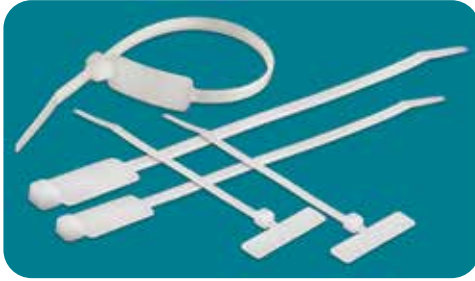

ÜRÜN KODU	L	W	MAKSİMUM BAĞLAMA ÇAPI	TAŞIMA AĞIRLIĞI (kg)	ADET (\$)	POŞET ADEDİ
ONKA - 8395	100	2.5	18	8.1	0,051	100
ONKA - 8396	195	4.8	45	22.2	0,106	100

## KAFADAN VİDA MONTAJLI KABLO BAĞI

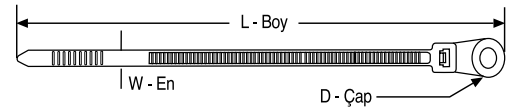

ÜRÜN KODU	L	W	D	MAKSİMUM BAĞLAMA ÇAPI	TAŞIMA AĞIRLIĞI (kg)	ADET (\$)	POŞET ADEDİ
ONKA - 8411	200	4,8	4,8	54	22,2	0,076	1000

## BONCUK TİP KABLO BAĞI



ÜRÜN KODU	L	W	MAKSİMUM BAĞLAMA ÇAPI	TAŞIMA AĞIRLIĞI (kg)	ADET (\$)	POŞET ADEDİ
GTB-110 M	105	2	25	5	0,019	1.000
GTB-150 I	165	3.5	45	7	0,040	500

## BÜKÜLEBİLİR KLİPS

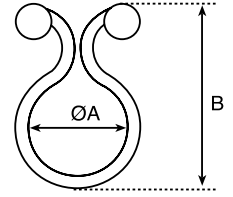

ÜRÜN KODU	ÜRÜN CİNSİ	ØA	B	MAKSİMUM BAĞLAMA ÇAPı	ADET (\$)	POŞET ADEDİ
ONKA-8372	TH-F	8,3	25,2	7,3	0,022	1000
ONKA-8373	TH-G	11,5	30,9	10,5	0,026	1000
ONKA-8374	TH-H	15,0	35,1	14,0	0,030	1000

## FLAT CABLE KABLO TUTUCUSU

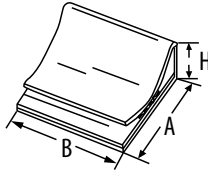

ÜRÜN KODU	A	B	H	ADET (\$)	KUTU ADEDİ
ONKA-8433	15	26	6,5	0,308	100
ONKA-8434	25	26	10	0,465	100

## TABANI YAPIŞKANLI KANCALI KLİPS

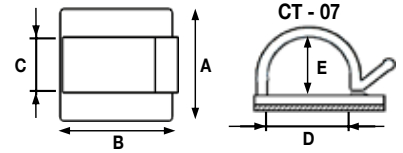

ÜRÜN KODU	A	B	C	D	MAKS. BAĞLAMA GENİŞLİĞİ (E)	ADET (\$)	POŞET ADEDİ
CT-05	25	25	12,7	12,5	8	0,121	100
CT-07	25	25	12,7	16,5	12	0,129	100

## VİDALI KROŞELER

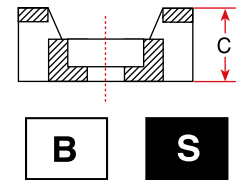
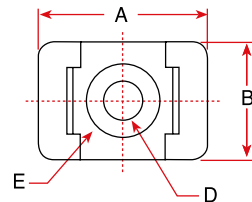

ÜRÜN KODU	A	B	C	D	E	MAKS. BAĞLAMA GENİŞLİĞİ	ADET (\$)	POŞET ADEDİ
ONKA-8360	2	14,9	9,5	6,9	4,5	7,8	0,042	100
ONKA-8361	3	22,2	15,9	9,7	6,4	12,6	0,057	100
ONKA-8595	5	30,0	15,0	11,7	4,8	-	0,067	100

## KABLO SIKIŞTIRICILARI

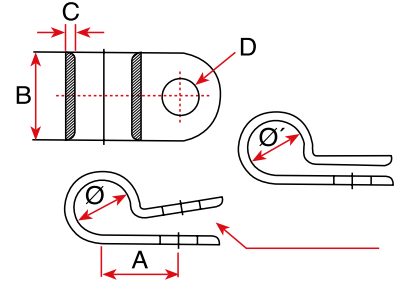

ÜRÜN KODU	Ø	Ø'	A	B	C	D	ADET (\$)	POŞET ADEDİ
ONKA - 8450 1/8S	3.6	3.3	8.2	9.1	1.27	M 5	0,030	100
ONKA - 8451 3/16S	5.3	4.8	9.6	9.1	1.27	M 5	0,036	100
ONKA - 8452 1/4S	7.4	6.6	10.3	9.1	1.27	M 5	0,034	100
ONKA - 8453 5/16S	8.9	7.8	10.6	9.1	1.27	M 5	0,040	100
ONKA - 8454 3/8S	10.9	9.7	11.9	9.2	1.27	M 5	0,044	100
ONKA - 8457 3/8	9.5	9.1	13.4	12.7	1.50	M 5	0,064	100

## BETON KROŞE

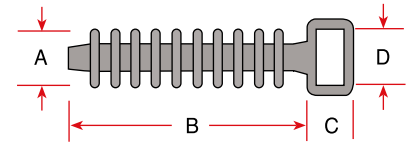

ÜRÜN KODU	A	B	C	D	MAKS. BAĞLAMA GENİŞLİĞİ	ADET (\$)	KUTU ADEDİ
ONKA - 8362	9,5	36,0	6,0	9,5	9,5	0,066	100

## BASKILI DEVRE TAŞIYICILARI

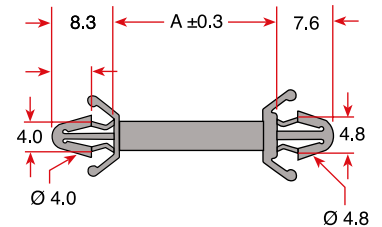

ÜRÜN KODU	ÖLÇÜ (A)	ADET (\$)	KUTU ADEDİ
ONKA-8420 CBS-6A	6,2	0,042	1000
ONKA-8421 CBS-9A	9,2	0,046	1000
ONKA-8422 CBS-13A	12,6	0,047	1000

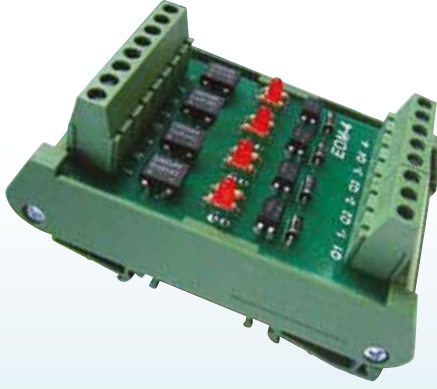

## DİYOT MODÜLLERİ

### Diyot Kartları

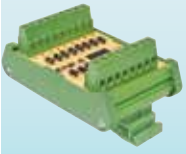

**Özelliği :** 7 farklı tipte imal edilmektedirler. 6'lı, 12'li, 14'lü ortak anot, 14'lü ortak katot, 22'li ortak anot ve 22'li ortak katot şeklindedir. Diyot ihtiyaç olan yerlerde klemens bağlantısı olmasından dolayı tercih edilir. Diyotlar 1 A ve 700 V olarak kullanılmaktadır.

### Optokupler Modülleri



**Özelliği:** PLC veya micro işlemcili sistemlerde güç devresi ile elektronik devreyi elektriksel olarak birbirlerinden izole ederek PLC veya mikro işlemcinin bozulmasını engeller. Bu kartımız PLC veya mikro işlemciye giriş/çıkış olarak kullanılır. 4 kanalıdır. Genellikle giriş sinyallerinin güçlendirilmesi ve izole edilmesi için tercih edilir. Kartımızın girişi 5 V DC -12 - 24 V DC çıkışı ise 24 V DC, NPN 'dir (Yani "-" çıkış). Her iki devrede izole halindedir. Üzerindeki LED ile çalışması takip edilebilir.

### Lamba Test Kartları



**Özelliği :** Makina veya elektrik panosundaki sinyal lambalarını kontrol eder. 8 - 11 - 16 kanallı 3 tip imal edilmektedir.

## DİYOT MODÜLLERİ

### OPTOKUPLER MODÜLÜ



ÜRÜN KODU	AÇIKLAMA	ADET (t)
ONKA-130-EOM-4	Optokupler Kartı 4 Kanallı 5 VDC Giriş, 24 VDC Çıkış, NPN	1.400,00
ONKA-131-EOM-4	Optokupler Kartı 4 Kanallı 12 VAC / DC Giriş, 24 VDC Çıkış, NPN	1.400,00
ONKA-132-EOM-4	Optokupler Kartı 4 Kanallı 24 VAC / DC Giriş, 24 VDC Çıkış, NPN	1.400,00

### LAMBA TEST MODÜLLERİ

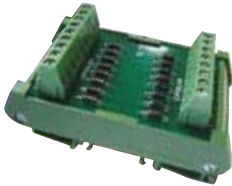

ÜRÜN KODU	AÇIKLAMA	ADET (t)
ONKA-120-ELT8	Lamba Test Kartı 8 Kanallı	☎
ONKA-122-ELT11	Lamba Test Kartı 11 Kanallı	☎
ONKA-121-ELT16	Lamba Test Kartı 16 Kanallı	868,00

### DİYOT KARTLARI

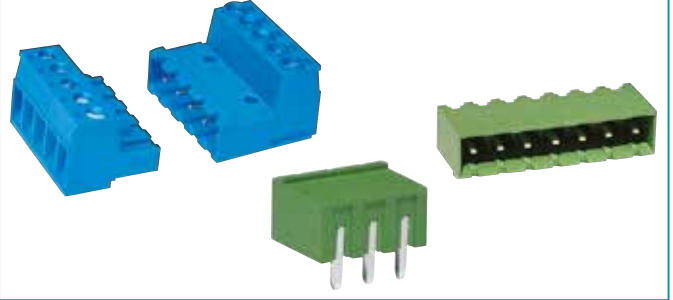
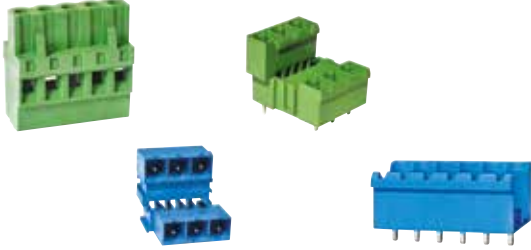
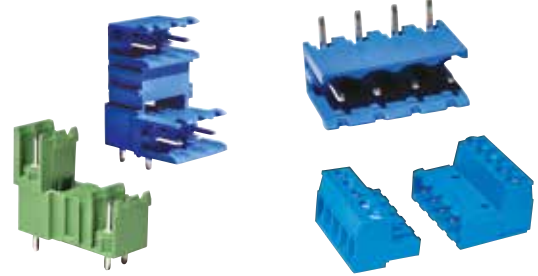
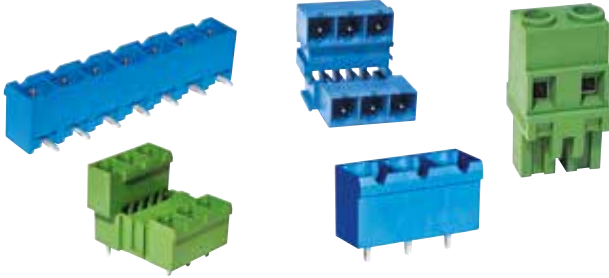
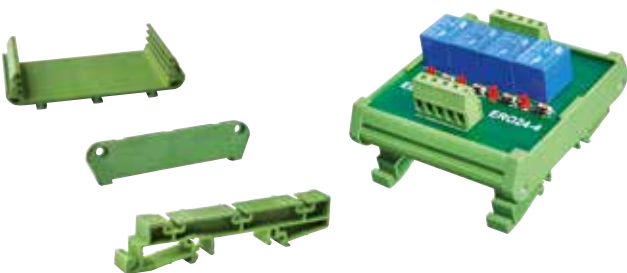
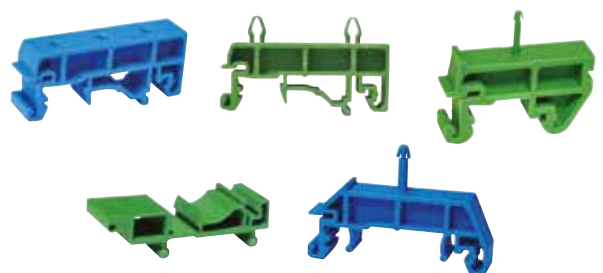

ÜRÜN KODU	AÇIKLAMA	ADET (t)
ONKA-101-EDM6	Diyot Kartı 6 Kanallı	550,00
ONKA-102-EDM8	Diyot Kartı 8 Kanallı	630,00
ONKA-103-EDM12	Diyot Kartı 12 Kanallı	655,00
ONKA-105-EDMK14	Diyot Kartı 14 Kanallı Ortak Katot	725,00
ONKA-106-EDM22A	Diyot Kartı 22 Kanallı Ortak Anot	760,00
ONKA-107-EDM22K	Diyot Kartı 22 Kanallı Ortak Katot	760,00

**GÜÇ KLEMENSİ (3.81 x 12.7 x 15.24 mm)****SOKETLİ PCB KLEMENS SERİSİ (3.81mm)****SOKETLİ PCB KLEMENS SERİSİ (5.08mm)****SOKETLİ PCB KLEMENS SERİSİ (5.08mm)****SOKETLİ PCB KLEMENS SERİSİ (7.62mm)****MODÜL PCB KLEMENS SERİSİ****SMD KLEMENS SERİSİ****VİDASIZ KLEMENS SERİSİ****KART YUVASI SERİSİ****DİSTANS SERİSİ (RAY DİSTANS)**



**KAEEL**



**AŞIRI VE DÜŞÜK GERİLİM  
KORUMA RÖLESİ**



**ÇİFT YÖNLÜ REAKTİF  
GÜÇ DENGELİYİCİ**

**SICAKLIK  
KONTROL CİHAZLARI**

### SEVİYE KONTROL ve GERİLİM KORUMA RÖLELERİ



### FAZ KORUMA RÖLELERİ



### ZAMAN ve AKIM KORUMA RÖLELERİ



### ÖZEL ve FOTOSEL RÖLELER





Uniels

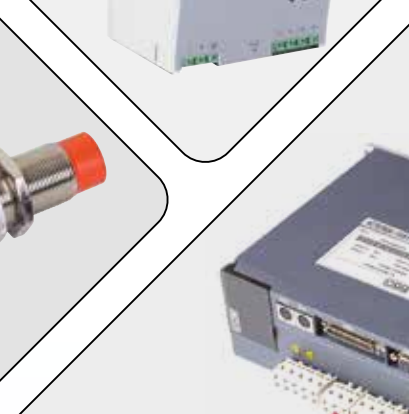

**ISISO**  
ISISO ENDÜSTRİYEL OTOMASYON ÜRÜNLERİ



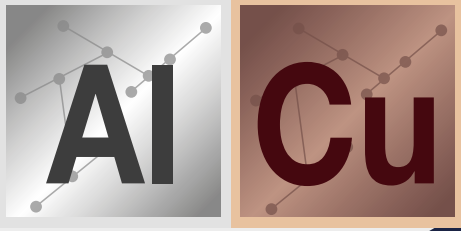

## TBA SERİSİ BİMETAL TERMİNAL BLOKLARI



Standartlar  
EN 60947-7-1:2019  
EN 61238-1-1:2019 (Class A)

## TBA SERİSİ BİMETAL TERMİNAL BLOKLARI - 16 mm<sup>2</sup>

1 POLE

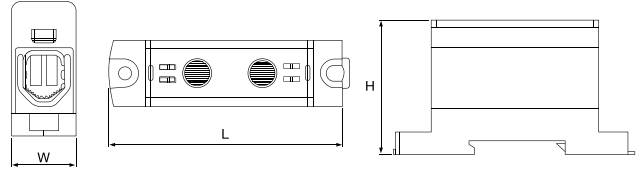

Ürün Kodu	İletken Kesiti	Renk	Nominal Gerilim (V)	Nominal Akım (A)	Ölçüler (mm)			Sıkma Torku	Vida, Alyan Anahtar	ADET (\$)	Kutu Adedi
					W	H	L				
TBA 1016A1	1x0-16mm <sup>2</sup>	Grey	1.000 V AC 1.500 V DC								
TBA 1016A2		Blue									
TBA 1016A3		Green									
TBA 1016A4		Brown									
TBA 1016A5		Black									
TBA 1016A6		Red									
TBA 2016A1	2x0-16mm <sup>2</sup>	Grey	1.000 V AC 1.500 V DC								
TBA 2016A2		Blue									
TBA 2016A3		Green									
TBA 2016A4		Brown									
TBA 2016A5		Black									
TBA 2016A6		Red									
TBA 3016MA1	3x0-16mm <sup>2</sup>	Grey	1.000 V AC 1.500 V DC								
TBA 3016MA2		Blue									
TBA 3016MA3		Green									
TBA 3016MA4		Brown									
TBA 3016MA5		Black									
TBA 3016MA6		Red									

## TBA SERİSİ BİMETAL TERMİNAL BLOKLARI - 35 mm<sup>2</sup>

1 POLE

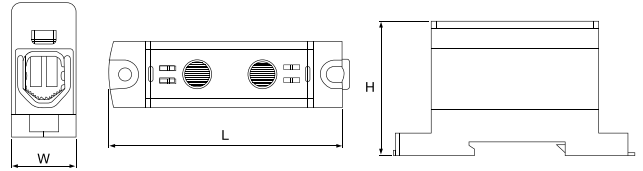

Ürün Kodu	İletken Kesiti	Renk	Nominal Gerilim (V)	Nominal Akım (A)	Ölçüler (mm)			Sıkma Torku	Vida, Alyan Anahtar	ADET (\$)	Kutu Adedi
					W	H	L				
TBA 1035A1	1x16-35mm <sup>2</sup>	Grey	1.000 V AC 1.500 V DC								
TBA 1035A2		Blue									
TBA 1035A3		Green									
TBA 1035A4		Brown									
TBA 1035A5		Black									
TBA 1035A6		Red									
TBA 2035A1	2x16-35mm <sup>2</sup>	Grey	1.000 V AC 1.500 V DC								
TBA 2035A2		Blue									
TBA 2035A3		Green									
TBA 2035A4		Brown									
TBA 2035A5		Black									
TBA 2035A6		Red									
TBA 3035MA1	3x16-35mm <sup>2</sup>	Grey	1.000 V AC 1.500 V DC								
TBA 3035MA2		Blue									
TBA 3035MA3		Green									
TBA 3035MA4		Brown									
TBA 3035MA5		Black									
TBA 3035MA6		Red									

## TBA SERİSİ BİMETAL TERMİNAL BLOKLARI - 50 mm<sup>2</sup>

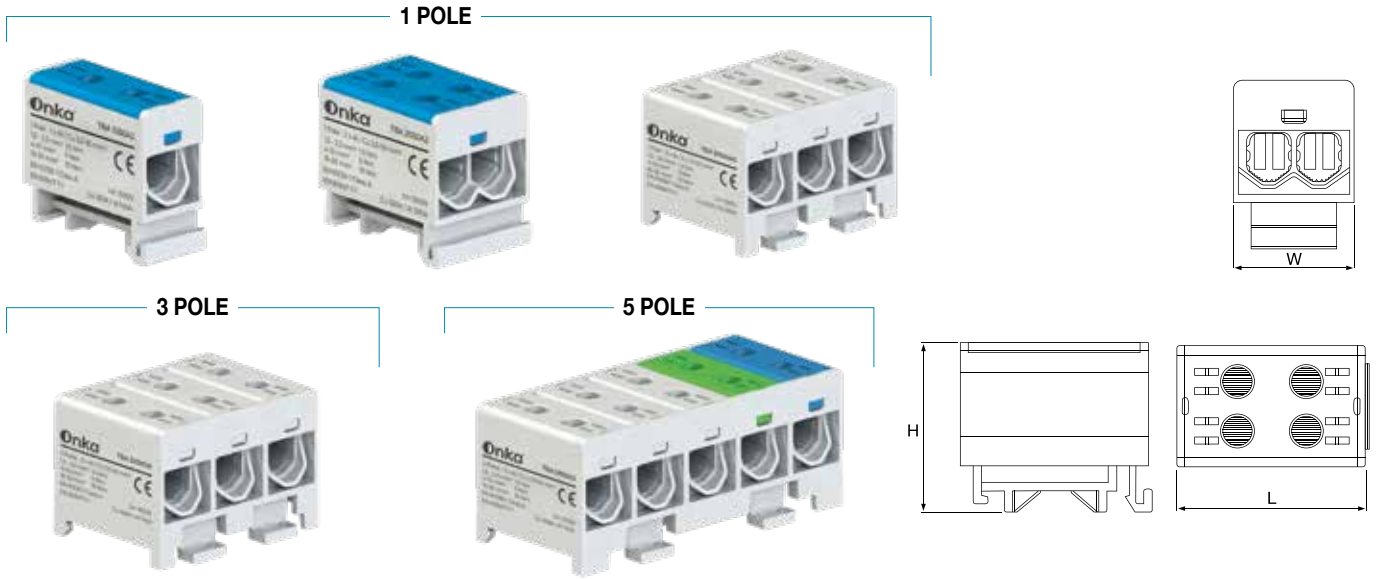

Ürün Kodu	İletken Kesiti	Renk	Nominal Gerilim (V)	Nominal Akım (A)	Ölçüler (mm)			Sıkma Torku	Vida, Alyan Anahtar	ADET (\$)	Kutu Adedi
					W	H	L				
TBA 1050A1	1x2,5-50mm <sup>2</sup>	●	1.000 V AC 1.500 V DC	160 (Cu) 145 (Al)	20,2	40,5	45,2	1,5 Nm (2,5-2,5mm <sup>2</sup> )  5 Nm (4-10 mm <sup>2</sup> )  10 Nm (16-50 mm <sup>2</sup> )	No.5	4,00 \$	24
TBA 1050A2		●								4,20 \$	
TBA 1050A3		●								4,20 \$	
TBA 1050A4		●								4,20 \$	
TBA 1050A5		●								4,20 \$	
TBA 1050A6		●								4,20 \$	
TBA 2050A1	2x2,5-50mm <sup>2</sup>	●	1.000 V AC 1.500 V DC	320 (Cu) 290 (Al)	29,2	40,5	45,2	1,5 Nm (2,5-2,5mm <sup>2</sup> )  5 Nm (4-10 mm <sup>2</sup> )  10 Nm (16-50 mm <sup>2</sup> )	No.5	7,00 \$	16
TBA 2050A2		●								7,20 \$	
TBA 2050A3		●								7,20 \$	
TBA 2050A4		●								7,20 \$	
TBA 2050A5		●								7,20 \$	
TBA 2050A6		●								7,20 \$	
TBA 3050MA1	3x2,5-50mm <sup>2</sup>	●	1.000 V AC 1.500 V DC	320 (Cu) 290 (Al)	60,0	40,5	45,2	1,5 Nm (2,5-2,5mm <sup>2</sup> )  5 Nm (4-10 mm <sup>2</sup> )  10 Nm (16-50 mm <sup>2</sup> )	No.5	11,80 \$	8
TBA 3050MA2		●								11,80 \$	
TBA 3050MA3		●								11,80 \$	
TBA 3050MA4		●								11,80 \$	
TBA 3050MA5		●								11,80 \$	
TBA 3050MA6		●								11,80 \$	
TBA 3050TA1	3x2,5-50mm <sup>2</sup>	●●●	1.000 V AC 1.500 V DC	160 (Cu) 145 (Al)	60,0	40,5	45,2	1,5 Nm (2,5-2,5mm <sup>2</sup> )  5 Nm (4-10 mm <sup>2</sup> )  10 Nm (16-50 mm <sup>2</sup> )	No.5	11,80 \$	8
TBA 3050TA2		●●●								11,80 \$	
TBA 5050A1	5x2,5-50mm <sup>2</sup>	●●●●●	1.000 V AC 1.500 V DC	160 (Cu) 145 (Al)	100,0	40,5	45,2	1,5 Nm (2,5-2,5mm <sup>2</sup> )  5 Nm (4-10 mm <sup>2</sup> )  10 Nm (16-50 mm <sup>2</sup> )	No.5	19,60 \$	1
TBA 5050A2		●●●●●								19,60 \$	
TBA 5050A3		●●●●●								19,60 \$	

## TBA SERİSİ BİMETAL TERMİNAL BLOKLARI - 95 mm<sup>2</sup>

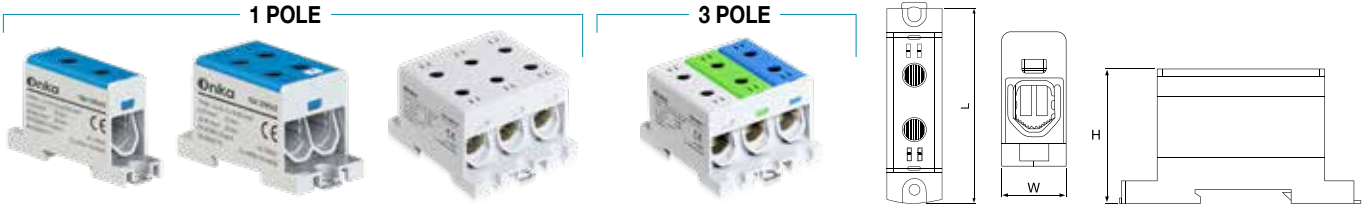

Ürün Kodu	İletken Kesiti	Renk	Nominal Gerilim (V)	Nominal Akım (A)	Ölçüler (mm)			Sıkma Torku	Vida, Alyan Anahtar	ADET (\$)	Kutu Adedi
					W	H	L				
TBA 1095A1	1x6-95mm <sup>2</sup>	●	1.000 V AC 1.500 V DC	245 (Cu) 220 (Al)	25,1	50,7	87,5	12 Nm (6-25mm <sup>2</sup> )  22 Nm (35-95 mm <sup>2</sup> )	No.6	10,00 \$	9
TBA 1095A2		●								10,20 \$	
TBA 1095A3		●								10,20 \$	
TBA 1095A4		●								10,20 \$	
TBA 1095A5		●								10,20 \$	
TBA 1095A6		●								10,20 \$	
TBA 2095A1	2x6-95mm <sup>2</sup>	●	1.000 V AC 1.500 V DC	490 (Cu) 440 (Al)	41,7	50,7	87,5	12 Nm (6-25mm <sup>2</sup> )  22 Nm (35-95 mm <sup>2</sup> )	No.6	17,00 \$	1
TBA 2095A2		●								17,20 \$	
TBA 2095A3		●								17,20 \$	
TBA 2095A4		●								17,20 \$	
TBA 2095A5		●								17,20 \$	
TBA 2095A6		●								17,20 \$	
TBA 3095MA1	3x6-95mm <sup>2</sup>	●	1.000 V AC 1.500 V DC	490 (Cu) 440 (Al)	66,8	50,7	87,5	12 Nm (6-25mm <sup>2</sup> )  22 Nm (35-95 mm <sup>2</sup> )	No.6	27,80 \$	1
TBA 3095MA2		●								27,80 \$	
TBA 3095MA3		●								27,80 \$	
TBA 3095MA4		●								27,80 \$	
TBA 3095MA5		●								27,80 \$	
TBA 3095MA6		●								27,80 \$	
TBA 3095TA1	3x6-95mm <sup>2</sup>	●●●	1.000 V AC	245 (Cu)	66,8	50,7	87,5	12 Nm (6-25mm <sup>2</sup> )  22 Nm (35-95 mm <sup>2</sup> )	No.6	27,80 \$	1
TBA 3095TA2		●●●	1.500 V DC	220 (Al)						27,80 \$	

## TBA SERİSİ BİMETAL TERMİNAL BLOKLARI - 150 mm<sup>2</sup>



Ürün Kodu	İletken Kesiti	Renk	Nominal Gerilim (V)	Nominal Akım (A)	Ölçüler (mm)			Sıkma Torku	Vida, Alyan Anahtar	ADET (\$)	Kutu Adedi
					W	H	L				
TBA 1150A1	1x25-150mm <sup>2</sup>	●	1.000 V AC 1.500 V DC	320 (Cu) 290 (Al)	32,0	59,0	115,6	14 Nm (25-50mm <sup>2</sup> )	No.8	16,80 \$	1
TBA 1150A2		●								17,00 \$	
TBA 1150A3		●								17,00 \$	
TBA 1150A4		●								17,00 \$	
TBA 1150A5		●								17,00 \$	
TBA 1150A6		●								17,00 \$	
TBA 2150A1	2x25-150mm <sup>2</sup>	●	1.000 V AC 1.500 V DC	640 (Cu) 290 (Al)	57,2	59,0	115,6	35 Nm (70-150 mm <sup>2</sup> )	No.8	31,60 \$	1
TBA 2150A2		●								32,00 \$	
TBA 2150A3		●								32,00 \$	
TBA 2150A4		●								32,00 \$	
TBA 2150A5		●								32,00 \$	
TBA 2150A6		●								32,00 \$	

## TBA SERİSİ BİMETAL TERMİNAL BLOKLARI - 240 mm<sup>2</sup>



Ürün Kodu	İletken Kesiti	Renk	Nominal Gerilim (V)	Nominal Akım (A)	Ölçüler (mm)			Sıkma Torku	Vida, Alyan Anahtar	ADET (\$)	Kutu Adedi
					W	H	L				
TBA 1240A1	1x35-240mm <sup>2</sup>	●	1.000 V AC 1.500 V DC	425 (Cu) 380 (Al)	39,0	69,9	127,0	26 Nm (35-120mm <sup>2</sup> )	No.8	26,00 \$	1
TBA 1240A2		●								26,20 \$	
TBA 1240A3		●								26,20 \$	
TBA 1240A4		●								26,20 \$	
TBA 1240A5		●								26,20 \$	
TBA 1240A6		●								26,20 \$	
TBA 2240A1	2x35-240mm <sup>2</sup>	●	1.000 V AC 1.500 V DC	850 (Cu) 380 (Al)	61,7	69,9	127,0	46 Nm (150-240 mm <sup>2</sup> )	No.8	44,80 \$	1
TBA 2240A2		●								45,00 \$	
TBA 2240A3		●								45,00 \$	
TBA 2240A4		●								45,00 \$	
TBA 2240A5		●								45,00 \$	
TBA 2240A6		●								45,00 \$	

## TBA SERİSİ BİMETAL TERMİNAL BLOKLARI - 300 mm<sup>2</sup>



Ürün Kodu	İletken Kesiti	Renk	Nominal Gerilim (V)	Nominal Akım (A)	Ölçüler (mm)			Sıkma Torku	Vida, Alyan Anahtar	ADET (\$)	Kutu Adedi
					W	H	L				
TBA 1300A1	1x25-150mm <sup>2</sup>	●	1.000 V AC 1.500 V DC	490 (Cu) 440 (Al)	47,5	77,8	148,5	30 Nm (95-150mm <sup>2</sup> ) 60 Nm (185-300 mm <sup>2</sup> )	No.8	35,20 \$	1
TBA 1300A2		●								35,60 \$	
TBA 1300A3		●								35,60 \$	
TBA 1300A4		●								35,60 \$	
TBA 1300A5		●								35,60 \$	
TBA 1300A6		●								35,60 \$	

## GÜÇ DAĞITIM BLOKLARI

### MONOBLOK DAĞITICI



ÜRÜN KODU	CİNSİ	ADET (€)	KUTU ADEDİ
FTG-38049 PE	<b>80 A Yeşil</b> Giriş: 1 x 2,5 - 16 mm <sup>2</sup> Çıkış: 4 x 2,5 - 6 mm <sup>2</sup> 2 x 2,5 - 16 mm <sup>2</sup>	15,30 €	1



FTG-38049 N	<b>80 A Mavi</b> Giriş: 1 x 2,5 - 16 mm <sup>2</sup> Çıkış: 4 x 2,5 - 6 mm <sup>2</sup> 2 x 2,5 - 16 mm <sup>2</sup>	16,40 €	1
-------------	---	---------	---



FTG-38041	<b>125 A</b> Giriş: 1 x 10-35 mm <sup>2</sup> 1 x 6 - 16 mm <sup>2</sup> Çıkış: 6 x 2,5 - 16 mm <sup>2</sup>	29,40 €	1
-----------	---	---------	---



FTG-38041 PE	<b>125 A</b> Giriş: 1 x 10-35 mm <sup>2</sup> 1 x 6 - 16 mm <sup>2</sup> Çıkış: 6 x 2,5 - 16 mm <sup>2</sup>	29,40 €	1
--------------	---	---------	---



FTG-38041 N	<b>125 A</b> Giriş: 1 x 16-35 mm <sup>2</sup> 1 x 6 - 16 mm <sup>2</sup> Çıkış: 6 x 2,5 - 16 mm <sup>2</sup>	29,40 €	1
-------------	---	---------	---



FTG-38076	<b>125 A</b> Giriş: 1 x 16-35 mm <sup>2</sup> Çıkış: 10 x 2,5 - 16 mm <sup>2</sup>	44,90 €	1
-----------	--	---------	---



FTG-38074	<b>175 A</b> Giriş: 1 x 16-70 mm <sup>2</sup> Çıkış: 10 x 2,5 - 16 mm <sup>2</sup>	44,90 €	1
-----------	--	---------	---



FTG-38074 PE	<b>175 A</b> Giriş: 1 x 16-70 mm <sup>2</sup> Çıkış: 10 x 2,5 - 16 mm <sup>2</sup>	44,90 €	1
--------------	--	---------	---



ÜRÜN KODU	CİNSİ	ADET (€)	KUTU ADEDİ
FTG-38074 N	<b>175 A Mavi</b> Giriş: 1 x 16 - 70 mm <sup>2</sup> Çıkış: 10 x 2,5 - 16 mm <sup>2</sup>	44,90 €	1



FTG-38032	<b>160 A</b> Giriş: 1 x 10-70 mm <sup>2</sup> Çıkış: 6 x 2,5 - 16 mm <sup>2</sup> Bakır Bara Geçişli	46,40 €	1
-----------	---	---------	---



FTG-38019	<b>400 A</b> Giriş: 1x95-185 mm <sup>2</sup> Çıkış: 2 x 6 - 35 mm <sup>2</sup> 5 x 1,5 - 16 mm <sup>2</sup> 4 x 1,5 - 10 mm <sup>2</sup>	65,20 €	1
-----------	--	---------	---



FTG-38404N	<b>400 A</b> Giriş: 1 x 70 - 240 mm <sup>2</sup> Çıkış: 2 x 35 - 120 mm <sup>2</sup>	69,00 €	1
------------	--	---------	---



FTG-38402	<b>400 A</b> Bara Girişi: 20 x 4 - 25 x 10 mm Çıkış: 2 x 35 - 120 mm <sup>2</sup>	70,00 €	1
-----------	---	---------	---



FTG-38062	<b>800 A</b> Bara Girişi: 1 x 35 - 300 mm Bara Geniřlięi: 50 mm Çıkış 2 x 35 - 300 mm <sup>2</sup>	86,00 €	1
-----------	---	---------	---



FTG-38063	<b>800 A</b> Bara Girişi: 2 x 35 - 300 mm Bara Geniřlięi: 20 mm Çıkış 2 x 35 - 300 mm <sup>2</sup>	86,00 €	1
-----------	---	---------	---

## PRATİK GÜÇ DAĞITIM BLOęU



KA502

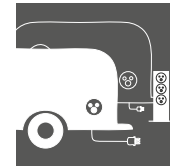
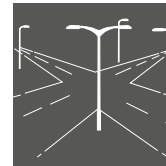
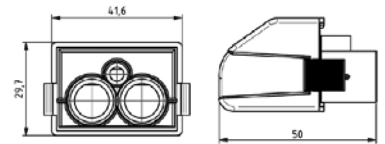

ÜRÜN KODU	CİNSİ	ADET (€)	KUTU ADEDİ
FTG-KA502	1000 V DC, 690 V AC, 2 x 6-35 mm <sup>2</sup> , 160A(Cu), 125A(AL)	10,80 €	1

## 3 FAZLI MONOBLOK DAĞITICI



ÜRÜN KODU	CİNSİ	ADET (€)	KUTU ADEDİ
FTG-38075	<b>125 A, (3 FAZ)</b> Giriş: 1 x 10 - 35 mm <sup>2</sup> Çıkış: 6 x 2,5 - 16 mm <sup>2</sup>	83,00 €	1

## İKİ GİRİŞ İKİ ÇIKIŞ ALTERNATİFLERİ



KVIAC12050YG

ÜRÜN KODU	CİNSİ	GİRİŞ ÇIKIŞ	KABLO KESİTİ ARALIĞI	AKIM		ADET (€)	KUTU ADEDİ
				CU	AL		
FTG-KVIAC12240G	2 Giriş, 2 Çıkış, 2 x 35 - 240 mm <sup>2</sup> Gri	2/2	35 - 240 mm <sup>2</sup>	2x400	315	98,00 €	1

## DiĞER GİRİŞ ÇIKIŞ ALTERNATİFLERİ



KVIAC51016G



KVIAC32035G

ÜRÜN KODU	CİNSİ	GİRİŞ ÇIKIŞ	KABLO KESİTİ ARALIĞI	AKIM		ADET (€)	KUTU ADEDİ
				CU	AL		
FTG-KVIAC51016G	2,5 - 16 mm <sup>2</sup> Gri	5x1 / 5x1	2,5 - 16 mm <sup>2</sup>	5x80	63	34,00 €	10
FTG-KVIAC32035G	2,5 - 35 mm <sup>2</sup> Gri	3x2 / 3x2	2,5 - 35 mm <sup>2</sup>	3x2x160	125	51,25 €	1

## TAM İZOLELİ DAĞITICI ÜNİTELER



ÜRÜN KODU	CİNSİ	ADET (€)	KUTU ADEDİ
FTG-38811	125A, GRİ Giriş : 2 x 10 - 35, Çıkış : 2 x 2,5 - 25,6 x 1,5 - 16	33,00 €	10
FTG-38811N	125A, MAVİ Giriş : 2 x 10 - 35, Çıkış : 2 x 2,5 - 25,6 x 1,5 - 16	33,00 €	5
FTG-38811PE	125A, YEŞİL Giriş : 2 x 10 - 35, Çıkış : 2 x 2,5 - 25,6 x 1,5 - 16	33,00 €	5
FTG-38811R	125A, KIRMIZI Giriş : 2 x 10 - 35, Çıkış : 2 x 2,5 - 25,6 x 1,5 - 16	33,00 €	6
FTG-38812	160A, GRİ Giriş : 2 x 25 - 70, Çıkış : 3 x 2,5 - 25, 8 x 1,5 - 16	36,50 €	3
FTG-38812N	160A, MAVİ Giriş : 2 x 25 - 70, Çıkış : 3 x 2,5 - 25, 8 x 1,5 - 16	36,50 €	3
FTG-38812PE	160A, YEŞİL Giriş : 2 x 25 - 70, Çıkış : 3 x 2,5 - 25, 8 x 1,5 - 16	36,50 €	30

## KOMPLE İZOLELİ DAĞITICI ÜNİTELER



ÜRÜN KODU	CİNSİ	KABLO KESİTİ	ADET (€)	KUTU ADEDİ
FTG-870 S/15FS	15 x 16 mm <sup>2</sup> Yeşil	16 mm <sup>2</sup>	5,70 €	10



## GÜÇ DAĞITIM BLOKLARI ve GÜÇ KLEMENSLERİ

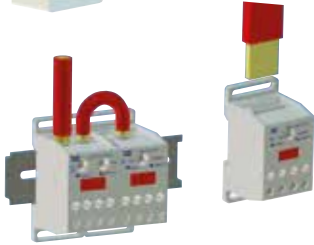

### Renk Kodları

■ - Y	■ - B
■ - G	■ - YG
■ - R	■ - LG

ÜRÜN KODU	CİNSİ	ADET (\$)	KUTU ADEDİ
XK2-35 / 10 x 4	125 A, Giriş 35 mm <sup>2</sup> - Çıkış : 4 x 10 mm <sup>2</sup>	15,56 \$	20
XK2-50 / 10 x 6	150 A, Giriş 50 mm <sup>2</sup> - Çıkış : 6 x 10 mm <sup>2</sup>	19,60 \$	12
XK2-50 / 16 x 4	150 A, Giriş 50 mm <sup>2</sup> - Çıkış : 4 x 16 mm <sup>2</sup>	19,60 \$	12
XK2-70 / 10 x 8	192 A, Giriş 70 mm <sup>2</sup> - Çıkış : 8 x 10 mm <sup>2</sup>	24,80 \$	10
XK2-70 x 2 / 10 x 8	192 A, Giriş 2 x 70 mm <sup>2</sup> - Çıkış : 8 x 10 mm <sup>2</sup>	29,40 \$	10
XK2-70 / 16 x 6	192 A, Giriş 70 mm <sup>2</sup> - Çıkış : 6 x 16 mm <sup>2</sup>	24,80 \$	10
XK2-95 / 25 x 4	232A, Giriş 95 mm <sup>2</sup> - Çıkış : 4 x 25 mm <sup>2</sup>	32,00 \$	10
XK2-120 / 16 x 8	232 A, Giriş 120 mm <sup>2</sup> - Çıkış : 8 x 16 mm <sup>2</sup>	47,36 \$	10



ÜRÜN KODU	CİNSİ	ADET (\$)	KUTU ADEDİ
XK2S-25/10x2+4x2	100 A, 25 mm <sup>2</sup> Düz pin, Çıkış : 2 x 4 mm <sup>2</sup> , 2 x 10 mm <sup>2</sup>	9,24 \$	40
XK2S-35/10x2+4x2	125 A, 35 mm <sup>2</sup> M6 delikli pin, Çıkış : 2 x 4 mm <sup>2</sup> , 2 x 10 mm <sup>2</sup>	9,24 \$	40
XK2S-35 / 4 x 9	125 A, 35 mm <sup>2</sup> M6 delikli pin, Çıkış : 9 x 4 mm <sup>2</sup>	10,52 \$	40
XK2S-70 / 16 x 4	192 A, 70 mm <sup>2</sup> M8 delikli pin, Çıkış : 4 x 16 mm <sup>2</sup>	12,60 \$	25

## PANO AYDINLATMA İÇİN LEDLİ BANT ARMATÜR



Pcb Klemensli,  
Aç-Kapa Anahtarlı, Mıknatıslı



ÜRÜN KODU	GÜÇ	EBATLAR	IŞIK AKISI	ADET (\$)
EPL-25037	6 W	200 x 30 x 38 mm	750 lm	11,40 \$
EPL-25067	10 W	300 x 30 x 38 mm	1250 lm	13,00 \$
EPL-25097	12 W	400 x 30 x 38 mm	1500 lm	14,60 \$
EPL-25187	24 W	600 x 30 x 38 mm	3000 lm	19,60 \$
EPL-25367	48 W	1200 x 30 x 38 mm	6000 lm	32,60 \$

## ASANSÖR KUYU AYDINLATMA SİSTEMİ



Çift Yönlü Bağlantı



ÜRÜN KODU	GÜÇ	EBATLAR	IŞIK AKISI	ADET (\$)
EPL-35037	6 W	200 x 30 x 38 mm	750 lm	11,40 \$
EPL-35067	10 W	300 x 30 x 38 mm	1250 lm	13,00 \$
EPL-35097	12 W	400 x 30 x 38 mm	1500 lm	14,60 \$
EPL-35187	24 W	600 x 30 x 38 mm	3000 lm	19,60 \$
EPL-35367	48 W	1200 x 30 x 38 mm	6000 lm	32,60 \$

## PANO İÇİ LED AYDINLATMA

220 / 240 Volt Eko. Led Aydınlatma

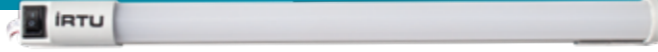

ÜRÜN KODU	ÜRÜN TANIMI	VOLT	BOY ÖLÇÜSÜ	YÜKSEKLİK ÖLÇÜSÜ	ADET (\$)	KOLİ ADEDİ
İR-22030-E	30 cm Plastik Gövde Ekonomik	220 Volt	300	23	9,60 \$	50
İR-22030-ES	30 cm Alüminyum Gövde Ekonomik	220 Volt	300	23	11,00 \$	50

220 / 240 Volt Led Aydınlatma

ÜRÜN KODU	ÜRÜN TANIMI	VOLT	BOY ÖLÇÜSÜ	YÜKSEKLİK ÖLÇÜSÜ	ADET (\$)	KOLİ ADEDİ
İR-22025	25 cm Led Pano Aydınlatması	220 Volt	250	23	16,50 \$	50
İR-22030	30 cm Led Pano Aydınlatması	220 Volt	300	23	17,20 \$	50
İR-22035	35 cm Led Pano Aydınlatması	220 Volt	350	23	18,95 \$	50
İR-22045	45 cm Led Pano Aydınlatması	220 Volt	450	23	20,80 \$	50
İR-22060	60 cm Led Pano Aydınlatması	220 Volt	600	23	25,05 \$	50

Voltaj : 110/220 V AC | Güç : 5 W | IP : 20 | Frekans: 50/60 Hz. | Renk : Beyaz

12 Volt Led Aydınlatma

ÜRÜN KODU	ÜRÜN TANIMI	VOLT	BOY ÖLÇÜSÜ	YÜKSEKLİK ÖLÇÜSÜ	ADET (\$)	KOLİ ADEDİ
İR-12025	25 cm Led Pano Aydınlatması	12 Volt	250	23	15,05 \$	50
İR-12030	30 cm Led Pano Aydınlatması	12 Volt	300	23	15,80 \$	50
İR-12045	45 cm Led Pano Aydınlatması	12 Volt	450	23	20,05 \$	50
İR-12065	65 cm Led Pano Aydınlatması	12 Volt	650	23	24,70 \$	50

Voltaj : 12 V AC | Güç : 4 W | IP : 20 | Renk : Beyaz

24 Volt Led Aydınlatma

ÜRÜN KODU	ÜRÜN TANIMI	VOLT	BOY ÖLÇÜSÜ	YÜKSEKLİK ÖLÇÜSÜ	ADET (\$)	KOLİ ADEDİ
İR-24025	25 cm Led Pano Aydınlatması	24 Volt	250	23	15,05 \$	50
İR-24030	30 cm Led Pano Aydınlatması	24 Volt	300	23	15,80 \$	50
İR-24045	45 cm Led Pano Aydınlatması	24 Volt	450	23	20,05 \$	50
İR-24065	65 cm Led Pano Aydınlatması	24 Volt	650	23	24,70 \$	50

Voltaj : 24 V AC | Güç : 4 W | IP : 20 | Renk : Beyaz

# Onka®

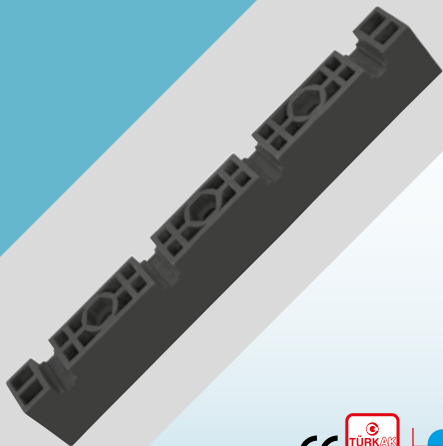
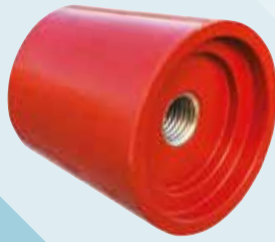

## İRTU

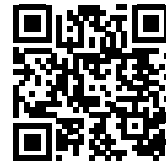

## ÇİFT TARAF SAPLAMALI

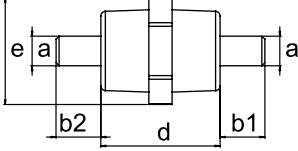

ÜRÜN KODU	TİP	ÖLÇÜLER					SERVIS V	TEST V	TENSİLE	KG	ADET (t)	KUTU ADEDİ
		a	b1	b2	e	d						
PLSM1001	M5	5	12	12	18	25,5	0,6	3	1,00	8,50	57,00	500
PLSM1002	M6	6	16	16	21	29,5	0,6	3	1,00	8,70	70,00	300
PLSM1003	M8	8	15	15	31,5	40	1	3	4,00	7,10	124,00	100
PLSM1004	M10	10	15	15	31,5	40	1	3	4,00	9,50	150,60	100
PLSM1013	M8	8	18	18	43,3	50	1	3	4,00	9,50	247,30	100
PLSM1014	M10	10	18	18	43,3	50	1	3	4,00	9,50	274,90	100

## SAPLAMA & KÖR SOMUNLU

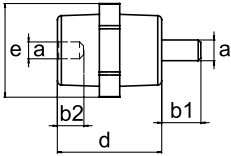

ÜRÜN KODU	TİP	ÖLÇÜLER					SERVIS V	TEST V	TENSİLE	KG	ADET (t)	KUTU ADEDİ
		a	b1	b2	e	d						
PLSM1005	M5	5	12	9	18	25,5	0,6	3	1,00	8,50	74,70	500
PLSM1006	M6	6	16	12	21	29,5	0,6	3	1,00	7,50	86,80	300
PLSM1007	M8	8	15,5	15	31,5	40	1	3	4,00	5,80	148,40	100
PLSM1008	M10	10	15	15	31,5	40	1	3	4,00	7,70	162,50	100
PLSM1015	M8	8	18	15	43,3	50	1	3	4,00	7,70	273,00	100
PLSM1016	M10	10	18	15	43,3	50	1	3	4,00	7,70	286,80	100

## ÇİFT TARAF KÖR SOMUNLU

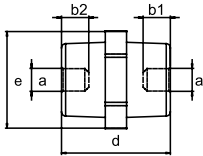

ÜRÜN KODU	TİP	ÖLÇÜLER					SERVIS V	TEST V	TENSİLE	KG	ADET (t)	KUTU ADEDİ
		a	b1	b2	e	d						
PLSM1009	M5	5	9	9	18	25,5	0,6	3	1,00	7,50	85,20	500
PLSM1010	M6	6	12	21	21	29,5	0,6	3	1,00	6,30	102,30	300
PLSM1011	M8	8	15	15	31,5	40	1	3	4,00	5,00	168,90	100
PLSM1012	M10	10	15	15	31,5	40	1	3	4,00	5,00	167,10	100
PLSM1017	M8	8	15	15	43,3	50	1	3	4,00	5,00	295,20	100
PLSM1018	M10	10	15	15	43,3	50	1	3	4,00	5,00	296,00	100
PLSM1019	M12	10	15	15	43,3	50	1	3	4,00	5,00	306,20	100

## ÇİFT TARAF KÖR SOMUNLU

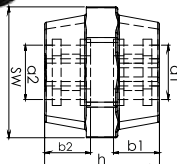
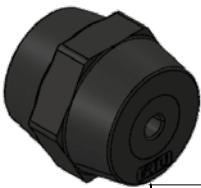

ÜRÜN KODU	TİP	ÖLÇÜLER						Voltaj kV	Test Voltaj	ADET (t)	KUTU ADEDİ
		a1	a2	b1	b2	sw	h				
PLMS303006	M6	M6	M6	11	11	30	30	1	3	165,00	100
PLMS303008	M8	M8	M8	11	11	30	30	1	3	167,80	100
PLMS303010	M10	M10	M10	11	11	30	30	1	3	170,40	100

## PLASTİK (V0) TARAK İZOLATÖRLERİ

### 3x1F TARAK İZOLATÖR

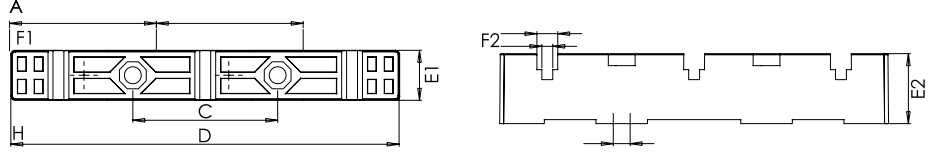

ÜRÜN KODU	TİP	ÖLÇÜLER									MIN	ADET (t)	KUTU ADEDİ
		A	C	D	E1	E2	F1	F2	H				
PLST1001	3X1F/5-10 mm	74	73	196	25	34,5	10,5	5,5	Ø8,5	5	271,20	50	

### 3x1F TARAK İZOLATÖR (4 TİJ)

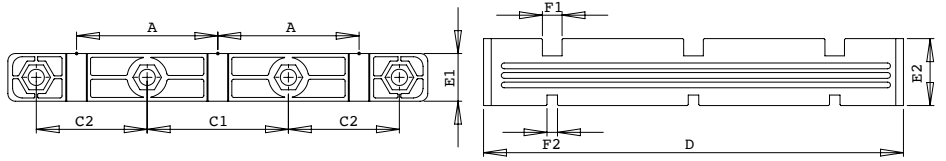

ÜRÜN KODU	TİP	ÖLÇÜLER									MIN	ADET (t)	KUTU ADEDİ
		A	C1	C2	D	E1	E2	F1	F2	H			
PLST1015	3X1F/5-10 mm	74	74	58,14	220	25	35	10,5	5,5	Ø8,5	5	279,80	50

### 3x1F + N TARAK İZOLATÖR

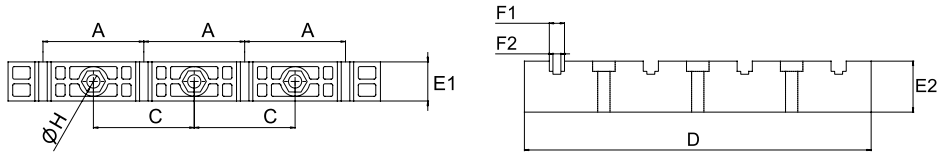

ÜRÜN KODU	TİP	ÖLÇÜLER									MIN	ADET (t)	KUTU ADEDİ
		A	C	D	E1	E2	F1	F2	H				
PLST1003	3X1F+N/5-10 mm	65	65	240	25,5	35,0	10,5	5,5	Ø9	5	369,80	50	

### 3x2F TARAK İZOLATÖR

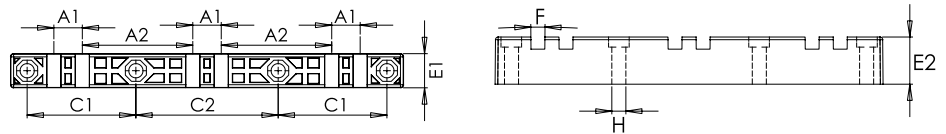

ÜRÜN KODU	TİP	ÖLÇÜLER									MIN	ADET (t)	KUTU ADEDİ
		A1	A2	C1	C2	D	E1	E2	F1	H			
PLST1002	3X2F/10 mm	20,5	81,3	80	105	290	25,0	34,5	10,5	Ø8,5	5	460,60	50

## PLASTİK (VO) TARAK İZOLATÖRLERİ

### 1X2F-1X3F 5-10 mm TARAK İZOLATÖR

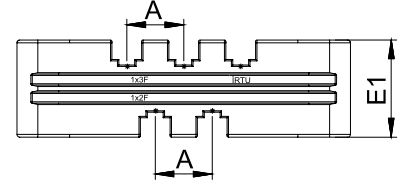
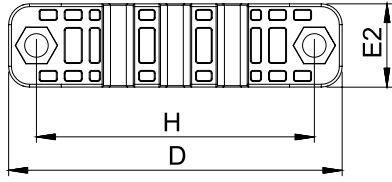

ÜRÜN KODU	TİP	ÖLÇÜLER					MIN	ADET (t)	KUTU ADEDİ
		A	D	H	E1	E2			
PLST1012	1x2F-1x3F/5-10 mm	20,5	120	100	35	30	5	275,70	100

### 1X4F-10 mm TARAK İZOLATÖR (ALTI DÜZ TİP)

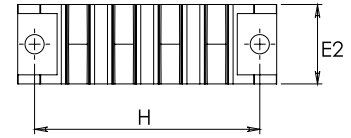
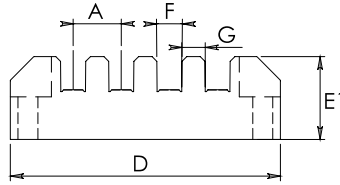

ÜRÜN KODU	TİP	ÖLÇÜLER							MIN	ADET (t)	KUTU ADEDİ
		A	D	F	H	E1	E2	G			
PLST1009	1x4F/10 mm	20,5	115,0	10,5	100,0	35,0	35,00	10,00	5	251,00	80

## GEÇİŞ İZOLATÖR

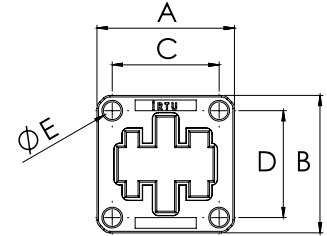

ÜRÜN KODU	TİP	ÖLÇÜLER					MIN	ADET (t)	KUTU ADEDİ
		A	D	C	D	E			
PLST1013	GEÇİŞ İZOLATÖRÜ 20x3 / 20x4 / 30x5 / 30x10	45,0	45,0	35,0	35,0	5,80	5	104,70	100
PLST1014	GEÇİŞ İZOLATÖRÜ 25x5 / 20x10 / 40x10 / 50x10	60,00	60,00	45,00	45,00	6,50	5	136,40	100

### Bushings Properties

Bushings Material:	Glass Reinforced Polyamide 6.6
Conductor Temp:	140°C†
Flamability:	UL94-V0
Equipment Voltage $U_e$ :	690V
Insulation Voltage $U_i$ :	690V
Impulse Voltage $U_{imp}$ :	8kV
Glow Wire:	960°C

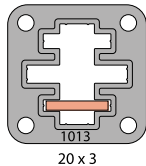

20 x 3

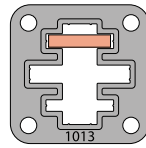

20 x 4

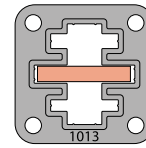

30 x 5

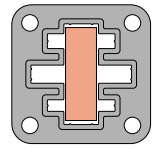

30 x 10

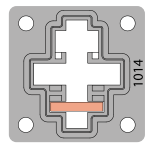

20 x 5

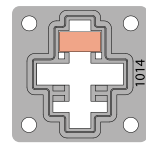

20 x 10

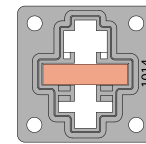

40 x 10

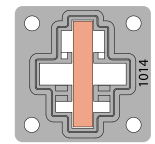

50 x 10

## PROFİL BAĞLANTILI PLASTİK (VO) TARAK İZOLATÖRLERİ

### 1x3F 5 mm TARAK İZOLATÖR

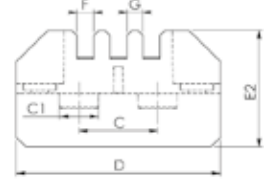
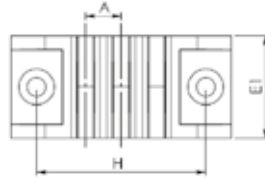

ÜRÜN KODU	TİP	ÖLÇÜLER										MIN	ADET (t)	KUTU ADEDİ
		A	C	C1	D	F	H	E1	E2	G				
PLST1011	1X3F/5 mm	10,5	25,0	8X12,4	65,0	5,5	50,0	30,0	37,0	5,0	5	136,90	100	

ÜRÜN KODU	TİP	KULLANILAN İZOLATÖR ADEDİ	KULLANILAN SAÇ PROFİL UZUNLUĞU	ADET (t)	KUTU ADEDİ
PLST1311	1X3F/5 mm 3 Faz Takım	6	430 mm	5.550,00	1
PLST1411	1X3F/5 mm 3 Faz +N Takım	8	600 mm	6.178,00	1

### 1x4F 5 mm TARAK İZOLATÖR

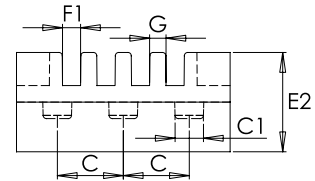
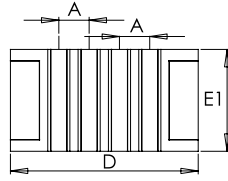
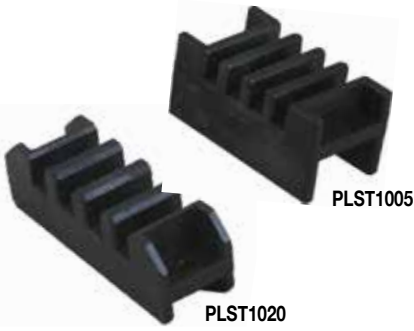

ÜRÜN KODU	TİP	ÖLÇÜLER									MIN (kN)	ADET (t)	KUTU ADEDİ
		A	C	C1	D	F1	E1	E2	G				
PLST1005	1X4F/5 mm	10,5	20,0	8,0	65,0	5,5	35,0	30,0	5,0	5	144,90	100	
PLST1020	1X4F/5 mm	15,5	25,0	12,40	90,0	5,5	24,9	37,0	10,0	-	168,70	100	

ÜRÜN KODU	TİP	KULLANILAN İZOLATÖR ADEDİ	KULLANILAN SAÇ PROFİL UZUNLUĞU	ADET (t)	KUTU ADEDİ
PLST1305	1X4F/5 mm 3 Faz Takım	6	430 mm	5.160,00	1
PLST1405	1X4F/5 mm 3 Faz +N Takım	8	600 mm	6.178,00	1

### 1x2F 10 mm TARAK İZOLATÖR (I:12 / I:9,5 mm)

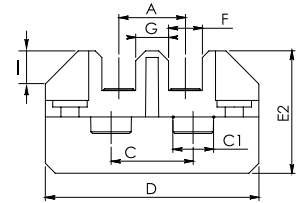
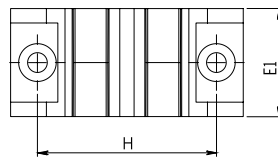

ÜRÜN KODU	TİP	ÖLÇÜLER										MIN	ADET (t)	KUTU ADEDİ
		A	C	C1	D	F	H	E1	E2	G	I			
PLST1007	1X2F/10 mm	20,5	25,0	8X12,4	65,0	10,5	50,0	30,0	37,0	10,0	12	5	113,30	100
PLST1017	1X2F/10 mm	20,5	25,0	8X12,4	65,0	10,5	50,0	30,0	33	10,0	9,5	5	113,30	100

ÜRÜN KODU	TİP	KULLANILAN İZOLATÖR AD.	KULLANILAN SAÇ PROFİL UZUNLUĞU	ADET (t)	KUTU ADEDİ
PLST1307	1X2F/10 mm 3 Faz Takım	6	430 mm	4.844,00	1
PLST1407	1X2F/10 mm 3 Faz +N Takım	8	600 mm	5.832,00	1

## PROFİL BAĞLANTILI PLASTİK (VO) TARAK İZOLATÖRLERİ

1x3F 10 mm TARAK İZOLATÖR (I:12 / I:9,5 mm)

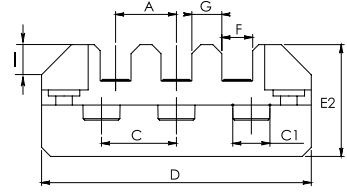
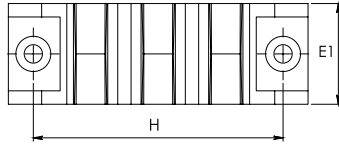

ÜRÜN KODU	TİP	ÖLÇÜLER										MIN	ADET (t)	KUTU ADEDİ
		A	C	C1	D	F	H	E1	E2	G	I			
PLST1008	1X3F/10 mm	20,5	20,0	8X12,4	90,0	10,5	75,0	30,0	37,0	10,0	12,0	5	165,00	100
PLST1018	1X3F/10 mm	20,5	20,0	8X12,4	90,0	10,5	75,0	30	37	10,0	9,5	5	165,00	

ÜRÜN KODU	TİP	KULLANILAN İZOLATÖR AD.	KULLANILAN SAÇ PROFİL UZUNLUĞU	ADET (t)	KUTU ADEDİ
PLST1308	1X3F/10 mm 3 Faz Takım	6	575 mm	5.843,00	1
PLST1408	1X3F/10 mm 3 Faz +N Takım	8	675 mm	6.805,00	1

## 1x4F 10 mm TARAK İZOLATÖR

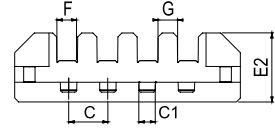
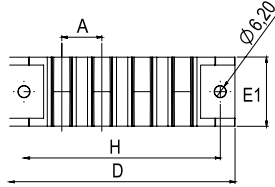

ÜRÜN KODU	TİP	ÖLÇÜLER										MIN	ADET (t)	KUTU ADEDİ
		A	C	C1	D	F	H	E1	E2	G				
PLST1006	1X4F/10 mm	20,5	20,0	8X12,4	115,0	10,5	100,0	35,0	35,0	10,0	5	210,00	100	

ÜRÜN KODU	TİP	KULLANILAN İZOLATÖR ADEDİ	KULLANILAN SAÇ PROFİL UZUNLUĞU	ADET (t)	KUTU ADEDİ
PLST1306	1X4F/10 mm 3 Faz Takım	6	575 mm	6.650,00	1
PLST1406	1X4F/10 mm 3 Faz +N Takım	8	675 mm	7.156,00	1

## 1x3F 10 mm TARAK İZOLATÖR

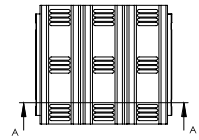
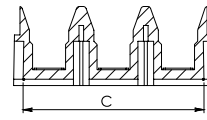
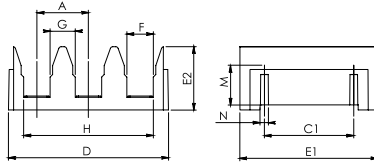

ÜRÜN KODU	TİP	ÖLÇÜLER											MIN	ADET (t)	KUTU ADEDİ
		A	D	F	H	E1	E2	G	C	C1	N	M			
PLST1010	1X3F/10 mm	21,0	69,6	10,5	51,5	55,0	25,0	10,0	63,0	35,5	3,35	15,7	5	118,00	100

  

ÜRÜN KODU	TİP	KULLANILAN İZOLATÖR ADEDİ	KULLANILAN SAÇ PROFİL UZUNLUĞU	ADET (t)	KUTU ADEDİ
PLST1310	1X3F/10 mm 3 Faz Takım	6	575 mm	5.499,00	1
PLST1410	1X3F/10 mm 3 Faz +N Takım	8	675 mm	6.316,00	1



## DAHİLİ TİP A.G. MESNET İZOLATÖR (Polyester)

### ÇİFT TARAF SAPLAMALI

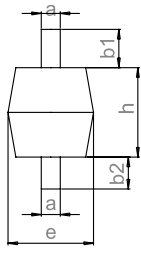

ÜRÜN KODU	TİP	ÖLÇÜLER					Service	Test	Tensile	Ağırlık kg	ADET (t)	KUTU ADEDİ
		a1	b1	b2	e	h						
POLM1001	1NO-S/M5	5	12	12	22	24	0,6	3	0,75	11,00	51,30	500
POLM1002	1N1-S/M6	6	15	15	27	28	0,6	3	1,00	12,00	56,60	300
POLM1003	1NMS-1/M8	8	16	19	40	40	1	3	2,50	10,50	99,30	100
POLM1004	1NMS-2/M10	10	12	15	40	40	1	3	2,70	14,00	120,10	100

### SAPLAMA & KÖR SOMUNLU

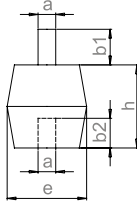

ÜRÜN KODU	TİP	ÖLÇÜLER					Service	Test	Tensile	Ağırlık kg	ADET (t)	KUTU ADEDİ
		a1	b1	b2	e	h						
POLM1005	1NO-K/M5	5	12	12	22	24	0,6	3	0,75	10,50	61,60	500
POLM1006	1N1-K/M6	6	15	15	27	28	0,6	3	1,00	10,80	73,00	300
POLM1007	1NMK-3/M8	8	16	15	40	40	1	3	2,50	9,80	114,40	100
POLM1008	1NMK-2/M10	10	15	15	40	40	1	3	2,70	11,40	136,00	100

### ÇİFT TARAF KÖR SOMUNLU

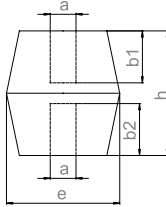

ÜRÜN KODU	TİP	ÖLÇÜLER					Service	Test	Tensile	Ağırlık kg	ADET (t)	KUTU ADEDİ
		a1	b1	b2	e	h						
POLM1009	1NO-KK/M5	5	9	9	22	24	0,6	3	0,75	10,00	112,10	500
POLM1010	1N1-KK/M6	6	12	12	27	28	0,6	3	1,00	9,90	116,30	300
POLM1011	1NMK-4/M8	8	15	15	40	40	1	3	2,50	8,80	151,00	100
POLM1012	1NMK-1/M10	10	15	15	40	40	1	3	2,70	8,90	151,20	100

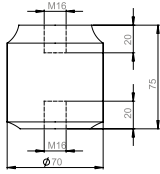

ÜRÜN KODU	TİP	Service	Test	Tensile	Ağırlık kg	ADET (t)	KUTU ADEDİ
POLM1013	1NMD-1	3	20	6,00	9,00	556,00	18

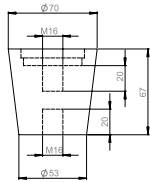

ÜRÜN KODU	TİP	Service	Test	Tensile	Ağırlık kg	ADET (t)	KUTU ADEDİ
POLM1014	1NMA-2	3	15	5,5	6,65	500,30	18

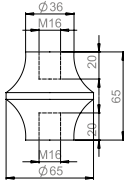

ÜRÜN KODU	TİP	Service	Test	Tensile	Ağırlık kg	ADET (t)	KUTU ADEDİ
POLM1015	1NMC-3	3	15	5,00	4,60	456,70	18

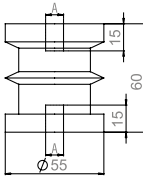

ÜRÜN KODU	TİP	Service	Test	Tensile	Ağırlık kg	ADET (t)	KUTU ADEDİ
POLM1016	1N500	M8	3	15	5,00	231,90	32
POLM1017	1N500	M10	3	15	5,00	234,50	32
POLM1018	1N500	M12	3	15	5,00	248,80	32

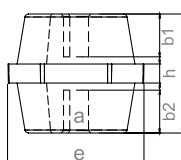

ÜRÜN KODU	TİP	ÖLÇÜLER					Service	Test	Tensile	Ağırlık kg	ADET (t)	KUTU ADEDİ
		a1	b1	b2	e	h						
POLM303006	1NMK-5/M8	6	11	11	30	30	1	3	4	6,00	124,70	100
POLM303008	1NMK-6/M10	8	11	11	30	30	1	3	6	6,20	126,40	100
POLM303010	1NMK-7/M12	10	11	11	30	30	1	3	6	6,50	137,20	100
POLM1019	1NMK-5/M8	8	15	15	50	50	1	3	9	20,00	174,00	100
POLM1020	1NMK-6/M10	10	15	15	50	50	1	3	9	21,00	181,40	100
POLM1021	1NMK-7/M12	12	15	15	50	50	1	3	10	22,00	206,70	100

## DAHİLİ TİP A.G. TARAK İZOLATÖR (Polyester)

### 3x1F TARAK İZOLATÖR

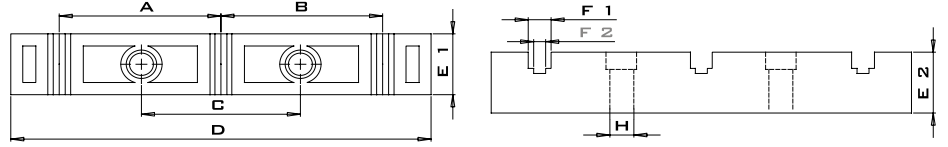

ÜRÜN KODU	TİP	ÖLÇÜLER									Min kN	ADET (t)	KUTU ADEDİ
		A	B	C	D	E1	E2	F1	F2	H			
POLT1002	3x1F/5-10 mm	74,5	74,5	73	193	30	30	10,5	5,5	Ø11	5	229,70	40

### 3x1F TARAK İZOLATÖR

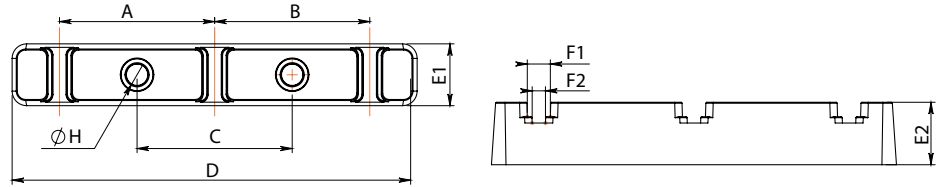

ÜRÜN KODU	TİP	ÖLÇÜLER									Min kN	ADET (t)	KUTU ADEDİ
		A	B	C	D	E1	E2	F1	F2	H			
POLT1012	3x1F/5-10 mm	74	74	74	193	30	30	6	11	Ø9,5	5	143,80	40

### 3x2F TARAK İZOLATÖR

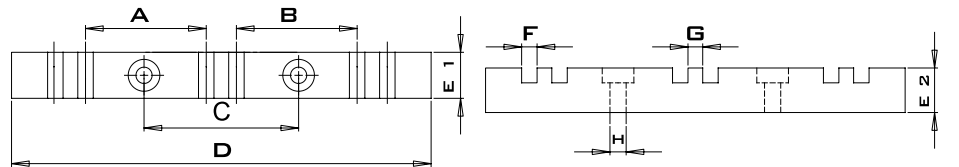
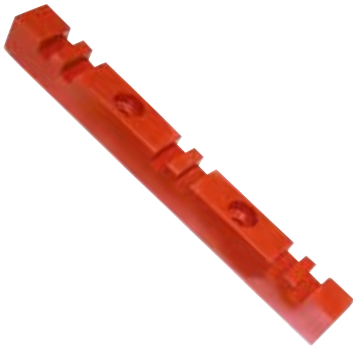

ÜRÜN KODU	TİP	ÖLÇÜLER									Min kN	ADET (t)	KUTU ADEDİ
		A	B	C	D	E1	E2	F1	F2	H			
POLT1007	3x2F/10 mm	82	82	105	285	31	30	10,5	10	Ø11	5	279,60	50
POLT1008	3x2F/5 mm	91,5	91,5	105	285	31	30	5,5	5	Ø11	5		50

### 3x1F+N TARAK İZOLATÖR

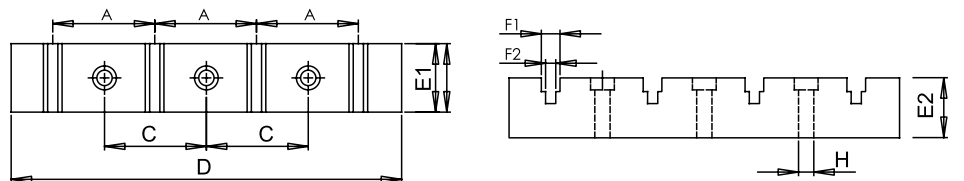

ÜRÜN KODU	TİP	ÖLÇÜLER								Min kN	ADET (t)	KUTU ADEDİ
		A	C	D	E1	E2	F1	F2	H			
POLT1005	3x1F+N/5-10 mm	60	60	230	40	34,5	10,5	5,5	Ø9	5	173,40	32

## DAHİLİ TİP A.G. TARAK İZOLATÖR (Polyester)

### 3x2F TARAK İZOLATÖR

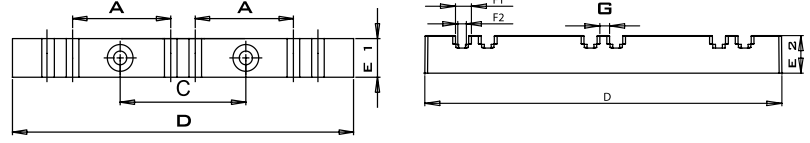

ÜRÜN KODU	TİP	ÖLÇÜLER								Min kN	ADET (t)	KUTU ADEDİ
		A	C	D	E1	E2	F1	F2	H			
POLT1015	3x2F/5-10 mm	82	105	285	31	30	10,5	5,5	Ø11	5	223,70	50

### 3x1F+N TARAK İZOLATÖR

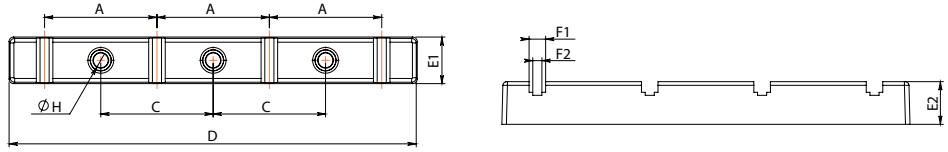

ÜRÜN KODU	TİP	ÖLÇÜLER								Min kN	ADET (t)	KUTU ADEDİ
		A	C	D	E1	E2	F1	F2	H			
POLT1013	3x1F+N/5-10 mm	74	74	269	30	28	11	6	Ø9,5	5	182,60	50

### 1x4F TARAK İZOLATÖR

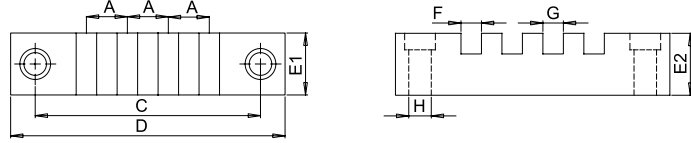

ÜRÜN KODU	TİP	ÖLÇÜLER								Min kN	ADET (t)	KUTU ADEDİ
		A	C	D	E1	E2	F1	F2	H			
POLT1004	1x4F/5 mm	22	110	134	31	29	5,5	10,5	Ø9	5	151,00	50
POLT1001	1x4F/10 mm	22	110	134	31	29	10,5	10,5	Ø9	5	162,10	50

### 3x1FK TARAK İZOLATÖR

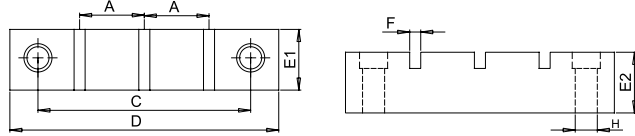
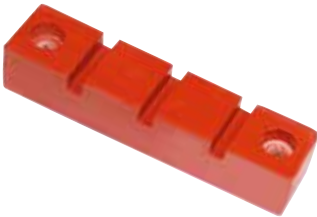

ÜRÜN KODU	TİP	ÖLÇÜLER								Min kN	ADET (t)	KUTU ADEDİ
		A	C	D	E1	E2	F1	F2	H			
POLT1003	3x1FK/5 mm Bakır	33	110	134	31	29	5,5	27	Ø9	5	142,90	50

### 3x2F + N TARAK İZOLATÖR

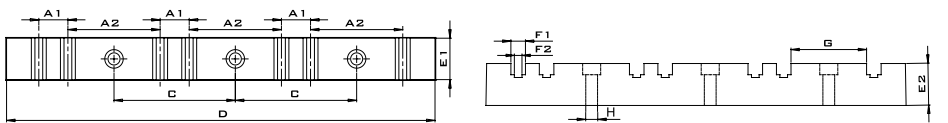
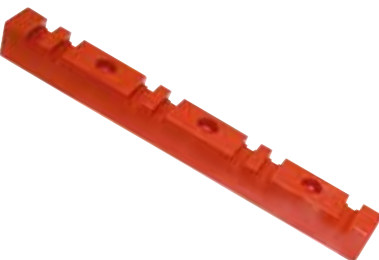

ÜRÜN KODU	TİP	ÖLÇÜLER								Min kN	ADET (t)	KUTU ADEDİ	
		A1	A2	C	D	E1	E2	F1/F2	G				H
POLT1009	3x2F+N/5-10 mm	20,5	65	85,5	303	31	30	10,5/5,5	54,5	Ø8,5	5	483,00	50

## DAHİLİ TİP A.G. TARAK İZOLATÖR (Polyester)

### 3x3F TARAK İZOLATÖR

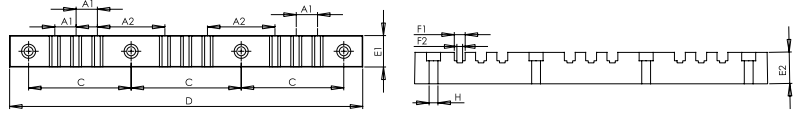

ÜRÜN KODU	TİP	ÖLÇÜLER											Min kN	ADET (t)	KUTU ADEDİ
		A1	A2	C1	C2	D	E1	E2	F1	F2	G	H			
POLT1010	3x3F/5-10 mm	20,5	65	98,75	106	340	30	30	10,5	5,5	10	Ø8,5	5	555,00	20

### 3x1FY+N TARAK İZOLATÖR

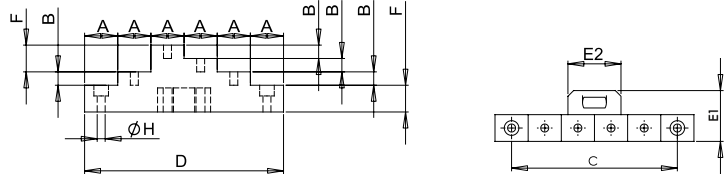

ÜRÜN KODU	TİP	ÖLÇÜLER								Min kN	ADET (t)	KUTU ADEDİ
		A	B	C	D	E1	E2	F	H			
POLT1006	3x1FY + N	25	10	125	150	38	40	20	Ø6	5	291,90	26

## İZOLATÖR (Polyester)

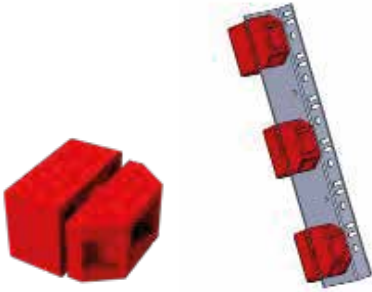

Dikeyde veya yatayda bakırları taşımak için kullanılır. İzolatörler, bağlantı mesafelerine göre birbirinden bağımsız uygulanabilir. İzolatörler, ana şaseye sac parça ile monte edilir.

ÜRÜN KODU	TİP	Kullanım V. ~kV	Test V. ~kV	Gerilim Direnci kN	Ağırlık (gr)	ADET (t)	KUTU ADEDİ
POLM203858	H: 20mm	31	55	5.000	0,150	341,00	50
POLM303858	H: 30mm	31	55	5,00	0,175	365,50	50

## BARA TUTUCU SERFİL



ÜRÜN KODU	CİNSİ	ADET (t)	KUTU ADEDİ
EMTİ-M8-M10	SERFİL	100	100

## EŞ POTANSİYEL BARA



ÜRÜN KODU	CİNSİ	ADET (t)	KUTU ADEDİ
İR-303250	30 x 3 25 cm 7 Delik	100	1
İR-303300	30 x 3 30 cm 10 Delik		1
İR-305300	30 x 5 30 cm 7 Delik		1
İR-305400	30 x 5 40 cm 9 Delik		1
İR-305500	30 x 5 50 cm 12 Delik		1

## ASKI APARATI



ÜRÜN KODU	AÇIKLAMA	ADET (t)	KUTU ADEDİ
İR-7001	80'lik Kablo Taşıma Askısı	204,40	50

## KÖRÜK



ÜRÜN KODU	AÇIKLAMA	ADET (t)	KUTU ADEDİ
İRPKT-1050	Gırtlaklı Körük / 180 x 64	218,40	60
İRPKT-1050V	Gırtlaklı Körük / 180 x 64 V0	339,30	60

\* Orta gerilim hücre içinde kablo girişlerinde sızdırmalara karşı kullanılır.

## ORTA GERİLİM HÜCRE KABLO KÖRÜĞÜ



ÜRÜN KODU	AÇIKLAMA	ADET (t)	KUTU ADEDİ
İRPKT-1040	Ø60 Plastik Kablo Tutucu	89,90	100
İRPKT-1030	Ø100 Plastik Kablo Tutucu	107,80	120

## ORTA GERİLİM HÜCRE KABLO TUTUCU



\* Orta gerilim hücre içinde kablo girişlerinde kullanılır.  
\* Yanmaz ve halogen-free özelliğindedir.  
\* Ø 50-80 mm kabloya uygundur.

ÜRÜN KODU	AÇIKLAMA	ADET (t)	KUTU ADEDİ
İRPKT-1020	PLASTİK KABLO TUTUCU	170,60	100

## TIRNAKLI KROŞELER (PLASTİK)

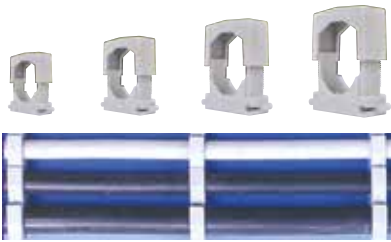

ÜRÜN KODU	AÇIKLAMA	ADET (t)	KUTU ADEDİ
İR-5155	No. 1 Tırnaklı Kroşe 2 x 1.5 / 2 x 2.5 / 2 x 4 / 2 x 6 / 3 x 1.5 / 4 x 1.5 / 3 x 2.5 / 4 x 2.5	33,70	100
İR-5156	No. 2 Tırnaklı Kroşe 4 x 4 / 4 x 6	41,20	100
İR-5157	No. 3 Tırnaklı Kroşe 4 x 10 NYM / 3 x 16 + 10 NYY	44,00	100
İR-5158	No. 4 Tırnaklı Kroşe 3 x 25 + 16 / 3 x 35 + 16 / 3 x 50 + 25 NYY	45,50	25

## BORU / KABLO SABİTLEYİCİLER ve BAĞLANTI RAYLARI



ÜRÜN KODU	AÇIKLAMA	ADET (t)	KUTU ADEDİ
İR-9001	BORU VE KABLO SABİTLEYİCİSİ (8-36)	31,50	750
İR-9002	BORU VE KABLO SABİTLEYİCİSİ (14-48)	132,00	250
İR-9003	BORU VE KABLO SABİTLEYİCİSİ (24-72)	232,00	250

## BORU / KABLO BAĞLANTI RAYLARI



ÜRÜN KODU	AÇIKLAMA	ADET (t)	KUTU ADEDİ
İRMR-9001	GALVANİZ RAY (8-36) (2 mt)	100	100
İRMR-9002	GALVANİZ RAY (14-48 / 24-72) (2 mt)	100	100

## KABLO GEÇİŞ PLAKASI

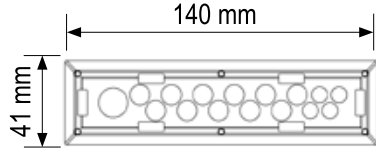

ÜRÜN KODU	ÜRÜN TANIMI	ÖLÇÜLER	ADET (t)	KUTU ADEDİ
KGC4114	Plastik Çerçeve	41x140mm	86,20	25

ÜRÜN KODU	ÜRÜN TANIMI	ÖLÇÜLER	KABLO GEÇİŞ ÖLÇÜLERİ	ADET (t)	KUTU ADEDİ
KCP0010	Conta Plakası	35x133mm	16 x Ø6,5mm 4 x Ø8,5mm 1 x Ø12mm	78,50	25
KCP0011	Conta Plakası	35x133mm	4 x Ø6,5mm 11 x Ø8,5mm 1 x Ø12mm	78,50	25

## UPGM 203 CAM ELYAF PLAKALAR



ÜRÜN KODU	AÇIKLAMA	ÖLÇÜLER (mm)			ADET (t)
		Kalınlık	En	Boy	
İRCEP038001200	Cam Elyaf Polyester Plaka	3	800	1200	☎
İRCEP058001200		5	800	1200	
İRCEP108001200		10	800	1200	
İRCEP158001000		15	800	1200	
İRCEP208001200		20	800	1200	
İRCEP258001200		25	800	1200	
İRCEP308001200		30	800	1200	
İRCET030301200	Cam Elyaf Polyester Takoz	3	30	1200	☎
İRCET030401200		3	40	1200	
İRCET030501200		3	50	1200	
İRCET030601200		3	60	1200	
İRCET050301200	Cam Elyaf Polyester Takoz	5	30	1200	☎
İRCET050401200		5	40	1200	
İRCET050501200		5	50	1200	
İRCET050601200		5	60	1200	
İRCET100301200	Cam Elyaf Polyester Takoz	10	30	1200	☎
İRCET100401200		10	40	1200	
İRCET100501200		10	50	1200	
İRCET100601200		10	60	1200	
İRCET150301200	Cam Elyaf Polyester Takoz	15	30	1200	☎
İRCET150401200		15	40	1200	
İRCET150501200		15	50	1200	
İRCET150601200		15	60	1200	
İRCET200301200	Cam Elyaf Polyester Takoz	20	30	1200	☎
İRCET200401200		20	40	1200	
İRCET200501200		20	50	1200	
İRCET200601200		20	60	1200	
İRCET250301200	Cam Elyaf Polyester Takoz	25	30	1200	☎
İRCET250401200		25	40	1200	
İRCET250501200		25	50	1200	
İRCET250601200		25	60	1200	
İRCET300301200	Cam Elyaf Polyester Takoz	30	30	1200	☎
İRCET300401200		30	40	1200	
İRCET300501200		30	50	1200	
İRCET300601200		30	60	1200	



### KOLLU PANO KİLİDİ İSPANYOLET MEKANİZMALI

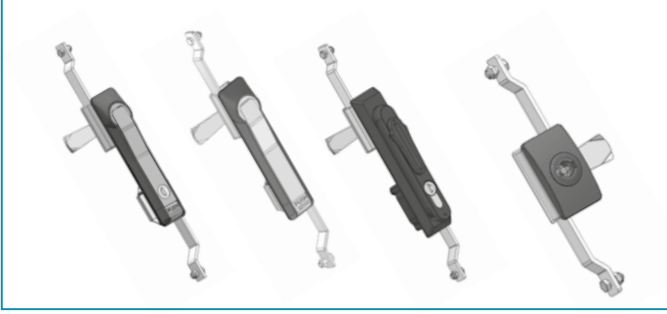

### KABİN KİLİTLERİ

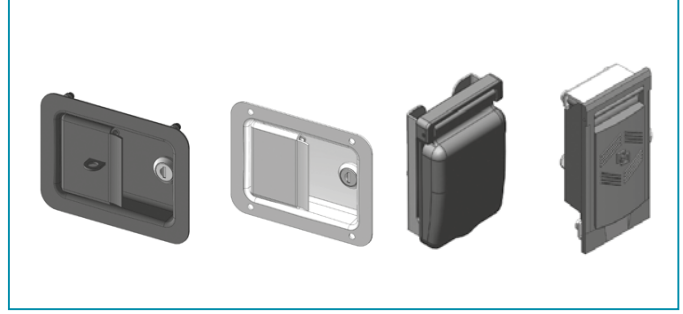

### PANO KİLİTLERİ

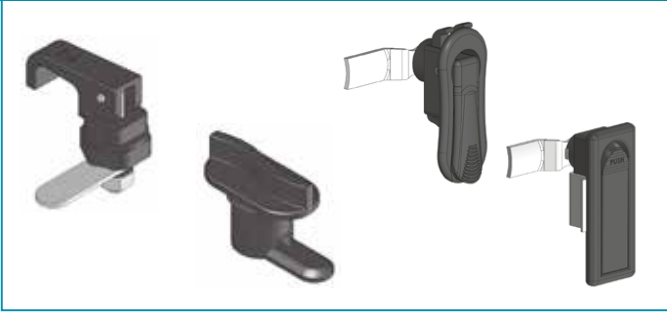

### YAYLI PANO KİLİTLERİ



### ÇEKMECE KİLİTLERİ

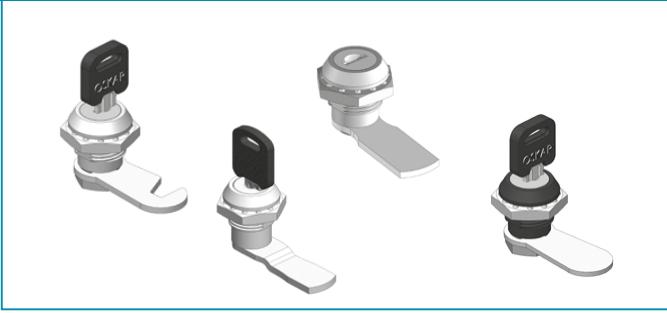

### KÜP MENTEŞELER



### PANO KAPAK MENTEŞELERİ VE YAPRAK MENTEŞELER



### AL.VE PLAST. GEÇMELİ KABİN TOZ FIRÇALARI



### PANO VİDA VE SOMUNLARI



### POLİETİLEN VE EPDM CONTALAR



# Onka®

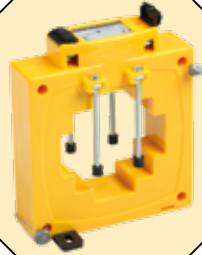

## HAWCON KONDANSATÖR





## AÇILABİLİR AKIM TRANSFORMATÖRLERİ (SCT)

Ürün Tipi	Maks. Bara Kesiti	Ürün Kodu	Primer Akımı	Sekonder Akımı	Sınıf				Anma Gücü					Liste Fiyatı (\$)	
					0,2	0,5	1	3	1,5	2,5	5	10	15		30
OMR.SCT.41	40x15mm Cu	SCT.4010010	100 A	5 A		◇	◇	◆	◆	◆					42,60 \$
		SCT.4010012	125 A	5 A		◇	◇	◆	◆	◆					43,41 \$
		SCT.4010015	150 A	5 A		◇	◇	◆	◆	◆					44,22 \$
		SCT.4010020	200 A	5 A		◇	◆			◆					45,03 \$
		SCT.4010025	250 A	5 A		◇	◆			◆					45,85 \$
		SCT.4010030	300 A	5 A		◇	◆			◆					46,66 \$
		SCT.4010040	400 A	5 A		◆				◆	◆				47,47 \$
		SCT.4010050	500 A	5 A		◆				◆	◆				48,28 \$
		SCT.4010060	600 A	5 A		◆				◆	◆				49,09 \$
OMR.SCT.61	60x15mm Cu	SCT.6010060	600 A	5 A		◆					◆	◆		52,92 \$	
		SCT.6010075	750 A	5 A		◆					◆	◆		55,44 \$	
		SCT.6010080	800 A	5 A		◆					◆	◆		57,96 \$	
		SCT.6010100	1000 A	5 A		◆					◆	◆		60,48 \$	
OMR.SCT.104	100x40mm Cu	SCT.1040100	1000 A	5 A		◆						◆	◆	71,44 \$	
		SCT.1040120	1200 A	5 A		◆						◆	◆	74,84 \$	
		SCT.1040125	1250 A	5 A		◆						◆	◆	78,25 \$	
		SCT.1040150	1500 A	5 A		◆						◆	◆	81,65 \$	
		SCT.1040160	1600 A	5 A		◆						◆	◆	85,05 \$	
		SCT.1040200	2000 A	5 A		◆						◆	◆	88,45 \$	
		SCT.1040250	2500 A	5 A		◆						◆	◆	91,85 \$	
OMR.SCT.124	120x40mm Cu	SCT.1240200	2000 A	5 A		◆							◆	◆	97,24 \$
		SCT.1240250	2500 A	5 A		◆							◆	◆	101,87 \$
		SCT.1240300	3000 A	5 A		◆							◆	◆	106,50 \$
		SCT.1240320	3200 A	5 A		◆							◆	◆	111,13 \$
		SCT.1240400	4000 A	5 A		◆							◆	◆	115,76 \$

Tabloda yer almayan; primer ve sekonder akımı, sınıf, nominal güç vb. farklı değerlere ve özelliklere sahip ürünler için bizimle iletişime geçiniz.

### Ürün Teknik Ölçüleri ve Özellikleri

	A	B	C	D	F	K
OMR.SCT.41	104	79	54	36	44	16
OMR.SCT.61	124	79	54	36	64	16
OMR.SCT.104	164	105	54	36	104	42
OMR.SCT.124	184	105	54	36	124	42

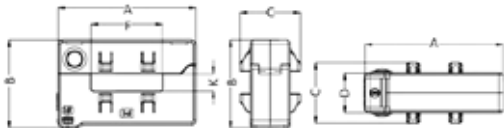



### NEOZED BUŞON / SİGORTA YUVALARI



### AÇMA KAPAMA ŞALTERLERİ



### HIZLI SİGORTALAR



### KADEMELİ ŞALTERLER



### PORSELEN SİGORTALAR



### KUTUP DEĞİŞTİRİCİ ŞALTERLER

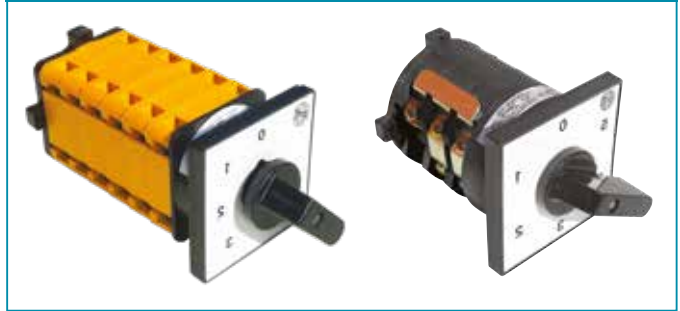

### SOLAR SİGORTA BUŞONU / NORMAL BUŞON



### AYIRICI KESİCİ ŞALTERLER



### NH SİGORTALAR / NH ALTLIK



### MOTOR KUMANDA ŞALT. - ÖLÇME KOMİTATÖRLERİ





## 3 KUTUPLU KONTAKTÖR - BOBİN 230 V AC



ÜRÜN KODU	GÜÇ / AKIM / Y.KONTAK	ADET (\$)
XCN-35091	4 kW, 9 A, 1NO	9,30 \$
XCN-35092	4 kW, 9 A, 1NC	9,30 \$
XCN-35121	5.5 kW, 12 A, 1NO	9,70 \$
XCN-35122	5.5 kW, 12 A, 1NC	9,70 \$
XCN-35181	7.5 kW, 18 A, 1NO	11,00 \$
XCN-35182	7.5 kW, 18 A, 1NC	11,00 \$
XCN-35251	11 kW, 25 A, 1NO	16,00 \$
XCN-35252	11 kW, 25 A, 1NC	16,00 \$
XCN-35321	15 kW, 32 A, 1NO	24,50 \$
XCN-35322	15 kW, 32 A, 1NC	24,50 \$
XCN-35405	18.5 kW, 40 A, 1NO + 1NC	39,00 \$
XCN-35505	22 kW, 50 A, 1NO + 1NC	42,00 \$
XCN-35655	30 kW, 65 A, 1NO + 1NC	45,00 \$
XCN-35805	37 kW, 80 A, 1NO + 1NC	59,00 \$
XCN-35955	45 kW, 95 A, 1NO + 1NC	65,00 \$
XCN-35965	55 kW, 115 A, 1NO + 1NC	132,00 \$
XCN-35975	75 kW, 150 A, 1NO + 1NC	142,00 \$

## TERMİK RÖLE



ÜRÜN KODU	AKIM	ADET (\$)
Kontaktörü: 9-32A		
XTR-31010	0.63 - 1 A	9,50 \$
XTR-31016	1 - 1.6 A	9,50 \$
XTR-31025	1.6 - 2.5 A	9,50 \$
XTR-31040	2.5 - 4 A	9,50 \$
XTR-31060	4 - 6 A	9,50 \$
XTR-31080	5.5 - 8 A	9,50 \$
XTR-31100	7 - 10 A	9,50 \$
XTR-31130	9 - 13 A	9,50 \$
XTR-31180	12 - 18 A	9,50 \$
XTR-31250	17 - 25 A	9,50 \$

## YARDIMCI KONTAK BLOĞU



ÜRÜN KODU	MONTAJ / KONTAK	ADET (\$)
XCN-39211	Üst, 1NO + 1NC	2,50 \$
XCN-39422	Üst, 2NO + 2NC	4,00 \$

## 3 KUTUPLU KONTAKTÖR - BOBİN 230 V AC



ÜRÜN KODU	GÜÇ / AKIM / Y.KONTAK	ADET (\$)
XCN-55095	4 kW, 9 A, 1NO+1NC	12,20 \$
XCN-55125	5,5 kW, 12 A, 1NO+1NC	13,00 \$
XCN-55185	7,5 kW, 18 A, 1NO+1NC	15,00 \$
XCN-55225	11 kW, 25 A, 1NO+1NC	16,00 \$
XCN-55326	15 kW, 32 A, 2NO+2NC	25,00 \$
XCN-55406	18,5 kW, 40 A, 2NO+2NC	26,00 \$
XCN-55506	22 kW, 50 A, 2NO+2NC	50,00 \$
XCN-55656	30 kW, 65 A, 2NO+2NC	52,00 \$
XCN-55756	37 kW, 75 A, 2NO+2NC	55,00 \$
XCN-55856	45 kW, 85 A, 2NO+2NC	58,00 \$
XCN-55996	55 kW, 100 A, 2NO+2NC	72,00 \$



ÜRÜN KODU	AKIM / GÜÇ	ADET (\$)
15 kA		
XMP-10025	1.6 - 2.5 A, 0.75 kW	23,00 \$
XMP-10040	2.5 - 4A, 1.5 kW	23,00 \$
XMP-10063	4 - 6.3 A, 2.2 kW	23,00 \$
XMP-10100	6 - 10 A, 4 kW	23,00 \$
XMP-10140	9 - 14A, 5.5 kW	23,00 \$
XMP-10180	13 - 18 A, 7.5 kW	23,00 \$
XMP-10230	17 - 23 A, 9 kW	24,00 \$
XMP-10250	20 - 25 A, 11 kW	24,00 \$
XMP-10320	24 - 32 A, 15 kW	26,00 \$
Yardımcı Donanım		
XMP-90211	Üst Kontak, NO + NC	4,50 \$
XMP-91211	Yan Kontak, NO + NC	6,00 \$

## YARDIMCI KONTAK BLOĞU



ÜRÜN KODU	MONTAJ / KONTAK	ADET (\$)
XCN-90211	Üst, 1NO + 1NC	5,00 \$
XCN-90422	Üst, 2NO + 2NC	7,20 \$

## 3 KUTUPLU MİNİ KONTAKTÖR



ÜRÜN KODU	GÜÇ / AKIM / Y.KONTAK	ADET (\$)
XCN-15091	230 V AC, 4 kW, 9 A, 1NO	10,50 \$
XCN-15092	230 V AC, 4 kW, 9 A, 1NC	10,50 \$
XCN-17091	24 V AC, 4 kW, 9 A, 1NO	11,80 \$
XCN-17092	24 V AC, 4 kW, 9 A, 1NC	11,80 \$

## OTOMATİK SİGORTA 4.5KA



ÜRÜN KODU	KUTUP / AKIM / TİP	ADET (\$)
<b>1 Kutuplu, C Tipi</b>		
XBC-34116	1 Kutup, 16A, C Tipi	2,10 \$
XBC-34120	1 Kutup, 20A, C Tipi	2,10 \$
XBC-34125	1 Kutup, 25A, C Tipi	2,10 \$
XBC-34132	1 Kutup, 32A, C Tipi	2,10 \$
XBC-34140	1 Kutup, 40A, C Tipi	2,10 \$
XBC-34150	1 Kutup, 50A, C Tipi	2,30 \$
XBC-34163	1 Kutup, 63A, C Tipi	2,30 \$
<b>3 Kutuplu, C Tipi</b>		
XBC-34316	3 Kutup, 16A, C Tipi	7,50 \$
XBC-34320	3 Kutup, 20A, C Tipi	7,50 \$
XBC-34325	3 Kutup, 25A, C Tipi	7,50 \$
XBC-34332	3 Kutup, 32A, C Tipi	7,50 \$
XBC-34340	3 Kutup, 40A, C Tipi	7,50 \$
XBC-34350	3 Kutup, 50A, C Tipi	8,00 \$
XBC-34363	3 Kutup, 63A, C Tipi	8,00 \$



## KAÇAK AKIM KORUMA RÖLESİ



ÜRÜN KODU	AKIM / GÜÇ	ADET (\$)
<b>2 Kutuplu</b>		
XLC-41225	2 x 25A, 30 mA	11,00 \$
XLC-41240	2 x 40A, 30 mA	11,00 \$
XLC-41263	2 x 63A, 30 mA	11,00 \$
XLC-42225	2 x 25A, 300 mA	11,00 \$
XLC-42240	2 x 40A, 300 mA	11,00 \$
XLC-42263	2 x 63A, 300 mA	11,00 \$
<b>4 Kutuplu</b>		
XLC-41425	4 x 25 A, 30 mA	18,00 \$
XLC-41440	4 x 40 A, 30 mA	18,00 \$
XLC-41463	4 x 63 A, 30 mA	18,00 \$
XLC-42425	4 x 25 A, 300 mA	18,00 \$
XLC-42440	4 x 40 A, 300 mA	18,00 \$
XLC-42463	4 x 63 A, 300 mA	18,00 \$



## ZAMAN, KORUMA VE KONTROL RÖLELERİ



ÜRÜN KODU	AÇIKLAMA	ADET (\$)
<b>Zaman Rölesi, Bes.: 12-24-230VAC-DC, Kontak: CO</b>		
RT8-TS106	6sn	15,50 \$
RT8-TS112	12sn	15,50 \$
RT8-TS130	30sn	14,20 \$
RT8-TS160	60sn	14,20 \$
RT8-TS206	6dk	15,50 \$
RT8-TS212	12dk	15,50 \$
RT8-TS230	30dk	16,00 \$
RT8-TS260	60dk	16,00 \$
<b>Özel Zaman Rölesi, Bes.: 12-24-230VAC-DC Kontak: CO</b>		
RTS-TS410	100saat Multi Zaman	18,00 \$
RTS-TF410	100saat/100saat Multi Flaşör	36,00 \$
RTS-TD110	30sn/0.5sn Yıldız-Üçgen	24,30 \$
<b>Faz Koruma Rölesi</b>		
RT8-MP120	%20 Sabit - Faz Yokluğu	14,20 \$
RT8-MP220	%20 Sabit - Faz Yok. / Faz Sır.	15,10 \$
RT8-MP320	%20 Sabit - Faz Yok. / Faz Sır. / PTC	18,50 \$
RT8-MP140	%40 Sabit - Faz Yok.	14,20 \$
RT8-MP240	%40 Sabit - Faz Yok. / Faz Sır.	15,10 \$
RT8-MP340	%40 Sabit - Faz Yok. / Faz Sır. / PTC	18,50 \$
<b>Gerilim Koruma Rölesi Monofaze Nötrlü, Delay: 20/20sn</b>		
RT8-VP110	Vmin: 140-210V/Vmax: 230-300V	26,80 \$
<b>Gerilim Koruma Rölesi, Trifaze Nötrlü</b>		
RT8-VP310	Vmin: 140-210VAC	26,80 \$
RT8-VP311	Vmax: 230-300VAC Faz Yokluğu	28,00 \$
RT8-VP312	Delay: 20sn/20sn Faz Yok./Faz Sır.	30,00 \$
<b>Gerilim Koruma Rölesi, Trifaze Nötrsüz</b>		
RT8-VP300	Vmin: 230-360VAC Faz Yokluğu	26,80 \$
RT8-VP301	Vmax: 230-360VAC Faz Yok./Faz Sır.	28,00 \$
RT8-VP302	Delay: 0.1 - 20sec Faz Yok./Faz Sır./PTC	30,00 \$
<b>Fotosel Rölesi</b>		
RT8-PL110	Lüx Ayarlı	17,20 \$
RT8-PL900	Fotosel Göz	7,10 \$
<b>Sıvı Seviye Rölesi</b>		
RT8-LC110	0-50kOhm	21,20 \$
RT8-LC900	Elektrod	4,20 \$

## LİMİT SWITCH



ÜRÜN KODU	AÇIKLAMA	ADET (\$)
<b>MLP Plastik Gövde</b> (Kontak: NO+NC, 3A/240 V AC, Snap Action)		
MLP-25110	Dikey Pim Kısa	5,50 \$
MLP-25112	Dikey Pim Makara, Ø12 mm, Metal	5,50 \$
MLP-25121	Dikey Pim Düz Kol Mak. Ø12 mm, Metal	5,50 \$
MLP-25129	Dikey Pim, Test Kol, Mak. Ø12 mm, Metal	5,50 \$
MLP-25132	Döner Sabit Kol, Mak. Ø18 mm, Metal	5,50 \$
MLP-25142	Döner Ayarlı Kol, Mak. Ø18 mm, Metal	5,80 \$
MLP-25147	Döner Ayarlı Kol, Mak. Ø50 mm, Kauçuk	5,80 \$
MLP-25157	Döner Ayarlı Uzun Kol, Mak. Ø50 mm, Kauçuk	6,00 \$
MLP-25190	Çok Yönlü Spiral Tel Uç	5,50 \$
MLP-25191	Çok Yönlü Spiral Plastik Uç	5,50 \$
MLP-25212	Resetli Dikey Pim Mak. Ø12 mm, Metal	5,50 \$
MLP-25247	Resetli Döner Ayaklı Kol Makara Ø50 mm, Kauçuk	6,60 \$
MLP-25257	Resetli Döner Ayaklı Uzun Kol Makara Ø50 mm, Kauçuk	6,80 \$
<b>MLM Metal Gövde</b> (Kontak: NO+NC, 3A/240 V AC, Snap Action)		
MLM-25110	Dikey Pim Kısa	15,00 \$
MLM-25112	Dikey Pim Mak. Ø12 mm, Metal	15,00 \$
MLM-25121	Dikey Pim Kol Mak. Ø20 mm, Metal	15,00 \$
MLM-25132	Döner Sabit Kol Mak. Ø18 mm, Metal	15,00 \$
MLM-25142	Döner Ayarlı Kol Mak. Ø18 mm, Metal	15,60 \$
MLM-25147	Döner Ayarlı Kol Mak. Ø50 mm, Kauçuk	15,60 \$
MLM-25190	Çok Yönlü Spiral Tel Uç	15,00 \$
MLM-25191	Çok Yönlü Spiral Plastik Uç	15,00 \$

## MİKRO SWITCH



ÜRÜN KODU	AÇIKLAMA	ADET (\$)
MDX-15311	Mikro Switch Contalı	8,00 \$
MTX-16102	Toggle Switch On-On 3 Pin	3,00 \$
MTX-16103	Toggle Switch On-Off-On 3 Pin	3,00 \$

## MİKRO SWITCH



ÜRÜN KODU	AÇIKLAMA	ADET (\$)
<b>Bakalit Gövde, Vidalı Terminal</b> (Kontak: CO, 15A/250 V AC, Snap Action)		
MGB-51300	Kısa İnce Pim	3,60 \$
MGB-51305	Uzun İnce Pim	3,60 \$
MGB-51306	Kısa Pim	3,60 \$
MGB-51307	Düz Pim	4,20 \$
MGB-51308	Düz Makaralı Pim	4,40 \$
MGB-51318	Ters Makaralı Pim	4,40 \$
MGB-51701	Klasik Palet	3,60 \$
MGB-51791	Uzun Palet	3,60 \$
MGB-51704	Makaralı, Kısa Palet	3,60 \$
MGB-51703	Makaralı Palet	3,60 \$
MGB-51744	Kırmalı Makaralı, Kısa Palet	4,20 \$
<b>Switch Kılıfı</b>		
MGB-80000	Plastik Kılıf Düz	0,60 \$
MGB-90000	Kauçuk Kılıf 45° Eğik Kablo Çıkışlı	0,60 \$

## MİKRO SWITCH



ÜRÜN KODU	AÇIKLAMA	ADET (\$)
<b>Terminal : 6.3 x 0.8 mm</b> (Kontak: CO, 16A/250 V AC)		
KW3-OZ	Pimli	1,70 \$
KW3-OZ1	Metal Makaralı Palet	1,70 \$
KW3-OZ2	Çengel Uçlu Palet	1,70 \$
KW3-OZ3	Düz Palet	1,70 \$
KW3-OZ6	Metal Makaralı, Kısa Palet	1,70 \$
KW3-OZ7	Uzun Palet	1,70 \$

**MB3 Ø22 PLASTİK BUTON**

ÜRÜN KODU	AÇIKLAMA / KONTAK	ADET (\$)
<b>Yaylı Buton, 3A/250VAC</b>		
MB3-EA210	Siyah / NO	1,10 \$
MB3-EA310	Yeşil / NO	1,10 \$
MB3-EA420	Kırmızı / NC	1,10 \$
MB3-EA510	Sarı / NO	1,10 \$
MB3-EA610	Mavi / NO	1,10 \$
<b>İşaretli Yaylı Buton, 3A/250VAC</b>		
MB3-EA112	Beyaz (→) / NO	1,20 \$
MB3-EA212	Siyah (→) / NO	1,20 \$
MB3-EA514	Sarı Alarm / NO	1,20 \$
MB3-EA613	Mavi (↔) / NO	1,20 \$
<b>Acil Stop Kalıcı Mantar Buton, 3A/250VAC</b>		
MB3-ES442	Bas-Çevir 030 / NC	1,70 \$
MB3-ES542	Bas-Çevir 040 / NC	1,70 \$
MB3-ES642	Bas-Çevir 060 / NC	3,20 \$
MB3-ES142	Anahtarlı 040 / NC	3,30 \$
MB3-EC420	Kırmızı / NC	1,80 \$
<b>İkiz Buton, 3A/250VAC</b>		
MB3-EA845	İşıksız / NO+NC	2,70 \$
MB3-EW845	İşikli / NO+NC	3,60 \$
<b>Kısa Mandal Buton, 3A/250VAC, ( ): Yaylı Poz.</b>		
MB3-ED210	0-1 / NO	1,30 \$
MB3-ED410	0-(1) / NO	1,50 \$
MB3-ED330	1-0-2 / 2NO	1,90 \$
MB3-ED530	(1)-0-(2) / 2NO	2,10 \$
<b>İşikli Yaylı Buton, Ba9S Neon, 220VAC 3A/250VAC</b>		
MB3-EW611	Beyaz / NO	2,30 \$
MB3-EW631	Yeşil / NO	2,30 \$
MB3-EW642	Kırmızı / NC	2,30 \$
MB3-EW651	Sarı / NO	2,30 \$
MB3-EW661	Mavi / NO	2,30 \$
<b>Ø22 Anahtarlı Buton, 3A/250VAC, ( ): Yaylı Poz. X: Anahtar Çıkamaz</b>		
MB3-EG210	0-1 / NO	2,80 \$
MB3-EG410	0-1 / NO	2,80 \$
MB3-EG610	0-(1) / NO	2,80 \$
MB3-EG330	1-0-2 / 2NO	3,40 \$
MB3-EG030	1-0-2 / 2NO	3,40 \$
MB3-EG730	(1)-0-(2) / 2NO	3,40 \$
<b>Kontak Bloğu, 3A/250VAC</b>		
MB1-ZB101	NO Buton için	0,60 \$
MB1-ZB102	NC Buton için	0,60 \$

**MB5 Ø22 PLASTİK BUTON**

ÜRÜN KODU	AÇIKLAMA / KONTAK	ADET (\$)
<b>Yaylı Buton</b>		
MB5-EA210	Siyah / NO	2,00 \$
MB5-EA310	Yeşil / NO	2,00 \$
MB5-EA420	Kırmızı / NC	2,00 \$
MB5-EA510	Sarı / NO	2,00 \$
MB5-EA610	Mavi / NO	2,00 \$
<b>Mandal Buton</b>		
MB5-ED210	0-1 / NO	2,30 \$
MB5-ED410	0-(1) / NO	2,50 \$
MB5-ED330	1-0-2 / 2NO	3,10 \$
MB5-ED530	(1)-0-(2) / 2NO	3,30 \$
<b>Mandal Buton, 0-1 Ledli 230VAC</b>		
MB5-EK711	Beyaz / NO	3,70 \$
MB5-EK731	Yeşil / NO	3,70 \$
MB5-EK741	Kırmızı / NO	3,70 \$
MB5-EK751	Sarı / NO	3,70 \$
MB5-EK761	Mavi / NO	3,70 \$
<b>Acil Stop Butonu, Bas-Çevir</b>		
MB5-ES542	İşıksız / NC	2,70 \$
MB5-ES562	Led 230VAC / NC	4,40 \$
<b>Yaylı Mantar Buton</b>		
MB5-EC310	Yeşil / NO	2,40 \$
MB5-EC420	Kırmızı / NC	2,40 \$
MB5-EC510	Sarı / NO	2,40 \$
<b>İkiz Buton</b>		
MB5-EA845	İşıksız / NC	3,80 \$
MB5-EW945	Led 230VAC / NC	5,20 \$
<b>Yaylı Buton Ledli, 230VAC</b>		
MB5-EW711	Beyaz / NO	3,70 \$
MB5-EW731	Yeşil / NO	3,70 \$
MB5-EW742	Kırmızı / NC	3,70 \$
MB5-EW751	Sarı / NO	3,70 \$
MB5-EW761	Mavi / NO	3,70 \$
<b>Anahtarlı Buton, 230VAC, (-): Yaylı Poz., [-]: Anahtar Çıkamaz</b>		
MB5-EG210	0-[1] / NO	3,60 \$
MB5-EG410	0-1 / NO	3,60 \$
MB5-EG610	0-(1) / NO	3,60 \$
MB5-EG330	[1]-0-[2] / 2NO	4,40 \$
MB5-EG030	1-0-2 / 2NO	4,40 \$
MB5-EG730	(1)-0-(2) / 2NO	4,40 \$
<b>Kontak Bloğu, 3A/250VAC</b>		
MB5-ZB101	NO	0,80 \$
MB5-ZB102	NC	0,80 \$

## MB3 Ø22 METAL BUTON

ÜRÜN KODU	AÇIKLAMA / KONTAK	ADET (\$)
<b>Yaylı Buton, 3A/250VAC</b>		
MB3-BA210	Siyah / NO	1,50 \$
MB3-BA310	Yeşil / NO	1,50 \$
MB3-BA420	Kırmızı / NC	1,50 \$
MB3-BA510	Sarı / NO	1,50 \$
MB3-BA610	Mavi / NO	1,50 \$
<b>Acil Stop ve Mantar Buton, 3A/250VAC</b>		
MB3-BS542	Bas - Çevir / NC	2,50 \$
MB3-BC420	Yaylı / NC	2,50 \$
MB3-BS142	Anahtarlı / NC	4,20 \$
<b>Mandal Buton, 3A/250VAC</b>		
MB3-BD210	0-1 NO	1,80 \$
MB3-BD330	1-0-2 / 2 NO	2,40 \$
<b>Işıklı Yaylı Buton, Işık : 220VAC, Ba9S Neon 3A/250VAC</b>		
MB3-BW611	Beyaz / NO	3,10 \$
MB3-BW631	Yeşil / NO	3,10 \$
MB3-BW642	Kırmızı / NC	3,10 \$
MB3-BW651	Sarı / NO	3,10 \$
MB3-BW661	Mavi / NO	3,10 \$
<b>İkiz Buton, 3A/250VAC</b>		
MB3-BA845	Işıksız / NO+NC	2,90 \$
MB3-BW845	Işıklı / NO+NC	3,80 \$
<b>Anahtarlı Buton, 3A/250VAC, X: Anahtar Çıkmaz</b>		
MB3-BG210	0 -1 / NO	3,60 \$
MB3-BG330	0-1-2 / NO	4,20 \$

## Ba9S LED AMPULLER

ÜRÜN KODU	AÇIKLAMA	ADET (\$)
Ba9S Led Amp.	12V / 24V / 110V / 230V	1,60 \$

## Ø22 LED SİNYAL LAMBASI



ÜRÜN KODU (230V)	ÜRÜN KODU (24V)	RENK	ADET (\$)
MB3-EV916	MB3-EV917	Beyaz	0,68 \$
MB3-EV936	MB3-EV937	Yeşil	0,68 \$
MB3-EV946	MB3-EV947	Kırmızı	0,68 \$
MB3-EV956	MB3-EV957	Sarı	0,68 \$
MB3-EV966	MB3-EV967	Mavi	0,68 \$

## Ø22 VOLTMETRE SİNYAL LAMBASI (12-500V)



ÜRÜN KODU	AÇIKLAMA	ADET (\$)
MB3-EV516	Beyaz	2,40 \$
MB3-EV536	Yeşil	2,40 \$
MB3-EV546	Kırmızı	2,40 \$
MB3-EV556	Sarı	2,40 \$
MB3-EV566	Mavi	2,40 \$

## Ø22 AMPERMETRE SİNYAL LAMBASI (0-100A)



ÜRÜN KODU	AÇIKLAMA	ADET (\$)
MB3-EV616	Beyaz	4,50 \$
MB3-EV636	Yeşil	4,50 \$
MB3-EV646	Kırmızı	4,50 \$
MB3-EV656	Sarı	4,50 \$
MB3-EV666	Mavi	4,50 \$

## Ø22 VOLT-AMPER SİNYAL LAMBASI



Voltaj: 12-500V  
Akım: 0-100A

ÜRÜN KODU	AÇIKLAMA	ADET (\$)
MB3-EV716	Beyaz	7,50 \$
MB3-EV736	Yeşil	7,50 \$
MB3-EV746	Kırmızı	7,50 \$
MB3-EV756	Sarı	7,50 \$
MB3-EV766	Mavi	7,50 \$

## Ø22 KARE VOLT-AMPER-FREKANS SİNYAL LAMBASI



Voltaj: 12-500V  
Akım: 0-100A  
Frekans: 0-99Hz

ÜRÜN KODU	AÇIKLAMA	ADET (\$)
MB3-EV816	Beyaz	10,50 \$
MB3-EV836	Yeşil	10,50 \$
MB3-EV846	Kırmızı	10,50 \$
MB3-EV856	Sarı	10,50 \$
MB3-EV866	Mavi	10,50 \$



## POTANSİYOMETRE



ÜRÜN KODU	AÇIKLAMA	ADET (\$)
<b>Ø22 Tek Tur Potansiyometre</b>		
MPT-21001	1 kOhm	4,50 \$
MPT-21002	2.2 kOhm	4,50 \$
MPT-21005	5 kOhm	4,50 \$
MPT-21010	10 kOhm	4,50 \$

## SAYICI



ÜRÜN KODU	AÇIKLAMA	ADET (\$)
<b>Mekanik Sayıcı-Resetli-Kilitli, Montaj: 48x24mm</b>		
MCN-11605	220 VAC / 6 Hane	21,00 \$
MCN-11607	24 VDC / 6 Hane	21,00 \$
<b>Mekanik Sayıcı-Resetli-Kilitli, Montaj: 48x24mm</b>		
MCN-12605	220VAC / 6 Hane	21,00 \$
MCN-12607	24 VDC / 6 Hane	21,00 \$
<b>Dijital Sayıcı-Resetli, Montaj: 48x24mm</b>		
MCN-22605	220VAC / 6 Hane	24,00 \$
MCN-22607	24 VDC / 6 Hane	24,00 \$
<b>İş Güç Zaman Saati, 48x48mm</b>		
MCN-48825	220VAC / 7 Hane	11,00 \$

## SICAKLIK KONTROL CİHAZI



ÜRÜN KODU	AÇIKLAMA	ADET (\$)
STC-1000	-50°C / 99°C	21,00 \$

## DİJİTAL ÖLÇÜ ALETLERİ



ÜRÜN KODU	FONK. / V / A / FREKANS	ADET (\$)
<b>72x72mm Panelmetre</b>		
DPM-71000	V, 500 VAC	20,00 \$
DPM-72000	A, 10A Direk	24,00 \$
DPM-73000	A, 100A A.Trafo	24,00 \$
DPM-75000	V A, 500VAC, 100A A.Trafo	32,00 \$
DPM-77000	V A Hz, 500VAC, 100A A.Trafo, 99Hz	36,00 \$
<b>96x96mm Panelmetre</b>		
DPM-91000	V, 500 VAC	22,00 \$
DPM-92000	A, 10A Direk	26,00 \$
DPM-93000	A, 100A A.Trafo	26,00 \$
DPM-95000	V A, 500VAC, 100A A.Trafo	34,00 \$
DPM-97000	V A Hz, 500VAC, 100A A.Trafo, 99Hz	38,00 \$

## Ø22 BUZZER



ÜRÜN KODU	AÇIKLAMA	ADET (\$)
MB3-EB164	220V Ledli	2,60 \$
MB3-EB174	24V Ledli	2,60 \$

## SİREN VE BUZZER



ÜRÜN KODU	AÇIKLAMA	ADET (\$)
<b>Ø30 Buzzer Tek Ton</b>		
MSS-31024	24VAC/DC	6,80 \$
MSS-31220	220VAC	6,80 \$
<b>Ø30 Buzzer Çift Ton</b>		
MSS-32024	12-24VAC/DC	7,90 \$
MSS-32220	220VAC	7,90 \$
<b>Ø75 Motorlu Siren, Metal Gövde</b>		
MSS-76012	12VDC	12,00 \$
MSS-76024	24VDC	12,00 \$
MSS-76110	110VAC	12,00 \$
MSS-76220	220VAC	12,00 \$
<b>Elektronik Buzzer</b>		
MSS-55012	Elektronik 12V	5,00 \$

## AKSİYEL FAN



ÜRÜN KODU	VOLTAJ / TİP	ADET (\$)
<b>120x120x38mm Kare Fan</b>		
MFX-12038-HSPQ-5	230VAC, Kayar Yatak	6,00 \$
MFX-12038-HBPQ-5	230VAC, Rulmanlı	9,00 \$
<b>172x150x50mm Oval Fan</b>		
MFX-17250-HSPQ-5	230VAC, Kayar Yatak	15,00 \$
MFX-17250-HBPQ-5	230VAC, Rulmanlı	20,00 \$

## KÖPRÜ DİYOT



ÜRÜN KODU	AÇIKLAMA	ADET (\$)
KBPC-3510	35A / 1000V	1,50 \$
KBPC-5010	50A / 1000V	2,80 \$

## VİNÇ KUMANDA BUTONU

ÜRÜN KODU	AÇIKLAMA	ADET (\$)
<b>Tek Hızlı</b>		
MVC-61020	2 Yön	3,40 \$
MVC-61040	4 Yön	4,60 \$
MVC-61060	6 Yön	6,10 \$
MVC-61080	8 Yön	8,30 \$
<b>Tek Hızlı, Acil Stoplu</b>		
MVC-61520	2 Yön	10,50 \$
MVC-61540	4 Yön	14,50 \$
MVC-61560	6 Yön	18,50 \$
MVC-61580	8 Yön	22,50 \$
<b>Tek Hızlı, Acil Stoplu</b>		
MVC-71520	2 Yön	13,00 \$
MVC-71540	4 Yön	18,00 \$
MVC-71560	6 Yön	23,50 \$
MVC-71580	8 Yön	28,00 \$
<b>Çift Hızlı, Acil Stoplu</b>		
MVC-82520	2 Yön	25,00 \$
MVC-82540	4 Yön	37,00 \$
MVC-82560	6 Yön	50,00 \$
MVC-82580	8 Yön	62,00 \$
<b>Araç Lift Kumandası</b>		
MVC-21020	2 Yön	14,20 \$
MVC-21030	3 Yön	20,50 \$
MVC-21040	4 Yön	25,20 \$

## KUMANDA KUTULARI VE BUTON AKSESUARLARI

ÜRÜN KODU	AÇIKLAMA / KONTAK	ADET (\$)
<b>Kumanda Kutuları, 3A/250VAC, IP65 Contalı</b>		
MB3-BX150	Acil Stop Butonlu	3,00 \$
MB3-BX151	Acil Stop Butonlu Korumalı	3,20 \$
MB3-BX110	Alarm Butonu	2,70 \$
MB3-BX121	Pilli	7,50 \$
<b>Buton Aksesuarları</b>		
BR1	Buton için Etiket	0,13 \$
R60	060 mm Emergency Stop Etiket	0,35 \$
BK11	022 mm Buton Koruyucu 4 Parmak	0,50 \$
BK12	022 mm Buton Koruyucu 2 Parmak	0,50 \$



## AYAK PEDALI

ÜRÜN KODU	GÖVDE / BOYUT	ADET (\$)
<b>Tek Kademeli Pedal, 2m Kablolu (Kontak: CO, 10A/250 V AC)</b>		
MPD-15050	Plastik / 100x62x32 mm	5,80 \$
MPD-15090	Plastik / 100x62x32 mm	7,00 \$
MPD-15100	Sac / 100x70x33 mm	6,40 \$
MPD-15200	Döküm / 135x65x45 mm	7,20 \$
MPD-15300	Döküm / 165x80x55 mm	8,70 \$
<b>Korumalı Pedal, Tek Kademe (Kontak: CO)</b>		
MPD-15400	Döküm / 200x100x130 mm	21,00 \$
MPD-15600	Döküm / 210x150x125 mm	30,00 \$



**RÖLE**

ÜRÜN KODU	VOLTAJ	ADET (\$)
<b>Mini Röle, 1 Kontak - 5 Pin, 10A / 250VAC</b>		
MRL-41005	230VAC	5,00 \$
MRL-41006	12VDC	3,20 \$
MRL-41007	24VDC	3,20 \$
<b>Mini Röle, 2 Kontak - 8 Pin, 5A / 250VAC</b>		
MRL-42005	230VAC	5,50 \$
MRL-42006	12VDC	3,50 \$
MRL-42007	24VDC	3,50 \$
<b>2 Kontak - 8 Pin, Kontak: 2CO, 10A/250VAC</b>		
MRL-52001	12VAC	4,00 \$
MRL-52002	24VAC	4,00 \$
MRL-52004	110VAC	4,00 \$
MRL-52005	230VAC	4,00 \$
MRL-52006	12VDC	4,00 \$
MRL-52007	24VDC	4,00 \$
<b>4 Kontak - 14 Pin, Kontak: 4CO, 5A/250VAC</b>		
MRL-54001	12VAC	4,20 \$
MRL-54002	24VAC	4,20 \$
MRL-54004	110VAC	4,20 \$
MRL-54005	230VAC	4,20 \$
MRL-54006	12VDC	4,20 \$
MRL-54007	24VDC	4,20 \$
<b>2 Kontak - 8 Pin, Kontak: 2CO, 10A/250VAC</b>		
MRL-62001	12VAC	7,00 \$
MRL-62002	24VAC	7,00 \$
MRL-62004	110VAC	7,00 \$
MRL-62005	230VAC	7,00 \$
MRL-62006	12VDC	7,00 \$
MRL-62007	24VDC	7,00 \$
<b>3 Kontak - 11 Pin, Kontak: 3CO, 10A/250VAC</b>		
MRL-63001	12VAC	7,20 \$
MRL-63002	24VAC	7,20 \$
MRL-63004	110VAC	7,20 \$
MRL-63005	230VAC	7,20 \$
MRL-63006	12VDC	7,20 \$
MRL-63007	24VDC	7,20 \$



MSC-80 054 14 Pin 2,50 \$ MSC-80 062 8 Pin 2,30 \$  
MSC-80 063 11 Pin 2,50 \$ MSC-90 042 8 Pin 3,00 \$



MSC-90 054 14 Pin 4,50 \$ MSC-90 062 8 Pin 4,00 \$  
MSC-90 063 11 Pin 4,00 \$

**SOLID STATE RÖLE**

ÜRÜN KODU	AÇIKLAMA	ADET (\$)
<b>DC-AC 1 Kutup, Giriş: 3-32VDC Çıkış: 24-480VAC</b>		
MSR-21015	1x15A	9,00 \$
MSR-21025	1x25A	9,20 \$
MSR-21040	1x40A	10,30 \$
MSR-21050	1x50A	12,50 \$
MSR-21060	1x60A	20,00 \$
MSR-21080	1x80A	20,60 \$
MSR-21090	1x90A	32,00 \$
<b>DC-AC 3 Kutup, Giriş: 3-32VDC Çıkış: 24-530VAC</b>		
MSR-23015	3x15A	34,00 \$
MSR-23025	3x25A	34,30 \$
MSR-23040	3x40A	40,00 \$
MSR-23050	3x50A	48,40 \$
MSR-23060	3x60A	70,00 \$
MSR-23080	3x80A	70,90 \$
MSR-23090	3x90A	93,80 \$
<b>AC-AC 1 Kutup, Giriş: 80-250VDC Çıkış: 24-480VAC</b>		
MSR-51015	1x15A	11,20 \$
MSR-51025	1x25A	11,40 \$
MSR-51040	1x40A	12,60 \$
MSR-51050	1x50A	15,30 \$
MSR-51060	1x60A	24,80 \$
MSR-51080	1x80A	25,20 \$
MSR-51090	1x90A	39,70 \$
<b>AC-AC 3 Kutup, Giriş: 80-250VDC Çıkış: 24-530VAC</b>		
MSR-53015	3x15A	41,00 \$
MSR-53025	3x25A	41,20 \$
MSR-53040	3x40A	48,10 \$
MSR-53050	3x50A	58,50 \$
MSR-53060	3x60A	85,10 \$
MSR-53080	3x80A	85,80 \$
MSR-53090	3x90A	112,00 \$
<b>DC-DC 1 Kutup, Giriş: 3-32VDC Çıkış: 5-110VDC</b>		
MSR-31015	1x15A	14,70 \$
MSR-31025	1x25A	14,90 \$
MSR-31040	1x40A	17,00 \$
MSR-31050	1x50A	20,30 \$
MSR-31060	1x60A	32,20 \$
<b>Ohm-AC 1 Kutup, Giriş: 470-560kOhm Çıkış: 0-280VAC, Triac(Analog)</b>		
MSR-91015	1x15A	11,20 \$
MSR-91025	1x25A	11,40 \$
MSR-91040	1x40A	13,60 \$
MSR-91050	1x50A	16,20 \$
MSR-91060	1x60A	24,80 \$



## Ø6,5 ENDÜKTİF SENSÖR

ÜRÜN KODU	ÇIKIŞ	FONK.	VOLTAJ	ADET (\$)
<b>M6 Gövde, Algılama: 1mm, Düz Kafa</b>				
LM6-3001NA	NPN	NO	10-30VDC	18,80 \$
LM6-3001NB	NPN	NC	10-30VDC	20,00 \$
LM6-3001PA	PNP	NO	10-30VDC	18,80 \$
LM6-3001PB	PNP	NC	10-30VDC	20,00 \$
<b>M6 Endüktif Sensör, Algılama: 2mm, Çıkık Kafa</b>				
LM6-3002NA	NPN	NO	10-30VDC	18,80 \$
LM6-3002NB	NPN	NC	10-30VDC	20,00 \$
LM6-3002PA	PNP	NO	10-30VDC	18,80 \$
LM6-3002PB	PNP	NC	10-30VDC	20,00 \$

## M8 ENDÜKTİF SENSÖR

ÜRÜN KODU	ÇIKIŞ	FONK.	VOLTAJ	ADET (\$)
<b>M8 Gövde - Kablolu, Algılama: 1mm, Düz Kafa</b>				
LM8-3001NA	NPN	NO	10-30VDC	9,70 \$
LM8-3001NB	NPN	NC	10-30VDC	17,80 \$
LM8-3001PA	PNP	NO	10-30VDC	9,70 \$
LM8-3001PB	PNP	NC	10-30VDC	17,80 \$
LM8-3001LA	DC 2Tel	NO	10-30VDC	27,60 \$
LM8-2001A	AC 2Tel	NO	90-250VAC	27,60 \$
<b>M8 Gövde - Kablolu, Algılama: 2mm, Çıkık Kafa</b>				
LM8-3002NA	NPN	NO	10-30VDC	9,70 \$
LM8-3002NB	NPN	NC	10-30VDC	17,80 \$
LM8-3002PA	PNP	NO	10-30VDC	9,70 \$
LM8-3002PB	PNP	NC	10-30VDC	17,80 \$
LM8-3002LA	DC 2Tel	NO	10-30VDC	27,60 \$
LM8-2002A	AC 2Tel	NO	90-250VAC	27,60 \$
<b>M8 Gövde - Konnektörlü, Algılama: 1mm, Düz Kafa</b>				
LM8-3001NAT	NPN	NO	10-30VDC	24,80 \$
LM8-3001NBT	NPN	NC	10-30VDC	28,20 \$
LM8-3001PAT	PNP	NO	10-30VDC	24,80 \$
LM8-3001PBT	PNP	NC	10-30VDC	28,20 \$
<b>M8 Gövde - Konnektörlü, Algılama: 2mm, Çıkık Kafa</b>				
LM8-3002NAT	NPN	NO	10-30VDC	24,80 \$
LM8-3002NBT	NPN	NC	10-30VDC	28,20 \$
LM8-3002PAT	PNP	NO	10-30VDC	24,80 \$
LM8-3002PBT	PNP	NC	10-30VDC	28,20 \$
<b>M12 Konnektörlü, Algılama: 1mm, Düz Kafa</b>				
LM8-3001NAT-M12	NPN	NO	10-30VDC	24,80 \$
LM8-3001NBT-M12	NPN	NC	10-30VDC	28,20 \$
LM8-3001PAT-M12	PNP	NO	10-30VDC	24,80 \$
LM8-3001PBT-M12	PNP	NC	10-30VDC	28,20 \$
<b>M12 Konnektörlü, Algılama: 2mm, Çıkık Kafa</b>				
LM8-3002NAT-M12	NPN	NO	10-30VDC	24,80 \$
LM8-3002NBT-M12	NPN	NC	10-30VDC	28,20 \$
LM8-3002PAT-M12	PNP	NO	10-30VDC	24,80 \$
LM8-3002PBT-M12	PNP	NC	10-30VDC	28,20 \$

## M12 ENDÜKTİF SENSÖR

ÜRÜN KODU	ÇIKIŞ	FONK.	VOLTAJ	ADET (\$)
<b>M12 Gövde - Kablolu, Algılama: 2mm, Düz Kafa</b>				
LM12-3002NA	NPN	NO	10-30VDC	7,70 \$
LM12-3002NC	NPN	NO+NC	10-30VDC	15,30 \$
LM12-3002PA	PNP	NO	10-30VDC	7,70 \$
LM12-3002PC	PNP	NO+NC	10-30VDC	15,30 \$
LM12-3002LA	DC 2Tel	NO	10-30VDC	19,80 \$
LM12-3002LB	DC 2Tel	NC	10-30VDC	19,80 \$
LM12-2002A	AC 2Tel	NO	90-250VAC	19,80 \$
<b>M12 Gövde - Kablolu, Algılama: 4 mm, Çıkık Kafa</b>				
LM12-3004NA	NPN	NO	10-30VDC	7,70 \$
LM12-3004NC	NPN	NO+NC	10-30VDC	15,30 \$
LM12-3004PA	PNP	NO	10-30VDC	7,70 \$
LM12-3004PC	PNP	NO+NC	10-30VDC	15,30 \$
LM12-3004LA	DC 2Tel	NO	10-30VDC	19,80 \$
LM12-3004LB	DC 2Tel	NC	10-30VDC	19,80 \$
LM12-2004A	AC 2Tel	NO	90-250VAC	19,80 \$
<b>M12 Gövde - M12 Konnektörlü, Algılama: 2 mm, Düz Kafa</b>				
LM12-3002NAT	NPN	NO	10-30VDC	9,70 \$
LM12-3002NCT	NPN	NO+NC	10-30VDC	17,50 \$
LM12-3002PAT	PNP	NO	10-30VDC	9,70 \$
LM12-3002PCT	PNP	NO+NC	10-30VDC	17,50 \$
<b>M12 Gövde - M12 Konnektörlü, Algılama: 4 mm, Çıkık Kafa</b>				
LM12-3004NAT	NPN	NO	10-30VDC	9,70 \$
LM12-3004NCT	NPN	NO+NC	10-30VDC	17,50 \$
LM12-3004PAT	PNP	NO	10-30VDC	9,70 \$
LM12-3004PCT	PNP	NO+NC	10-30VDC	17,50 \$

## PTET SERİSİ PRİZMATİK FOTOSELLER



### Genel Özellikler:

50x50x17mm ebat NA/NK seçilebilir çıkış  
Çalışma gerilimi: 10-30VDC



### Genel Özellikler:

50x50x17mm ebat NA/NK seçilebilir çıkış  
Çalışma gerilimi: 24-240VAC/12-240VDC

### DC MODELLER

ÜRÜN KODU	BAĞLANTI	ALGILAMA MESAFESİ	İŞİMA TİPİ	ÇIKIŞ	ADET (\$)
<b>CİSİMDEN YANSIMALI</b>					
PTET-BC200DFB	2m KABLO	200 cm	PRİZMATİK	PNP-NPN NO+NC	62,00 \$
PTET-BC200DFB-E2	M12 KONNEKTÖR	200 cm	PRİZMATİK	PNP-NPN NO+NC	64,00 \$
<b>REFLEKTÖRLÜ</b>					
PTET-BC250DFB	2m KABLO	250 cm	PRİZMATİK	PNP-NPN NO+NC	62,00 \$
PTET-BC250DFB-E2	M12 KONNEKTÖR	250 cm	PRİZMATİK	PNP-NPN NO+NC	64,00 \$
<b>KARŞILIKLI</b>					
PTET-PM5DFB	2m KABLO	5 mt	PRİZMATİK	PNP-NPN NO+NC	64,00 \$
PTET-PM5DFB-E2	M12 KONNEKTÖR	5 mt	PRİZMATİK	PNP-NPN NO+NC	66,00 \$
<b>KARŞILIKLI</b>					
PTET-PM8DFB	2m KABLO	8 mt	PRİZMATİK	PNP-NPN NO+NC	66,00 \$
PTET-PM8DFB-E2	M12 KONNEKTÖR	8 mt	PRİZMATİK	PNP-NPN NO+NC	68,00 \$
<b>KARŞILIKLI</b>					
PTET-TM60DFB	2m KABLO	60 mt	PRİZMATİK	PNP-NPN NO+NC	40,00 \$
PTET-TM60D	2m KABLO	60 mt	PRİZMATİK	İŞİK KAYNAĞI	28,00 \$
PTET-TM60DFB-E2	M12 KONNEKTÖR	60 mt	PRİZMATİK	PNP-NPN NO+NC	42,00 \$
PTET-TM60D-E2	M12 KONNEKTÖR	60 mt	PRİZMATİK	İŞİK KAYNAĞI	30,00 \$

### AC/DC MODELLER

ÜRÜN KODU	BAĞLANTI	ALGILAMA MESAFESİ	İŞİMA TİPİ	ÇIKIŞ	ADET (\$)
<b>CİSİMDEN YANSIMALI</b>					
PTET-BC200SK	2m KABLO	200 cm	PRİZMATİK	AC/DC 5 KABLULU	63,00 \$
PTET-BC250SK	2m KABLO	250 cm	PRİZMATİK	AC/DC 5 KABLULU	65,00 \$
<b>REFLEKTÖRLÜ</b>					
PTET-PM5SK	2m KABLO	5 mt	PRİZMATİK	AC/DC 5 KABLULU	64,00 \$
PTET-PM8SK	2m KABLO	8 mt	PRİZMATİK	AC/DC 5 KABLULU	67,00 \$
<b>KARŞILIKLI</b>					
PTET-TM60SK	2m KABLO	60 mt	PRİZMATİK	AC/DC 5 KABLULU	46,00 \$
PTET-TM60S	2m KABLO	60 mt	PRİZMATİK	İŞİK KAYNAĞI	32,00 \$

## PTFT SERİSİ PRİZMATİK FOTOSELLER



### Genel Özellikler:

50x50x17mm ebat NA/NK seçilebilir çıkış  
Çalışma gerilimi: 10-30VDC



### Genel Özellikler:

50x50x17mm ebat NA/NK seçilebilir çıkış  
Çalışma gerilimi: 24-240VAC/12-240VDC

### DC MODELLER

ÜRÜN KODU	BAĞLANTI	ALGILAMA MESAFESİ	İŞİMA TİPİ	ÇIKIŞ	ADET (\$)
<b>CİSİMDEN YANSIMALI</b>					
PTFT-BC100DPR	2m KABLO	100 cm	PRİZMATİK	PNP NO+NC	52,00 \$
PTFT-BC100DNR	2m KABLO	100 cm	PRİZMATİK	NPN NO+NC	52,00 \$
PTFT-BC100DPR-E2	M12 KONNEKTÖR	100 cm	PRİZMATİK	PNP NO+NC	55,00 \$
PTFT-BC100DNR-E2	M12 KONNEKTÖR	100 cm	PRİZMATİK	NPN NO+NC	55,00 \$
<b>KARŞILIKLI</b>					
PTFT-TM20DPR	2m KABLO	20 mt	PRİZMATİK	PNP NO+NC	39,00 \$
PTFT-TM20DNR	2m KABLO	20 mt	PRİZMATİK	NPN NO+NC	39,00 \$
PTFT-TM20D	2m KABLO	20 mt	PRİZMATİK	İŞİK KAYNAĞI	30,00 \$
PTFT-TM20DPR-E2	M12 KONNEKTÖR	20 mt	PRİZMATİK	PNP NO+NC	41,00 \$
PTFT-TM20DNR-E2	M12 KONNEKTÖR	20 mt	PRİZMATİK	NPN NO+NC	41,00 \$
PTFT-TM20D-E2	M12 KONNEKTÖR	20 mt	PRİZMATİK	İŞİK KAYNAĞI	32,00 \$

### AC/DC MODELLER

ÜRÜN KODU	BAĞLANTI	ALGILAMA MESAFESİ	İŞİMA TİPİ	ÇIKIŞ	ADET (\$)
<b>KARŞILIKLI</b>					
PTFT-TM20SK	2m KABLO	20 mt	PRİZMATİK	AC/DC 5 KABLULU	45,00 \$
PTFT-TM20S	2m KABLO	20 mt	PRİZMATİK	İŞİK KAYNAĞI	31,00 \$

## PSET SERİSİ PRİZMATİK FOTOSELLER / TOUCH BUTTON



**Genel Özellikler:**  
32x21x12,3mm ebat  
Çalışma gerilimi: 12-24VDC

DC MODELLER

ÜRÜN KODU	BAĞLANTI	ALGILAMA MESAFESİ	İŞİM TİPİ	ÇIKIŞ	ADET (\$)
<b>CİSİMDEN YANSIMALI</b>					
PSET-BC30DPBR	2m KABLO	30 cm	RED LIGHT	PNP NO+NC	49,00 \$
PSET-BC30DNBR	2m KABLO	30 cm	RED LIGHT	NPN NO+NC	49,00 \$
PSET-BC30DPBR-E3	M8 KONNEKTÖR	30 cm	RED LIGHT	PNP NO+NC	52,00 \$
PSET-BC30DNBR-E3	M8 KONNEKTÖR	30 cm	RED LIGHT	NPN NO+NC	52,00 \$
PSET-BC100DPB	2m KABLO	100 cm	INFRARED	PNP NO+NC	50,00 \$
PSET-BC100DNB	2m KABLO	100 cm	INFRARED	NPN NO+NC	50,00 \$
PSET-BC100DPB-E3	M8 KONNEKTÖR	100 cm	INFRARED	PNP NO+NC	53,00 \$
PSET-BC100DNB-E3	M8 KONNEKTÖR	100 cm	INFRARED	NPN NO+NC	53,00 \$
<b>POLARİZE REFLEKTÖRLÜ</b>					
PSET-PM3DPBR	2m KABLO	2 mt	RED LIGHT	PNP NO+NC	51,00 \$
PSET-PM3DNBR	2m KABLO	2 mt	RED LIGHT	NPN NO+NC	51,00 \$
PSET-PM3DPBR-E3	M8 KONNEKTÖR	2 mt	RED LIGHT	PNP NO+NC	54,00 \$
PSET-PM3DNBR-E3	M8 KONNEKTÖR	2 mt	RED LIGHT	NPN NO+NC	54,00 \$
<b>KARŞILIKLI</b>					
PSET-TM20DPB	2m KABLO	20 mt	INFRARED	PNP NO+NC	35,00 \$
PSET-TM20DNB	2m KABLO	20 mt	INFRARED	NPN NO+NC	35,00 \$
PSET-TM20D	2m KABLO	20 mt	INFRARED	İŞİK KAYNAĞI	25,00 \$
PSET-TM20DPB-E3	M8 KONNEKTÖR	20 mt	INFRARED	PNP NO+NC	38,00 \$
PSET-TM20DNB-E3	M8 KONNEKTÖR	20 mt	INFRARED	NPN NO+NC	38,00 \$
PSET-TM20D-E3	M18KONNEKTÖR	20 mt	INFRARED	İŞİK KAYNAĞI	26,00 \$

## PSEPT SERİSİ KÜBİK TİP FOTOSELLER / POTANS MESAFE AYARLI



**Genel Özellikler:**  
32x21x12,3mm ebat  
Çalışma gerilimi: 12-24VDC

DC MODELLER

ÜRÜN KODU	BAĞLANTI	ALGILAMA MESAFESİ	İŞİM TİPİ	ÇIKIŞ	ADET (\$)
<b>CİSİMDEN YANSIMALI</b>					
PSEPT-BC30DPBR	2m KABLO	30 cm	RED LIGHT	PNP NO+NC	49,00 \$
PSEPT-BC30DNBR	2m KABLO	30 cm	RED LIGHT	NPN NO+NC	49,00 \$
PSEPT-BC30DPBR-E3	M8 KONNEKTÖR	30 cm	RED LIGHT	PNP NO+NC	52,00 \$
PSEPT-BC30DNBR-E3	M8 KONNEKTÖR	30 cm	RED LIGHT	NPN NO+NC	52,00 \$

## PSET SERİSİ TRANSPARAN REFLEKTÖRLÜ / TOUCH BUTTON



**Genel Özellikler:**  
32x21x12,3mm ebat  
Çalışma gerilimi: 12-24VDC

DC MODELLER

ÜRÜN KODU	BAĞLANTI	ALGILAMA MESAFESİ	İŞİM TİPİ	ÇIKIŞ	ADET (\$)
<b>CİSİMDEN YANSIMALI</b>					
PSET-GM2DPBB	2m KABLO	30 cm	RED LIGHT	PNP NO+NC	90,00 \$
PSET-GM2DNBB	2m KABLO	30 cm	RED LIGHT	NPN NO+NC	90,00 \$
PSET-GM2DPBB-E3	M8 KONNEKTÖR	30 cm	RED LIGHT	PNP NO+NC	93,00 \$
PSET-GM2DNBB-E3	M8 KONNEKTÖR	30 cm	RED LIGHT	NPN NO+NC	93,00 \$

## PR18T SERİSİ PASLANMAZ METAL FOTOSELLER



### Genel Özellikler:

Metal gövde M18X1mm  
Çalışma gerilimi : 10-30VDC  
I<sub>max</sub> : 200mA Tepki süresi 3ms  
Çalışma sıcaklığı : -15...+55°C  
IP67 koruma sınıfı mesafe ayarlı

### DC MODELLER

ÜRÜN KODU	BAĞLANTI	ALGILAMA MESAFESİ	ÇAP	ÇIKIŞ	ADET (\$)
<b>CİSİMDEN YANSIMALI</b>					
PR18T-BC10DPR	2m KABLO	10 cm	M18	PNP NO+NC	39,00 \$
PR18T-BC10DNR	2m KABLO	10 cm	M18	NPN NO+NC	39,00 \$
PR18T-BC10DPR-E2	M12 KONNEKTÖR	10 cm	M18	PNP NO+NC	45,00 \$
PR18T-BC10DNR-E2	M12 KONNEKTÖR	10 cm	M18	NPN NO+NC	45,00 \$
PR18T-BC40DPR	2m KABLO	40 cm	M18	PNP NO+NC	39,00 \$
PR18T-BC40DNR	2m KABLO	40 cm	M18	NPN NO+NC	39,00 \$
PR18T-BC40DPR-E2	M12 KONNEKTÖR	40 cm	M18	PNP NO+NC	46,00 \$
PR18T-BC40DNR-E2	M12 KONNEKTÖR	40 cm	M18	NPN NO+NC	46,00 \$
<b>REFLEKTÖRLÜ</b>					
PR18T-DM3DPR	2m KABLO	3 mt	M18	PNP NO+NC	41,00 \$
PR18T-DM3DNR	M12 KONNEKTÖR	3 mt	M18	NPN NO+NC	41,00 \$
PR18T-DM3DPR-E2	2m KABLO	3 mt	M18	PNP NO+NC	46,00 \$
PR18T-DM3DNR-E2	M12 KONNEKTÖR	3 mt	M18	NPN NO+NC	46,00 \$
<b>KARŞILIKLI</b>					
PR18T-TM20DPR	2m KABLO	20 mt	M18	PNP NO+NC	41,00 \$
PR18T-TM20DNR	2m KABLO	20 mt	M18	NPN NO+NC	41,00 \$
PR18T-TM20DPR-E2	M12 KONNEKTÖR	20 mt	M18	PNP NO+NC	45,00 \$
PR18T-TM20DNR-E2	M12 KONNEKTÖR	20 mt	M18	NPN NO+NC	45,00 \$
PR18T-TM20D	2m KABLO	20 mt	M18	İŞIK KAYNAĞI	28,00 \$
PR18T-TM20D-E2	M12 KONNEKTÖR	20 mt	M18	İŞIK KAYNAĞI	30,00 \$

## PR18TS SERİSİ PLASTİK GÖVDE FOTOSELLER



### Genel Özellikler:

Plastik gövde M18X1mm  
Çalışma gerilimi : 10-30VDC  
I<sub>max</sub> : 200mA Tepki süresi 3ms  
Çalışma sıcaklığı : -15...+55°C  
IP67 koruma sınıfı mesafe ayarlı

### DC MODELLER

ÜRÜN KODU	BAĞLANTI	ALGILAMA MESAFESİ	ÇAP	ÇIKIŞ	ADET (\$)
<b>CİSİMDEN YANSIMALI</b>					
PR18TS-BC10DPR	2m KABLO	10 cm	M18	PNP NO+NC	36,00 \$
PR18TS-BC10DNR	2m KABLO	10 cm	M18	NPN NO+NC	36,00 \$
PR18TS-BC10DPR-E2	M12 KONNEKTÖR	10 cm	M18	PNP NO+NC	41,00 \$
PR18TS-BC10DNR-E2	M12 KONNEKTÖR	10 cm	M18	NPN NO+NC	41,00 \$
PR18TS-BC40DPR	2m KABLO	40 cm	M18	PNP NO+NC	36,00 \$
PR18TS-BC40DNR	2m KABLO	40 cm	M18	NPN NO+NC	36,00 \$
PR18TS-BC40DPR-E2	M12 KONNEKTÖR	40 cm	M18	PNP NO+NC	39,00 \$
PR18TS-BC40DNR-E2	M12 KONNEKTÖR	40 cm	M18	NPN NO+NC	41,00 \$
<b>REFLEKTÖRLÜ</b>					
PR18TS-DM3DPR	2m KABLO	3 mt	M18	PNP NO+NC	40,00 \$
PR18TS-DM3DNR	M12 KONNEKTÖR	3 mt	M18	NPN NO+NC	40,00 \$
PR18TS-DM3DPR-E2	2m KABLO	3 mt	M18	PNP NO+NC	41,00 \$
PR18TS-DM3DNR-E2	M12 KONNEKTÖR	3 mt	M18	NPN NO+NC	41,00 \$
<b>KARŞILIKLI</b>					
PR18TS-TM20DPR	2m KABLO	20 mt	M18	PNP NO+NC	35,00 \$
PR18TS-TM20DNR	2m KABLO	20 mt	M18	NPN NO+NC	35,00 \$
PR18TS-TM20DPR-E2	M12 KONNEKTÖR	20 mt	M18	PNP NO+NC	37,00 \$
PR18TS-TM20DNR-E2	M12 KONNEKTÖR	20 mt	M18	NPN NO+NC	37,00 \$
PR18TS-TM20D	2m KABLO	20 mt	M18	İŞIK KAYNAĞI	25,00 \$
PR18TS-TM20D-E2	M12 KONNEKTÖR	20 mt	M18	İŞIK KAYNAĞI	27,00 \$

## PR18TY SERİSİ M18 METAL GÖVDE ARKA PLAN BASTIRMALI FOTOSELLER



### Genel Özellikler:

Metal gövde M18X1mm  
Çalışma gerilimi : 10-30VDC  
I<sub>max</sub> : 200mA Tepki süresi 3ms  
Çalışma sıcaklığı : -15...+55°C  
IP67 koruma sınıfı mesafe ayarlı

### DC MODELLER

ÜRÜN KODU	BAĞLANTI	ALGILAMA MESAFESİ	ÇAP	ÇIKIŞ	ADET (\$)
<b>ARKA PLAN BASTIRMALI</b>					
PR18T-YC10DPR	2m KABLO	10 cm	M18	PNP NO+NC	110,00 \$
PR18T-YC10DNR	2m KABLO	10 cm	M18	NPN NO+NC	110,00 \$
PR18T-YC10DPR-E2	M12 KONNEKTÖR	10 cm	M18	PNP NO+NC	115,00 \$
PR18T-YC10DNR-E2	M12 KONNEKTÖR	10 cm	M18	NPN NO+NC	115,00 \$

## M8 DC 3 KABLOLU ENDÜKTİF SENSÖRLER



M8 DC ÜÇ KABLOLU

ÜRÜN KODU	ÖLÇÜ	BAĞLANTI	KAFA TİPİ	ALGILAMA MESAFESİ	ÇIKIŞ	KONTAK	FREKANS	ADET (\$)
<b>STANDART SERİ</b>								
LR08TBF15DPC	M8X1	2m KABLO	DÜZ	1,5mm	PNP	NC	2kHz	17,00 \$
LR08TBF15DNO	M8X1	2m KABLO	DÜZ	1,5mm	NPN	NO	2kHz	17,00 \$
LR08TBF15DNC	M8X1	2m KABLO	DÜZ	1,5mm	NPN	NC	2kHz	17,00 \$
LR08TBN02DPO	M8X1	2m KABLO	ÇIKIK	2mm	PNP	NO	1,5kHz	17,00 \$
LR08TBN02DPC	M8X1	2m KABLO	ÇIKIK	2mm	PNP	NC	1,5kHz	17,00 \$
LR08TBN02DNO	M8X1	2m KABLO	ÇIKIK	2mm	NPN	NO	1,5kHz	17,00 \$
LR08TBN02DNC	M8X1	2m KABLO	ÇIKIK	2mm	NPN	NC	1,5kHz	17,00 \$
LR08TBF15DPO-E1	M8X1	M8 KONNEKTÖR	DÜZ	1,5mm	PNP	NO	2kHz	24,00 \$
LR08TBF15DPC-E1	M8X1	M8 KONNEKTÖR	DÜZ	1,5mm	PNP	NC	2kHz	24,00 \$
LR08TBF15DNO-E1	M8X1	M8 KONNEKTÖR	DÜZ	1,5mm	NPN	NO	2kHz	24,00 \$
LR08TBF15DNC-E1	M8X1	M8 KONNEKTÖR	DÜZ	1,5mm	NPN	NC	2kHz	24,00 \$
LR08TBN02DPO-E1	M8X1	M8 KONNEKTÖR	ÇIKIK	2mm	PNP	NO	1,5kHz	24,00 \$
LR08TBN02DPC-E1	M8X1	M8 KONNEKTÖR	ÇIKIK	2mm	PNP	NC	1,5kHz	24,00 \$
LR08TBN02DNO-E1	M8X1	M8 KONNEKTÖR	ÇIKIK	2mm	NPN	NO	1,5kHz	24,00 \$
LR08TBN02DNC-E1	M8X1	M8 KONNEKTÖR	ÇIKIK	2mm	NPN	NC	1,5kHz	24,00 \$
LR08TBF15DPO-E2	M8X1	M12 KONNEKTÖR	DÜZ	1,5mm	PNP	NO	2kHz	20,00 \$
LR08TBF15DPC-E2	M8X1	M12 KONNEKTÖR	DÜZ	1,5mm	PNP	NC	2kHz	20,00 \$
LR08TBF15DNO-E2	M8X1	M12 KONNEKTÖR	DÜZ	1,5mm	NPN	NO	2kHz	20,00 \$
LR08TBF15DNC-E2	M8X1	M12 KONNEKTÖR	DÜZ	1,5mm	NPN	NC	2kHz	20,00 \$
<b>ARTTIRILMIŞ ALGILAMA</b>								
LR08TBF02DPOY	M8X1	2m KABLO	DÜZ	2mm	PNP	NO	1,5kHz	23,00 \$
LR08TBF02DNOY	M8X1	2m KABLO	DÜZ	2mm	NPN	NO	1,5kHz	23,00 \$
LR08TBN04DPOY	M8X1	2m KABLO	ÇIKIK	4mm	PNP	NO	1,5kHz	23,00 \$
LR08TBN04DNOY	M8X1	2m KABLO	ÇIKIK	4mm	NPN	NO	1,5kHz	23,00 \$
LR08TBF02DPOY-E1	M8X1	M8 KONNEKTÖR	DÜZ	2mm	PNP	NO	1,5kHz	26,00 \$
LR08TBF02DNOY-E1	M8X1	M8 KONNEKTÖR	DÜZ	2mm	NPN	NO	1,5kHz	26,00 \$
LR08TBN04DPOY-E1	M8X1	M8 KONNEKTÖR	ÇIKIK	4mm	PNP	NO	1,5kHz	30,00 \$
LR08TBN04DNOY-E1	M8X1	M8 KONNEKTÖR	ÇIKIK	4mm	NPN	NO	1,5kHz	30,00 \$
LR08TBF02DPOY-E2	M8X1	M12 KONNEKTÖR	DÜZ	2mm	PNP	NO	1,5kHz	30,00 \$
LR08TBF02DNOY-E2	M8X1	M12 KONNEKTÖR	DÜZ	2mm	NPN	NO	1,5kHz	30,00 \$
LR08TBN04DPOY-E2	M8X1	M12 KONNEKTÖR	ÇIKIK	4mm	PNP	NO	1,5kHz	30,00 \$
LR08TBN04DNOY-E2	M8X1	M12 KONNEKTÖR	ÇIKIK	4mm	NPN	NO	1,5kHz	30,00 \$
<b>KISA SERİ</b>								
LR08TAF15DPO	M8X1**	2m KABLO	DÜZ	1,5mm	PNP	NO	2kHz	21,00 \$
LR08TAF15DPC	M8X1**	2m KABLO	DÜZ	1,5mm	PNP	NC	2kHz	21,00 \$
LR08TAF15DNO	M8X1**	2m KABLO	DÜZ	1,5mm	NPN	NO	2kHz	21,00 \$
LR08TAF15DNC	M8X1**	2m KABLO	DÜZ	1,5mm	NPN	NC	2kHz	21,00 \$
LR08TAN02DPO	M8X1**	2m KABLO	ÇIKIK	2mm	PNP	NO	1,5kHz	21,00 \$
LR08TAN02DNO	M8X1**	2m KABLO	ÇIKIK	2mm	NPN	NO	1,5kHz	21,00 \$
LR08TAF15DPO-E1	M8X1**	M8 KONNEKTÖR	DÜZ	1,5mm	PNP	NO	2kHz	26,00 \$
LR08TAF15DPC-E1	M8X1**	M8 KONNEKTÖR	DÜZ	1,5mm	PNP	NC	2kHz	26,00 \$
LR08TAF15DNO-E1	M8X1**	M8 KONNEKTÖR	DÜZ	1,5mm	NPN	NO	2kHz	26,00 \$
LR08TAF15DNC-E1	M8X1**	M8 KONNEKTÖR	DÜZ	1,5mm	NPN	NC	2kHz	26,00 \$
LR08TAF15DPO-E2	M8X1**	M12 KONNEKTÖR	DÜZ	1,5mm	PNP	NO	2kHz	26,00 \$
LR08TAF15DPC-E2	M8X1**	M12 KONNEKTÖR	DÜZ	1,5mm	PNP	NC	2kHz	26,00 \$
LR08TAF15DNO-E2	M8X1**	M12 KONNEKTÖR	DÜZ	1,5mm	NPN	NO	2kHz	26,00 \$
LR08TAF15DNC-E2	M8X1**	M12 KONNEKTÖR	DÜZ	1,5mm	NPN	NC	2kHz	26,00 \$

### Genel Özellikler:

Çalışma gerilimi : 10-30VDC  
 Çalışma sıcaklığı : -25...+70°C  
 IP 67 Koruma sınıfı  
 Kısa devre ve faz dalgalanmalarına karşı korumalı

\*\* Modeller kısa gövdedir



## M12 DC 3 KABLOLU ENDÜKTİF SENSÖRLER



M12 DC 3 KABLOLU

ÜRÜN KODU	ÖLÇÜ	BAĞLANTI	KAFA TİPİ	ALGILAMA MESAFESİ	ÇIKIŞ	KONTAK	FREKANS	ADET (\$)
<b>STANDART SERİ</b>								
LR12TBF04DPOY	M12X1	2m KABLO	DÜZ	4mm	PNP	NO	800Hz	13,00 \$
LR12TBF04DPCY	M12X1	2m KABLO	DÜZ	4mm	PNP	NC	800Hz	14,00 \$
LR12TBF04DNOY	M12X1	2m KABLO	DÜZ	4mm	NPN	NO	800Hz	13,00 \$
LR12TBF04DNKY	M12X1	2m KABLO	DÜZ	4mm	NPN	NC	800Hz	14,00 \$
LR12TBF04DPRY	M12X1	2m KABLO	DÜZ	4mm	PNP	NO + NC	800Hz	25,00 \$
LR12TBF04DNRY	M12X1	2m KABLO	DÜZ	4mm	NPN	NO + NC	800Hz	25,00 \$
LR12TBF04DPOY-E2	M12X1	M12 KONNEKTÖR	DÜZ	4mm	PNP	NO	800Hz	13,00 \$
LR12TBF04DPCY-E2	M12X1	M12 KONNEKTÖR	DÜZ	4mm	PNP	NC	800Hz	14,00 \$
LR12TBF04DNOY-E2	M12X1	M12 KONNEKTÖR	DÜZ	4mm	NPN	NO	800Hz	13,00 \$
LR12TBF04DNKY-E2	M12X1	M12 KONNEKTÖR	DÜZ	4mm	NPN	NC	800Hz	14,00 \$
LR12TBF04DPRY-E2	M12X1	M12 KONNEKTÖR	DÜZ	4mm	PNP	NO + NC	800Hz	28,00 \$
LR12TBF04DNRY-E2	M12X1	M12 KONNEKTÖR	DÜZ	4mm	NPN	NO + NC	800Hz	28,00 \$
LR12TBN08DPOY	M12X1	2m KABLO	ÇIKIK	8mm	PNP	NO	500Hz	18,00 \$
LR12TBN08DPCY	M12X1	2m KABLO	ÇIKIK	8mm	PNP	NC	500Hz	18,00 \$
LR12TBN08DNOY	M12X1	2m KABLO	ÇIKIK	8mm	NPN	NO	500Hz	18,00 \$
LR12TBN08DNKY	M12X1	2m KABLO	ÇIKIK	8mm	NPN	NC	500Hz	18,00 \$
LR12TBN08DPRY	M12X1	2m KABLO	ÇIKIK	8mm	PNP	NO + NC	500Hz	32,00 \$
LR12TBN08DNRY	M12X1	2m KABLO	ÇIKIK	8mm	NPN	NO + NC	500Hz	32,00 \$
LR12TBN08DPOY-E2	M12X1	M12 KONNEKTÖR	ÇIKIK	8mm	PNP	NO	500Hz	20,00 \$
LR12TBN08DPCY-E2	M12X1	M12 KONNEKTÖR	ÇIKIK	8mm	PNP	NC	500Hz	20,00 \$
LR12TBN08DNOY-E2	M12X1	M12 KONNEKTÖR	ÇIKIK	8mm	NPN	NO	500Hz	20,00 \$
LR12TBN08DNKY-E2	M12X1	M12 KONNEKTÖR	ÇIKIK	8mm	NPN	NC	500Hz	20,00 \$
LR12TBN08DPRY-E2	M12X1	M12 KONNEKTÖR	ÇIKIK	8mm	PNP	NO + NC	500Hz	35,00 \$
LR12TBN08DNRY-E2	M12X1	M12 KONNEKTÖR	ÇIKIK	8mm	NPN	NO + NC	500Hz	35,00 \$
<b>KISA SERİ</b>								
LR12TAF04DPOY	M12X1**	2m KABLO	DÜZ	4mm	PNP	NO	800Hz	15,00 \$
LR12TAF04DNOY	M12X1**	2m KABLO	DÜZ	4mm	NPN	NO	800Hz	15,00 \$
LR12TAF04DPCY	M12X1**	2m KABLO	DÜZ	4mm	PNP	NC	800Hz	16,00 \$
LR12TAF04DNKY	M12X1**	2m KABLO	DÜZ	4mm	NPN	NC	800Hz	16,00 \$
LR12TAF04DPOY-E2	M12X1**	M12 KONNEKTÖR	DÜZ	4mm	PNP	NO	800Hz	17,00 \$
LR12TAF04DPCY-E2	M12X1**	M12 KONNEKTÖR	DÜZ	4mm	PNP	NC	800Hz	17,00 \$
LR12TAF04DNOY-E2	M12X1**	M12 KONNEKTÖR	DÜZ	4mm	NPN	NO	800Hz	17,00 \$
LR12TAF04DNKY-E2	M12X1**	M12 KONNEKTÖR	DÜZ	4mm	NPN	NC	800Hz	17,00 \$
<b>UZUN SERİ ARTIRILMIŞ ALGILAMA</b>								
LR12TCF06DPOY	M12X1	2m KABLO	DÜZ	6mm	PNP	NO	500Hz	38,00 \$
LR12TCF06DNOY	M12X1	2m KABLO	DÜZ	6mm	NPN	NO	500Hz	38,00 \$
LR12TCF06DPOY-E2	M12X1	M12 KONNEKTÖR	DÜZ	6mm	PNP	NO	500Hz	40,00 \$
LR12TCF06DNOY-E2	M12X1	M12 KONNEKTÖR	DÜZ	6mm	NPN	NO	500Hz	40,00 \$
LR12TCN10DPOY	M12X1	2m KABLO	ÇIKIK	10mm	PNP	NO	500Hz	40,00 \$
LR12TCN10DPOY-E2	M12X1	M12 KONNEKTÖR	ÇIKIK	10mm	PNP	NO	500Hz	40,00 \$
LR12TCN10DNOY	M12X1	2m KABLO	ÇIKIK	10mm	NPN	NO	500Hz	40,00 \$
LR12TCN10DNOY-E2	M12X1	M12 KONNEKTÖR	ÇIKIK	10mm	NPN	NO	500Hz	40,00 \$

### Genel Özellikler:

Çalışma gerilimi : 10-30VDC

Çalışma sıcaklığı : -25..+70°C

IP 67 Koruma sınıfı

Kısa devre ve faz dalganmalarına karşı korumalı

\*\* Modeller kısa gövdedir

## M18 DC 3/4 KABLOLU ENDÜKTİF SENSÖRLER



M18 DC 3/4 KABLOLU

ÜRÜN KODU	ÖLÇÜ	BAĞLANTI	KAFA TİPİ	ALGILAMA MESAFESİ	ÇIKIŞ	KONTAK	FREKANS	ADET (\$)
<b>STANDART SERİ</b>								
LR18TBF05DPO	M18X1	2m KABLO	DÜZ	5mm	PNP	NO	1kHz	18,00 \$
LR18TBF05DPC	M18X1	2m KABLO	DÜZ	5mm	PNP	NC	1kHz	18,00 \$
LR18TBF05DNO	M18X1	2m KABLO	DÜZ	5mm	NPN	NO	1kHz	18,00 \$
LR18TBF05DNC	M18X1	2m KABLO	DÜZ	5mm	NPN	NC	1kHz	18,00 \$
LR18TBF05DPR	M18X1	2m KABLO	DÜZ	5mm	PNP	NO + NC	1kHz	26,00 \$
LR18TBF05DNR	M18X1	2m KABLO	DÜZ	5mm	NPN	NO + NC	1kHz	26,00 \$
LR18TBF05DPO-E2	M18X1	M12 KONNEKTÖR	DÜZ	5mm	PNP	NO	1kHz	26,00 \$
LR18TBF05DPC-E2	M18X1	M12 KONNEKTÖR	DÜZ	5mm	PNP	NC	1kHz	26,00 \$
LR18TBF05DNO-E2	M18X1	M12 KONNEKTÖR	DÜZ	5mm	NPN	NO	1kHz	26,00 \$
LR18TBF05DNC-E2	M18X1	M12 KONNEKTÖR	DÜZ	5mm	NPN	NC	1kHz	26,00 \$
LR18TBF05DPR-E2	M18X1	M12 KONNEKTÖR	DÜZ	5mm	PNP	NO + NC	1kHz	28,00 \$
LR18TBF05DNR-E2	M18X1	M12 KONNEKTÖR	DÜZ	5mm	NPN	NO + NC	1kHz	28,00 \$
LR18TBN08DPO	M18X1	2m KABLO	ÇIKIK	8mm	PNP	NO	800Hz	18,00 \$
LR18TBN08DPC	M18X1	2m KABLO	ÇIKIK	8mm	PNP	NC	800Hz	18,00 \$
LR18TBN08DNO	M18X1	2m KABLO	ÇIKIK	8mm	NPN	NO	800Hz	18,00 \$
LR18TBN08DNC	M18X1	2m KABLO	ÇIKIK	8mm	NPN	NC	800Hz	18,00 \$
LR18TBN08DPO-E2	M18X1	M12 KONNEKTÖR	ÇIKIK	8mm	PNP	NO	800Hz	26,00 \$
LR18TBN08DPC-E2	M18X1	M12 KONNEKTÖR	ÇIKIK	8mm	PNP	NC	800Hz	26,00 \$
LR18TBN08DNO-E2	M18X1	M12 KONNEKTÖR	ÇIKIK	8mm	NPN	NO	800Hz	26,00 \$
LR18TBN08DNC-E2	M18X1	M12 KONNEKTÖR	ÇIKIK	8mm	NPN	NC	800Hz	26,00 \$
<b>ARTTIRILMIŞ ALGILAMA</b>								
LR18TBF08DPOY	M18X1	2m KABLO	DÜZ	2mm	PNP	NO	400Hz	28,00 \$
LR18TBF08DNOY	M18X1	2m KABLO	DÜZ	2mm	NPN	NO	400Hz	28,00 \$
LR18TBF08DPCY	M18X1	2m KABLO	DÜZ	4mm	PNP	NC	400Hz	28,00 \$
LR18TBF08DNCY	M18X1	2m KABLO	DÜZ	4mm	NPN	NC	400Hz	28,00 \$
LR18TBF08DPRY	M18X1	2m KABLO	DÜZ	2mm	PNP	NO + NC	400Hz	36,00 \$
LR18TBF08DNRy	M18X1	2m KABLO	DÜZ	2mm	NPN	NO + NC	400Hz	36,00 \$
LR18TBF08DPOY-E2	M18X1	M12 KONNEKTÖR	DÜZ	4mm	PNP	NO	400Hz	32,00 \$
LR18TBF08DNOY-E2	M18X1	M12 KONNEKTÖR	DÜZ	4mm	PNP	NO	400Hz	32,00 \$
LR18TBN12DPOY	M18X1	2m KABLO	ÇIKIK	2mm	PNP	NO	400Hz	30,00 \$
LR18TBN12DNOY	M18X1	2m KABLO	ÇIKIK	2mm	NPN	NO	400Hz	30,00 \$
LR18TBN12DPOY-E2	M18X1	M12 KONNEKTÖR	ÇIKIK	4mm	PNP	NO	400Hz	32,00 \$
LR18TBN12DNOY-E2	M18X1	M12 KONNEKTÖR	ÇIKIK	4mm	NPN	NO	400Hz	32,00 \$
<b>UZUN SERİ ARTTIRILMIŞ ALGILAMA</b>								
LR18TCF12DPOY	M18X1	2m KABLO	DÜZ	12mm	PNP	NO	400Hz	56,00 \$
LR18TCF12DNOY	M18X1	2m KABLO	DÜZ	12mm	NPN	NO	400Hz	56,00 \$
LR18TCF12DPOY-E2	M18X1	M12 KONNEKTÖR	DÜZ	12mm	PNP	NO	400Hz	56,00 \$
LR18TCF12DNOY-E2	M18X1	M12 KONNEKTÖR	DÜZ	12mm	NPN	NO	400Hz	56,00 \$
LR18TCN20DPOY	M18X1	2m KABLO	DÜZ	20mm	PNP	NO	400Hz	56,00 \$
LR18TCN20DNOY	M18X1	2m KABLO	DÜZ	20mm	NPN	NO	400Hz	56,00 \$
LR18TCN20DPOY-E2	M18X1	M12 KONNEKTÖR	DÜZ	20mm	PNP	NO	400Hz	56,00 \$
LR18TCN20DNOY-E2	M18X1	M12 KONNEKTÖR	DÜZ	20mm	NPN	NO	400Hz	56,00 \$

### Genel Özellikler:

Çalışma gerilimi : 10-30VDC  
 Çalışma sıcaklığı : -25...+70°C  
 IP 67 Koruma sınıfı  
 Kısa devre ve faz dalgalanmalarına karşı korumalı

\*\* Modeller kısa gövdedir

## SOLID STATE RÖLELER

## DC GİRİŞ / AC ÇIKIŞ MONOFAZE



ÜRÜN KODU	ÇIKIŞ AKIMI	GİRİŞ (V)	ÇIKIŞ (V)	İÇ YAPISI	ADET (\$)
TRRS1A40D10	10 A	3-32 VDC	24-480 VAC	TRIAC	7,00 \$
TRRS1A40D25	25 A	3-32 VDC	24-480 VAC	TRIAC	10,00 \$
TRRS1A40D40	40 A	3-32 VDC	24-480 VAC	TRIAC	13,00 \$
TRRS1A40D50	50 A	3-32 VDC	24-480 VAC	TRIAC	20,00 \$
TRRS1A40D60	60 A	3-32 VDC	24-480 VAC	TRIAC	23,00 \$
TRRS1A40D80	80 A	3-32 VDC	24-480 VAC	TRIAC	30,00 \$
TRRS1A40D100	100 A	3-32 VDC	24-480 VAC	TRIAC	35,00 \$
TRRS1A40D125	125 A	3-32 VDC	24-480 VAC	TRIAC	44,00 \$

## AC GİRİŞ / AC ÇIKIŞ MONOFAZE



ÜRÜN KODU	ÇIKIŞ AKIMI	GİRİŞ (V)	ÇIKIŞ (V)	İÇ YAPISI	ADET (\$)
TRM1A40A25	25 A	20-280 VAC	42-440 VAC	SCR	12,00 \$
TRM1A40A50	50 A	20-280 VAC	42-440 VAC	SCR	21,00 \$
TRM1A40A75	75 A	20-280 VAC	42-440 VAC	SCR	28,00 \$
TRM1A40A100	100 A	20-280 VAC	42-440 VAC	SCR	38,00 \$
TRM1A40A125	125 A	20-280 VAC	42-440 VAC	SCR	46,00 \$

## POTANSİYOMETRE GİRİŞ / AC ÇIKIŞ MONOFAZE



ÜRÜN KODU	ÇIKIŞ AKIMI	GİRİŞ (V)	ÇIKIŞ (V)	İÇ YAPISI	ADET (\$)
TRS1A23VR25	25 A	0-500k	230 VAC	TRIAC	14,00 \$
TRS1A23VR40	40 A	0-500k	230 VAC	TRIAC	16,00 \$
TRS1A23VR60	60 A	0-500k	230 VAC	TRIAC	26,00 \$
TRS1A23VR80	80 A	0-500k	230 VAC	TRIAC	30,00 \$
TRS1A23VR2100	100 A	0-500k	230 VAC	TRIAC	38,00 \$

## ANALOG GİRİŞ / AC ÇIKIŞ MONOFAZE



ÜRÜN KODU	ÇIKIŞ AKIMI	GİRİŞ (V)	ÇIKIŞ (V)	İÇ YAPISI	ADET (\$)
TRS1E23AA25	25 A	4-20 mA	90-440 VAC	TRIAC	20,00 \$
TRS1E23AA40	40 A	4-20 mA	90-440 VAC	TRIAC	25,00 \$
TRS1E23AA60	60 A	4-20 mA	90-440 VAC	TRIAC	35,00 \$
TRS1E23AA100	100 A	4-20 mA	90-440 VAC	TRIAC	50,00 \$

## DC GİRİŞ / DC ÇIKIŞ MONOFAZE



ÜRÜN KODU	ÇIKIŞ AKIMI	GİRİŞ (V)	ÇIKIŞ (V)	İÇ YAPISI	ADET (\$)
TSSR-10DD-H	10 A	4-32 VDC	5-200 VDC	MOSFET	20,00 \$
TSSR-25DD-H	25 A	4-32 VDC	5-200 VDC	MOSFET	25,00 \$
TSSR-40DD-H	40 A	4-32 VDC	5-200 VDC	MOSFET	35,00 \$
TSSR-60DD-H	60 A	4-32 VDC	5-200 VDC	MOSFET	50,00 \$

## SOLID STATE RÖLELER

### DC GİRİŞ / AC ÇIKIŞ MONOFAZE



ÜRÜN KODU	ÇIKIŞ AKIMI	GİRİŞ (V)	ÇIKIŞ (V)	İÇ YAPISI	ADET (\$)
TDR-DA4815H	15 A	3-32 VDC	24-480 VAC	TRIAC	20,00 \$
TDR-DA4825H	25 A	3-32 VDC	24-480 VAC	TRIAC	24,00 \$
TDR-DA4840H	40 A	3-32 VDC	24-480 VAC	TRIAC	26,00 \$
TDR-DA4850H	50 A	3-32 VDC	24-480 VAC	TRIAC	29,00 \$
TDR-DA4860H	60 A	3-32 VDC	24-480 VAC	TRIAC	35,00 \$

### DC GİRİŞ / AC ÇIKIŞ MONOFAZE



ÜRÜN KODU	ÇIKIŞ AKIMI	GİRİŞ (V)	ÇIKIŞ (V)	İÇ YAPISI	ADET (\$)
TH3120ZF	120 A	3-32 VDC	24-480 VAC	SCR	45,00 \$
TH3150ZF	150 A	3-32 VDC	24-480 VAC	SCR	52,00 \$
TH3200ZF	200 A	3-32 VDC	24-480 VAC	SCR	59,00 \$
TH3250ZF	250 A	3-32 VDC	24-480 VAC	SCR	70,00 \$
TH3400ZF	400 A	3-32 VDC	24-480 VAC	SCR	110,00 \$

### DC GİRİŞ / AC ÇIKIŞ TRİFAZE

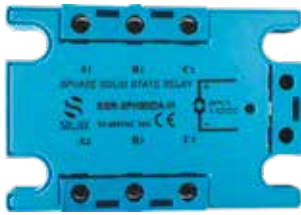

ÜRÜN KODU	ÇIKIŞ AKIMI	GİRİŞ (V)	ÇIKIŞ (V)	İÇ YAPISI	ADET (\$)
SSR-3PH25DA-H	25 A	4-32 VDC	90-480 VAC	SCR	48,00 \$
SSR-3PH50DA-H	50 A	4-32 VDC	90-480 VAC	SCR	56,00 \$
SSR-3PH80DA-H	80 A	4-32 VDC	90-480 VAC	SCR	85,00 \$
SSR-3PH100DA-H	100 A	4-32 VDC	90-480 VAC	SCR	105,00 \$
SSR-3PH125DA-H	125 A	4-32 VDC	90-480 VAC	SCR	115,00 \$
SSR-3PH150DA-H	150 A	4-32 VDC	90-480 VAC	SCR	130,00 \$

## SSR İÇİN ALÜMİNYUM SOĞUTUCULAR



T-50 TİPİ  
YÜZEYE MONTAJ MONOFAZE

ÜRÜN KODU	ÖLÇÜ (mm)	MONTAJ ŞEKLİ	ADET (\$)
TYPE T-50	54 x 60 x 50	TABANA MONTAJ	7,00 \$
TYPE I-77	77 x 44 x 75	RAY MONTAJ	13,00 \$
TYPE M132	100 x 130 x 82	TABANA MONTAJ	20,00 \$
TYPE M150	100 x 150 x 82	TABANA MONTAJ	22,00 \$



I-77 TİPİ  
RAYA MONTAJ MONOFAZE



M TİPİ  
YÜZEYE MONTAJ TRİFAZE

## Ø22 mm SİNYAL LAMBASI LED



ÜRÜN KODU	AÇIKLAMA	RENK	FİYAT	KUTU ADEDİ
<b>220 VAC</b>				
ASG-AD22-42220	Ø 22 mm, LED, 220 VAC	Kırmızı	⌚	10
ASG-AD22-31220	Ø 22 mm, LED, 220 VAC	Yeşil		10
ASG-AD22-51220	Ø 22 mm, LED, 220 VAC	Sarı		10
ASG-AD22-61220	Ø 22 mm, LED, 220 VAC	Mavi		10
ASG-AD22-11220	Ø 22 mm, LED, 220 VAC	Beyaz		10
<b>24 VDC</b>				
ASG-AD22-3124	Ø 22 mm, LED, 24 V DC	Yeşil	⌚	10
ASG-AD22-4224	Ø 22 mm, LED, 24 V DC	Kırmızı		10
ASG-AD22-5124	Ø 22 mm, LED, 24 V DC	Sarı		10

## Ø22 mm VOLTMETRELİ SİNYAL LAMBASI LED



ÜRÜN KODU	AÇIKLAMA	ÇALIŞMA ARALIĞI	RENK	ADET (t)	KUTU ADEDİ
AD22VM-42220	Ø 22 mm, LED, 220 VAC	50-500 VAC	Kırmızı	⌚	10
AD22VM-31220	Ø 22 mm, LED, 220 VAC	50-500 VAC	Yeşil		10
AD22VM-51220	Ø 22 mm, LED, 220 VAC	50-500 VAC	Sarı		10

## Ø10 mm SİNYAL LAMBASI LED 220V



ÜRÜN KODU	AÇIKLAMA	RENK	FİYAT	KUTU ADEDİ
AD10-31220	Ø 10 mm, LED, 220 VAC	Kırmızı	⌚	10
AD10-42220	Ø 10 mm, LED, 220 VAC	Yeşil		10
AD10-51220	Ø 10 mm, LED, 220 VAC	Sarı		10

## BUZZERLER (Ø 22 mm LED'li Buzzer 90 dB)



ÜRÜN KODU	AÇIKLAMA	RENK	FİYAT	KUTU ADEDİ
AD22-220SM/R	Ø 22 mm Sesli-Led Flaşör İkazlı 220 V AC	●	⌚	10
AD22-24SM/R	Ø 22 mm Sesli-Led Flaşör İkazlı 24 V AC-DC	●		10

## SİRENLER



ÜRÜN KODU	AÇIKLAMA	RENK	FİYAT	KUTU ADEDİ
<b>Ø 50 mm Siren (120 dB)</b>				
PS-101,12-24 V	Siren 12 - 24 V AC/DC Plastik Gövde	●	⌚	1
PS-101, 220 V	Siren 220V AC Plastik Gövde	●		1
ES-220, 12 V	Siren 12V DC Plastik Gövde	●		1

## HOPARLÖR



ÜRÜN KODU	AÇIKLAMA	FİYAT	KUTU ADEDİ
SP-57 / 0.5 w	57 mm Çap, 8 ohm 0.5 W Hoparlör	⌚	100
SP-77 / 1 w	77 mm Çap, 8 ohm 1 W Hoparlör		100

## KÖPRÜ DİYOT



ÜRÜN KODU	AÇIKLAMA	FİYAT	KUTU ADEDİ
KBPC-3510	35 A / 1000 V	⌚	50
KBPC-5010	50 A / 1000 V		50

## LAY5 SERİSİ (Ø22 mm Butonlar)

YAYLI BUTON 3A / 240 V AC, IP 44

### PLASTİK BUTON SERİSİ



ÜRÜN KODU	RENK	AÇIKLAMA	KONTAK	FİYAT	KUTU ADEDİ
LAY5-EA31	●	Start Buton	NO	⌚	20
LAY5-EA42	●	Stop Buton	NC		20
LAY5-EA51	●	Start Buton	NO		20
LAY5-EA61	●	Start Buton	NO		20
LAY5-EA21	●	Start Buton	NO		20
LAY5-EA2351	⚠	Start Buton	NO		20
LAY5-EA7321	☀	Start Buton	NO		20
LAY5-EA3341	↑	Start Buton	NO		20
LAY5-EA3351	↓	Start Buton	NO		20
LAY5-EA6361	↕	Start Ortak Buton	NO		20
LAY5-EL8325	■	Start Stop İkiz Buton	NO+NC		20
LAY5-EL3371	↑ ↓	Start İkiz Buton Oklu	NO+NO		20

### METAL BUTON SERİSİ



ÜRÜN KODU	RENK	AÇIKLAMA	KONTAK	FİYAT	KUTU ADEDİ
LAY5-BA31	●	Start Buton	NO	⌚	20
LAY5-BA42	●	Stop Buton	NC		20
LAY5-BA51	●	Start Buton	NO		20
LAY5-BA61	●	Start Buton	NO		20
LAY5-BA21	●	Start Buton	NO		20
LAY5-BA2351	⚠	Start Buton	NO		20
LAY5-BA7321	☀	Start Buton	NO		20
LAY5-BA3341	↑	Start Buton	NO		20
LAY5-BA3351	↓	Start Buton	NO		20
LAY5-BA6361	↕	Start Ortak Buton	NO		20
LAY5-BL8325	■	Start Stop İkiz Buton	NO+NC		20
LAY5-BL3371	↑ ↓	Start İkiz Buton Oklu	NO+NO		20

## LAY5 SERİSİ (Ø22 mm Butonlar)

### PLASTİK BUTON SERİSİ

MANTAR BUTON 3A / 240 V AC,  
IP 44



ÜRÜN KODU	AÇIKLAMA	KONTAK	FİYAT	KUTU ADEDİ
LAY5-ES542	Acil Stop Buton Kırmızı	NC	⌚	20

### METAL BUTON SERİSİ

MANTAR BUTON 3A / 240 V AC,  
IP 44



ÜRÜN KODU	AÇIKLAMA	KONTAK	FİYAT	KUTU ADEDİ
LAY5-BS542	Acil Stop Buton Kırmızı	NC	⌚	20

MANDAL BUTON 3A / 240 V AC,  
IP 44



ÜRÜN KODU	AÇIKLAMA	KONTAK	FİYAT	KUTU ADEDİ
LAY5-EJ21	Mandal Buton Uzun 0-1	NO	⌚	20
LAY5-ED21	Mandal Buton Kısa 0-1	NO		20
LAY5-ED33	Mandal Buton Kısa 1-0-2	2 NO		20
LAY5-ED53	Mandal Buton Kısa 1-0-2	2NO		20

MANDAL BUTON 3A / 240 V AC,  
IP 44

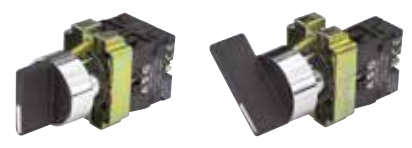

ÜRÜN KODU	AÇIKLAMA	KONTAK	FİYAT	KUTU ADEDİ
LAY5-BJ21	Mandal Buton Uzun 0-1	NO	⌚	20
LAY5-BD21	Mandal Buton Kısa 0-1	NO		20
LAY5-BD33	Mandal Buton Kısa 1-0-2	2 NO		20
LAY5-BD41	Mandal Buton Kısa 0-1	2NO		20

## LAY5 SERİSİ (Ø22 mm Butonlar)



YEDEK KONTAK  
3A / 240 V AC, IP 44



ANAHTARLI BUTON  
3A / 240 V AC, IP 44

ÜRÜN KODU	AÇIKLAMA	FİYAT	KUTU ADEDİ
LAY5-BE101	Kontakt Bloğu NO	⚡	150
LAY5-BE102	Kontakt Bloğu NC		150

ÜRÜN KODU	AÇIKLAMA	KONTAK	FİYAT	KUTU ADEDİ
LAY5-BG21	Anahtarlı Buton 0-1	NO	⚡	20
LAY5-BG73	Anahtarlı Buton 1-0-2 Sağa-Sola Kayıcı	2NO		20
LAY5-EG61	Anahtarlı Buton 0-1 Kayıcı	NO		20
LAY5-EG73	Anahtarlı Buton 1-0-2 Sağa-Sola Kayıcı	2NO		20
LAY5-BG61	Anahtarlı Buton 0-1 Kayıcı	NO		20

## MİNİ RÖLE ve SOKET

### 1 Kontak 5 Pin Minyatür Röle



İğne Bacaklı,  
10A

ÜRÜN KODU	AÇIKLAMA	FİYAT	KUTU ADEDİ
JQX-14FC-1Z-24V	1 Kontak, 5 Pin Minyatür Röle, İğne Bacaklı 24 V DC	⚡	100
JQX-14FC-1Z-220V	1 Kontak, 5 Pin Minyatür Röle, İğne Bacaklı 220 V AC		100

### 2 Kontak 8 Pin Minyatür Röle



İğne Bacaklı,  
5A

ÜRÜN KODU	AÇIKLAMA	FİYAT	KUTU ADEDİ
JQX-14FC-1Z-12V	2 Kontak, 8 Pin Minyatür Röle, İğne Bacaklı 12 V DC	⚡	100
JQX-14FC-2Z-24V	2 Kontak, 8 Pin Minyatür Röle, İğne Bacaklı 24 V DC		100
JQX-14FC-2Z-220V	2 Kontak, 8 Pin Minyatür Röle, İğne Bacaklı 220 V AC		100

### 5 Pin Röle Soketi



ÜRÜN KODU	AÇIKLAMA	FİYAT	KUTU ADEDİ
14F-1Z-C2	5 Pin Tek Kontak Röle Soketi Kısa, Raya Montaj	⚡	20

### 8 Pin Röle Soketi



ÜRÜN KODU	AÇIKLAMA	FİYAT	KUTU ADEDİ
14F-2Z-C2	8 Pin Çift Kontak Röle Soketi Kısa, Raya Montaj	⚡	20
14F-2Z-C3	8 Pin Çift Kontak Röle Soketi, Raya Montaj Röle Tutucu		20

## ASANSÖRLER İÇİN MİKNATISLAR

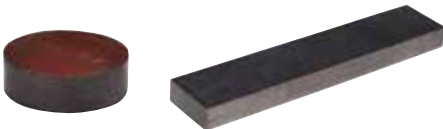

ÜRÜN KODU	AÇIKLAMA	FİYAT	KUTU ADEDİ
22x7	22 mm Çap, 7 mm Yükseklik, Kırmızı Boyalı Yuvarlak Mıknatıs	⚡	1500
10 cm Şerit Mıknatıs	20 mm en, 8 mm Yükseklik, Şerit Mıknatıs		360
30 cm Şerit Mıknatıs	20 mm en, 8 mm Yükseklik, Şerit Mıknatıs		120

## LAY5 SERİSİ TEKLİ KUMANDA KUTUSU



ÜRÜN KODU	AÇIKLAMA	KONTAK	FİYAT	KUTU ADEDİ
LAY5-ESBK542	Emergency stop muhafazalı (EKO SERİ)	NC	⚡	100
LAY5-J174H29P	Emergency stop muhafazalı	NC		100
LAY5-JHEA21	1'li boş kutuya monte aydınlatma butonu	NO		100
LAY5-JHEG61	1'li boş kutuya monte kuyu dışından revizyon reset anahtar	NO		100
LAY5-JH24SM/R	1'li boş kutuya monte 24VDC Bypass buzzer	NO		100

## LAY5 SERİSİ 4'LÜ KUMANDA KUTUSU (Asansörler İçin)



ÜRÜN KODU	AÇIKLAMA	FİYAT	KUTU ADEDİ
LAY5-EJ140	4'lü Plastik Butonlu, Miknats Tabanlı El Kumanda Butonu	⚡	30
LAY5-EJ151	5'li Plastik Butonlu, Miknats Tabanlı El Kumanda Butonu		30
LAY5-EJ1451	6'li Plastik Butonlu, Miknats Tabanlı El Kumanda Butonu		30

## LAY5-HBX SERİSİ BOŞ KUTULAR (YÜKSEK TİP)

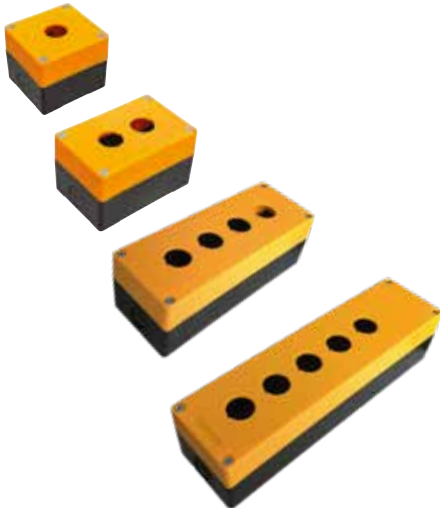

ÜRÜN KODU	AÇIKLAMA	FİYAT	KUTU ADEDİ
LAY5-JHBX1	1'li Sarı Siyah Boş Kutu	⚡	100
LAY5-JHBX2	2'li Sarı Siyah Boş Kutu		100
LAY5-JHBX3	3'lü Sarı Siyah Boş Kutu		75
LAY5-JHBX4	4'lü Sarı Siyah Boş Kutu		50
LAY5-JHBX5	5'li Sarı Siyah Boş Kutu		50
LAY5-JHBX6	6'li Sarı Siyah Boş Kutu		50



**BAKIR İLETKENLER İÇİN REÇİNELİ KABLO EK MUFLARI (0.6 - 1 kV)****ŞEFFAF REÇİNELİ KABLO EK MUFLARI (0.6 - 1 kV)****PROTOLİNLER / REÇİNELER****A.G. PABUÇLU REÇ. KAB. BAŞLIKLARI (0.6 - 1 kV)****O.G. 3 DAMARLI HARİCİ ISI BÜZ. KAB. BAŞ. (20.8-36 kV)****FERMUARLI ISI BÜZ. KAB. EK MUF (0.6 - 1 kV)****PLASTİK HUNİ KALIPLARI****BAKIR İLETKENLER İÇİN ISI BÜZÜŞMELİ KABLO EK MUFLARI (0.6 - 1 kV)**

## ISI İLE DARALAN MAKARON SEÇİM TABLOSU

ÜRÜN YUVARLAK BORU FORMUNDA İÇ ÇAP DARALMA ÖNCESİ (mm)	ÜRÜN YUVARLAK BORU FORMUNDA İÇ ÇAP DARALMA SONRASI (mm)	Dikdörtgen kesitli BARAYA UYGUNLUK (mm)	Kablo ve Pabucuna Uygunluk 1 damar kesiti (mm <sup>2</sup> )	PAKET RULO MİKTARI (mt)
1,5	0,75		1 mm ve altı	200
2,5	1,25		0,5-0,75	200
3,5	1,75		0,75-1-1,5	200
4,5	2,25		1,5-2,5	100
5	2,5		2,5	100
6	3		4-6	100
7	3,5		6	100
8	4		6-10	100
10	5		10-16	100
12	6		10-16	100
13	6,5	12X2-15X2-15X3	16-25	100
16	8	20X2-20X3	16-25-35-50	100
18	9	20X5	35-50	100
20	10	20X5-25X3-25X5	70	100
22	11	25X5-30X3-30X5	70-95	100
25	12,5	25X5-30X3-30X5	70-95	50
28	14	40X3	70-95	50
30	15	40X3-40X5	120	50
32	16	30X10-40X5	120-150	50
35	17,5	30X10-40X5-40X10	150	50
38	19	40X5-40X10	185-240	50
40	20	50X5	185-240-300	50
45	22,5	50X5-50X10	240-300-400	25
50	25	60X5-60X10	400	25
60	30	80X5-80X10		25
70	35	100X5-100X10		25
80	40	100X5-100X10		25
90	45	100X10		25
100	50	120X10		25
120	60	120X10-160X10		25
150	75	160X10		25



SİPARİŞ ESNASINDA RENK BELİRTİNİZ!

11 Siyah	12 Sarı/Yeşil	13 Kırmızı	14 Sarı	15 Mavi	16 Yeşil	17 Gri	18 Kahve	19 Beyaz	20 Şeffaf
----------	---------------	------------	---------	---------	----------	--------	----------	----------	-----------

## POLİOLEFİN MALZEMEDEN İMAL 2/1 ORANINDA DARALAN MAKARON



UL-1 SERTİFİKALI RoHS, ISO BELGELİ, 600 V  
ÇALIŞMA SICAKLIĞI -55 °C + 125 °C



### Baraya Uygun Makarón Çap Hesabı

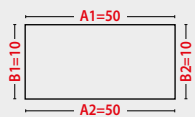

$$\frac{50+50+10+10}{\pi : 3,14} = 40\text{mm}$$

$$\frac{A1+A2+B1+B2}{\pi : 3,14} = \varnothing$$

\* Siparişinizde makaron rengi belirtiniz.  
\* Kullandığınız üründe radius var ise hesaplamamız gözden geçirin.

Ölçüler		Daralmadan Önce (mm)		Daralmadan Sonra (mm)		Metre Fiyatı (\$)	Makara (m)
Inc (Ø)	mm	İç Çap	Cidar Kalınlığı	İç Çap	Cidar Kalınlığı		
3 / 64	0.8	1,1 ± 0,2	0,15 ± 0,05	0,40	0,28 ± 0,10	0,165 \$	200
	1	1,5 ± 0,2	0,15 ± 0,05	0,50	0,28 ± 0,10	0,090 \$	200
	1.2	2,0 ± 0,2	0,15 ± 0,05	0,70	0,30 ± 0,10	0,090 \$	200
	1.5	2,0 ± 0,2	0,18 ± 0,05	0,85	0,32 ± 0,10	0,097 \$	200
1 / 16	1.6	2,0 ± 0,3	0,15 ± 0,05	0,80	0,28 ± 0,10	0,104 \$	200
	2	2,5 ± 0,2	0,18 ± 0,05	0,60	0,28 ± 0,10	0,115 \$	200
3 / 32	2.4	3,0 ± 0,3	0,18 ± 0,05	1,20	0,35 ± 0,10	0,115 \$	200
	2.5	3,0 ± 0,2	0,18 ± 0,05	1,30	0,38 ± 0,10	0,150 \$	200
	3	3,5 ± 0,2	0,18 ± 0,05	1,50	0,40 ± 0,10	0,160 \$	200
1 / 8	3.2	3,5 ± 0,4	0,18 ± 0,05	1,60	0,40 ± 0,10	0,160 \$	200
	3.5	4,0 ± 0,2	0,22 ± 0,05	1,80	0,42 ± 0,10	0,170 \$	200
	4	4,5 ± 0,2	0,25 ± 0,05	2,00	0,45 ± 0,10	0,200 \$	200
3 / 16	4.5	5,0 ± 0,2	0,25 ± 0,05	2,30	0,50 ± 0,10	0,230 \$	100
	4.8	5,2 ± 0,4	0,25 ± 0,05	2,40	0,50 ± 0,10	0,230 \$	100
	5	5,5 ± 0,2	0,25 ± 0,05	2,50	0,55 ± 0,10	0,250 \$	100
1 / 4	6	6,5 ± 0,2	0,28 ± 0,05	3,00	0,55 ± 0,10	0,290 \$	100
	6.4	7,0 ± 0,4	0,28 ± 0,05	3,20	0,55 ± 0,10	0,290 \$	100
	7	7,5 ± 0,3	0,28 ± 0,05	3,50	0,55 ± 0,10	0,350 \$	100
3 / 8	8	8,5 ± 0,3	0,28 ± 0,05	4,00	0,60 ± 0,10	0,350 \$	100
	9	9,5 ± 0,3	0,30 ± 0,08	4,50	0,60 ± 0,10	0,360 \$	50
	9.5	10,0 ± 0,5	0,30 ± 0,08	4,80	0,60 ± 0,10	0,360 \$	100
1 / 2	10	10,5 ± 0,3	0,30 ± 0,08	5,00	0,60 ± 0,10	0,390 \$	100
	11	11,5 ± 0,3	0,30 ± 0,08	5,50	0,60 ± 0,10	0,442 \$	100
	12	12,5 ± 0,3	0,30 ± 0,08	6,00	0,60 ± 0,10	0,450 \$	100
3 / 4	12.7	13,0 ± 0,5	0,30 ± 0,08	6,40	0,60 ± 0,10	0,450 \$	100
	13	13,5 ± 0,3	0,35 ± 0,10	6,50	0,65 ± 0,10	0,500 \$	100
	14	14,5 ± 0,3	0,35 ± 0,10	7,00	0,65 ± 0,10	0,580 \$	100
4 / 5	15	15,5 ± 0,3	0,35 ± 0,10	7,00	0,65 ± 0,10	0,675 \$	100
	16	16,5 ± 0,4	0,40 ± 0,12	8,00	0,70 ± 0,10	0,750 \$	100
	17	17,5 ± 0,4	0,40 ± 0,12	8,50	0,70 ± 0,10	0,975 \$	100
1	18	19,0 ± 0,5	0,40 ± 0,15	9,00	0,80 ± 0,15	0,980 \$	100
	19.1	20,5 ± 0,6	0,40 ± 0,15	9,50	0,80 ± 0,15	0,980 \$	100
	20	21,0 ± 0,6	0,40 ± 0,15	10,00	0,80 ± 0,15	1,250 \$	100
1-1 / 4	22	23,0 ± 0,5	0,40 ± 0,15	11,00	0,80 ± 0,15	1,560 \$	100
	25.4	25,6 ± 0,7	0,45 ± 0,12	14,00	0,90 ± 0,15	1,650 \$	50
	30	31,5 ± 1,0	0,50 ± 0,15	15,00	0,90 ± 0,15	2,150 \$	50
1-1 / 2	32	33,0 ± 0,7	0,50 ± 0,15	15,90	0,95 ± 0,15	2,150 \$	50
	35	36,5 ± 1,0	0,50 ± 0,15	17,50	0,95 ± 0,15	2,800 \$	50
2	38	40,0 ± 0,7	0,50 ± 0,15	19,10	1,00 ± 0,15	3,000 \$	50
	40	41,5 ± 1,0	0,55 ± 0,15	20,00	1,00 ± 0,15	3,000 \$	50
	51	52,5 ± 0,7	0,55 ± 0,15	25,40	0,95 ± 0,15	3,800 \$	25
3	60	60	0,60 ± 0,15	30,00	1,30 ± 0,20	5,100 \$	25
	70	70	0,65 ± 0,15	35,00	1,30 ± 0,20	6,900 \$	25
	76	80,0 ± 1,0	0,65 ± 0,15	38,10	1,30 ± 0,20	7,500 \$	25
4	80	80	0,65 ± 0,15	40,00	1,46 ± 0,20	7,500 \$	25
	90	90	0,65 ± 0,15	45,00	1,46 ± 0,20	8,500 \$	25
	96	100	0,65 ± 0,15	50,00	1,46 ± 0,20	9,500 \$	25
5	102	105,0 ± 1,0	0,65 ± 0,20	50,80	1,46 ± 0,20	9,500 \$	25
	120	120	0,65 ± 0,20	63,50	1,56 ± 0,20	13,000 \$	25
	150	150	0,65 ± 0,20	75,00	1,56 ± 0,20	20,000 \$	25
250	180	180	0,65 ± 0,30	90,00	1,56 ± 0,20	28,000 \$	25
	250	250	0,65 ± 0,30	125,00	1,56 ± 0,20	55,000 \$	20



## 2/1 RENKLİ ISI İLE DARALAN MAKARON



Renkler	Inc	mm	Metre Fiyatı (\$)	Makara (m)	Kahverengi Metre Fiyatı (\$)	Sarı - Yeşil Metre Fiyatı (\$)
Beyaz	1/16	1,6	0,10 \$	200	0,12 \$	0,60 \$
		2,0	0,14 \$	200	-	-
	3/32	2,4	0,15 \$	200	0,16 \$	0,42 \$
		2,5	0,16 \$	200	0,18 \$	-
Sarı	1/8	3,2	0,19 \$	200	0,22 \$	0,43 \$
		3,5	0,21 \$	200	0,27 \$	0,44 \$
Mavi	3/16	4,8	0,26 \$	100	0,29 \$	0,44 \$
		5	0,30 \$	100	-	-
	1/4	6,4	0,33 \$	100	0,37 \$	0,50 \$
		7	0,38 \$	100	-	-
Kırmızı	3/8	9,5	0,40 \$	100	0,45 \$	0,68 \$
		1/2	12,7	0,52 \$	100	0,57 \$
	1	16	0,86 \$	100	1,00 \$	1,46 \$
		3/4	19,1	1,38 \$	100	1,42 \$
Yeşil	4/5	20	1,50 \$	100	1,57 \$	1,86 \$
		1	25,4	1,86 \$	50	2,10 \$
	1-1/4	32	2,43 \$	50	2,70 \$	3,70 \$
		35	3,40 \$	50	3,90 \$	4,50 \$
Şeffaf	1-1/2	38	3,50 \$	50	4,00 \$	5,00 \$
		40	3,80 \$	40	-	5,50 \$
	2	51	4,20 \$	50	5,00 \$	7,00 \$
		60	6,00 \$	25	7,40 \$	10,35 \$
Gri	3	76	8,30 \$	25	9,00 \$	16,00 \$
		96	12,10 \$	25	-	-
	4	102	12,10 \$	25	13,00 \$	25,50 \$
		5	120	22,00 \$	25	25,00 \$
		150	30,00 \$	25	35,00 \$	45,00 \$
		180	45,00 \$	25	45,00 \$	55,00 \$

## 3/1 İÇİ YAPIŞKANLI DARALAN MAKARON



### Baraya Uygun Makaron Çap Hesabı

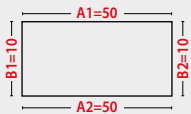

$$\frac{50+50+10+10}{\pi : 3,14} = 40\text{mm}$$

$$\frac{A1+A2+B1+B2}{\pi : 3,14} = \varnothing$$

\* Siparişinizde makaron rengi belirtiniz.  
\* Kullandığınız üründe radius var ise hesaplamanızı gözden geçirin.

İnç	Ölçü		Uygulama Sonrası			Metre Fiyatı (\$)	Makara (m)
	mm	Daralmadan Önce İç Çap (mm)	Daralmadan Sonra İç Çap (mm)	Yapışkanın Cidar Kalınlığı (mm)	Toplam Cidar Kalınlığı (mm)		
3/32	2.4	2.4	0.8	0,40 ± 0,10	0,85 ± 0,15	0,65 \$	200 m
1/8	3.2	3.2	1,0	0,40 ± 0,10	0,95 ± 0,15	0,65 \$	200 m
3/16	4.8	4.8	1,6	0,40 ± 0,10	1,10 ± 0,15	0,80 \$	100 m
1/4	6.4	6.4	2,2	0,45 ± 0,12	1,20 ± 0,15	1,15 \$	100 m
3/8	9.5	9.5	3,2	0,50 ± 0,12	1,45 ± 0,20	1,70 \$	50 m
1/2	12.7	12.7	4,2	0,50 ± 0,12	1,70 ± 0,20	2,20 \$	1.22 Boy
5/8	16	16	5,5	0,55 ± 0,15	1,80 ± 0,20	3,00 \$	1.22 Boy
3/4	19.1	19.1	6,3	0,55 ± 0,15	2,00 ± 0,20	4,50 \$	1.22 Boy
1	25.4	25.4	8,5	0,60 ± 0,15	2,10 ± 0,25	4,60 \$	1.22 Boy
-	28	28	10,0	0,60 ± 0,15	2,20 ± 0,25	5,10 \$	1.22 Boy
1-1/4	30	30	10,2	0,60 ± 0,15	2,20 ± 0,25	5,50 \$	1.22 Boy
-	33	33	11,0	0,60 ± 0,15	2,20 ± 0,25	5,70 \$	1.22 Boy
-	40	40	13,3	0,60 ± 0,15	2,40 ± 0,25	6,50 \$	1.22 Boy
-	44	44	14,6	0,60 ± 0,15	2,40 ± 0,25	7,20 \$	1.22 Boy
-	52	52	17,3	0,70 ± 0,15	2,70 ± 0,25	8,00 \$	1.22 Boy
-	70	70	23,3	1,00 ± 0,20	3,00 ± 0,30	11,30 \$	1.22 Boy
7/2	90	90	30,0	1,00 ± 0,20	3,00 ± 0,30	16,00 \$	1.22 Boy
5	125	125	41,6	1,00 ± 0,20	3,00 ± 0,30	25,00 \$	1.22 Boy

## 2.5 KV CAM ELYAF MAKARONLAR

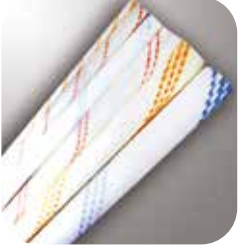

**BEYAZ ÜZERİ  
ÇİZGİLİ - SİYAH**



**İzolasyon Sınıfı: 8  
Çalışma Sıcaklığı:  
-25 °C / 130 °C**

ÜRÜN KODU	Çap (mm)	Metre Fiyatı (\$)	Rulo (m)
FG-VG 0.80	0.70	0,119 \$	100
FG-VG 1.00	1.00	0,119 \$	100
FG-VG 1.50	1.50	0,126 \$	100
FG-VG 2.00	2.00	0,143 \$	100
FG-VG 2.50	2.50	0,157 \$	100
FG-VG 3.00	3.00	0,230 \$	100
FG-VG 4.00	4.00	0,286 \$	100
FG-VG 5,00	5,00	0,415 \$	100
FG-VG 6.00	6.00	0,487 \$	50
FG-VG 7.00	7.00	0,572 \$	50
FG-VG 8.00	8.00	0,686 \$	50
FG-VG 10.00	10.00	0,887 \$	50
FG-VG 12.00	12.00	1,145 \$	50
FG-VG 14.00	14.00	1,430 \$	50
FG-VG 16.00	16.00	1,730 \$	50
FG-VG 18.00	18.00	1,917 \$	50
FG-VG 20.00	20.00	2,520 \$	25
FG-VG 25.00	25.00	3,990 \$	25

## 2.5 KV H CLASS CAM-SİLİKON MAKARONLAR



**KIRMIZI - SİYAH**



**İzolasyon Sınıfı:  
H Class  
Çalışma Sıcaklığı:  
-60 °C / 230 °C**

ÜRÜN KODU	Çap (mm)	Metre Fiyatı (\$)	Rulo (m)
FG-SRG 0.70	0.70	0,315 \$	100
FG-SRG 1.00	1.00	0,315 \$	100
FG-SRG 1.50	1.50	0,345 \$	100
FG-SRG 2.00	2.00	0,375 \$	100
FG-SRG 2.50	2.50	0,450 \$	100
FG-SRG 3.00	3.00	0,660 \$	100
FG-SRG 3.50	3.50	0,750 \$	100
FG-SRG 4.00	4.00	0,825 \$	100
FG-SRG 5,00	5,00	0,938 \$	100
FG-SRG 6.00	6.00	1,125 \$	100
FG-SRG 7.00	7.00	1,500 \$	100
FG-SRG 8.00	8.00	1,725 \$	100
FG-SRG 10.00	10.00	2,235 \$	100
FG-SRG 12.00	12.00	3,000 \$	50
FG-SRG 14.00	14.00	4,125 \$	50
FG-SRG 16.00	16.00	4,875 \$	50
FG-SRG 18.00	18.00	5,813 \$	50
FG-SRG 20.00	20.00	7,463 \$	25
FG-SRG 25.00	25.00	13,088 \$	25

## KABLO TOPLAMA ÇORABI



ÜRÜN KODU	Min. Tutma Çapı	Max. Tutma Çapı	Rulo (m)	Renk	Metre Fiyatı (\$)	Renkli Metre Fiyatı (\$)
PE - HB 3 - 8	3	8	100		0,330 \$	0,413 \$
PE - HB 5 - 10	5	10	100		0,330 \$	0,413 \$
PE - HB 6 - 11	6	11	100		0,390 \$	0,488 \$
PE - HB 8 - 12	8	12	100		0,540 \$	0,675 \$
PE - HB 10 - 15	10	15	100		0,600 \$	0,750 \$
PE - HB 12 - 19	12	19	100	●	0,750 \$	0,938 \$
PE - HB 15 - 27	15	27	100	●	0,810 \$	1,013 \$
PE - HB 20 - 28	20	28	100		1,080 \$	1,350 \$
PE - HB 25 - 34	25	34	100		1,350 \$	1,688 \$
PE - HB 30 - 37	30	37	100		1,800 \$	2,250 \$
PE - HB 40 - 45	40	45	100		2,400 \$	3,000 \$
PH - HB 50 - 65	50	65	100		3,150 \$	3,938 \$

## HELEZON PANO SİRALLERİ

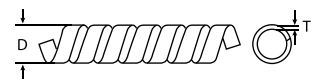

ÜRÜN KODU	İÇ ÇAP (mm)	DIŞ ÇAP (mm)	Metre Fiyatı (\$)	Rulo (m)
EMTİ - TSPR6	4.1	6.2		10
EMTİ - TSPR8	6.0	8.0		10
EMTİ - TSPR10	7.5	10.0		10
EMTİ - TSPR12	9.0	12.0		10
EMTİ - TSPR15	12.0	15.0		10



Hep daha iyiye...



### RANEL KABLO VE ACSR MAKASLARI / CABLE AND ACSR CUTTERS



### RANEL SIKMA PENSELERİ / CRIMPING TOOLS

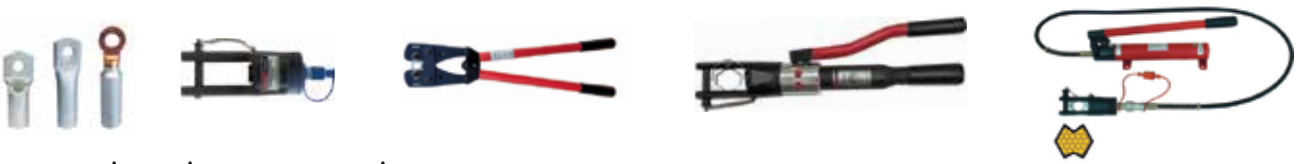

### RANEL HİDROLİK PANÇ SETLERİ / HYDRAULIC PUNCH SETS



### RANEL RAY, BARA ve KANALET MAKASLARI / RAIL, BUSBAR, CANALETTE CUTTERS



### RANEL XLPE KABLO SOYMA APARATLARI / CABLE STRIPPING TOOLS



KABLO ÇORAPLARI

### RANEL KABLO MAKARA KALDIRAÇLARI / CABLE DRUM JACKS



HRK-1800 SET  
4 Ton

#### Kaldıraç Çeşitleri

- HRK-1100 SET 2 Ton
- HRK-1800 SET 4 Ton
- HRK-2500 SET 7 Ton
- HRK-3200P SET 16 Ton





**KSN®**  
EL ALETLERİ

## KONTROL KALEMİ & TORNAVİDA



**Onka®**

ÜRÜN KODU	AÇIKLAMA	ADET (t)	KUTU ADEDİ
ONKA 190	190 mm Kontrol Kalemi	Ⓣ	3

## OTOMATİK POMPA KONTROL CİHAZLARI



## SU SEVİYE FLATÖRLERİ (TTR) KABLOLU



## PRESOSTATLAR



## SU SEVİYE FLATÖRLERİ (NMJ KAUÇUK) KABLOLU



## MONOFAZE BASINÇ ŞALTERLERİ



## 40° ve 90° ATIK SIVI SEVİYE FLATÖRLERİ



## TRİFAZE BASINÇ ŞALTERLERİ



## SU SEVİYE ŞALTERLERİ (250 V, AC, SWITCHLİ)



## KONTAKLI SU SEVİYE ŞALTERLERİ (250 V, AC)



## SIVI SEVİYE ELEKTROTU





## TEKNİK BİLGİLER

### PANO İÇİNDE KULLANILAN H05... (NYAF) KABLO TEKNİK ÖZELLİKLERİ

NYAF	Nominal Kesit	Kablo Dış Çapı	Net Ağırlık	Akım Taşıma Kapasitesi (AKIM) 30 'C		Sevk Uzunluğu mt
	mm <sup>2</sup>	mm	kg/km	Boru İçinde	Havada	
H05-VK	0,5	2	9	....	12	100
	0,75	2,2	11	...	15	100
	1	2,5	14	....	19	100
H07-VK	1,5	2,8	19	14,5	24	100
	2,5	3,5	30	19,5	32	100
	4	4	44	26	42	100
	6	4,4	62	34	54	100
	10	5,7	110	46	73	100
	16	7,2	167	61	98	100
	25	8,6	262	80	129	100
	35	10,2	350	99	158	1000
	50	12,2	510	119	198	1000
	70	13,9	677	151	245	1000
	95	15,7	891	182	292	1000
	120	17,5	1109	210	344	1000
150	19,2	1371	240	391	1000	
185	21,1	1695	273	448	1000	
240	23,5	...	320	528	1000	

### STANDART TERMİNALLERİN AKIM TAŞIMA KAPASİTESİ VE VİDALI TERMİNALLER İÇİN SIKMA TORK CETVELİ

BOYUT (mm <sup>2</sup> )	BOYUT AWG/kcmil	AKIM TAŞIMA KAPASİTESİ (AMPER)	VİDA ÖLÇÜSÜ (Metrik)	SIKMA TORKU (Nm)
0,2	24	4	.	.
0,34	22	5	.	.
0,5	20	6	.	.
0,75	18	9	.	.
1	.	13,5	.	.
1,5	16	17,5	2,5	0,4
2,5	14	24	2,5	0,4
4	12	32	3	0,5
6	10	41	3,5	0,8
10	8	57	3,5	0,8
16	6	76	5	2
25	4	101	.	.
35	2	125	5	2
50	0	150	8	6
70	00	192	8	6
95	000	232	8	6
-	0000	-	-	-
120	250 kcmil	269	8	6
150	300 kcmil	309	-	-
185	350 kcmil	353	-	-
240	500 kcmil	425	-	-
300	600 kcmil	520	-	-

## BEYAN BAĞLAMA KAPASİTELERİ (EN 60947-7-1 / 8.3.3.2)

ÜRÜN ADI	Çok damarlı min. iletken kesiti yüksüksüz	Çok damarlı max. iletken kesiti yüksüksüz	Çok damarlı min. iletken kesiti yüksüklü	Çok damarlı max. iletken kesiti yüksüklü	Tek damarlı min. iletken kesiti	Tek damarlı max. iletken kesiti	2 iletken, çok damarlı çiftli yüksüklü
MRK 1.5 mm <sup>2</sup>	0.34 mm <sup>2</sup>	2.5 mm <sup>2</sup>	0.34 mm <sup>2</sup>	2.5 mm <sup>2</sup>	0.50 mm <sup>2</sup>	2.5 mm <sup>2</sup>	2x0.75 mm <sup>2</sup>
MRK 2.5 mm <sup>2</sup>	0.34 mm <sup>2</sup>	4 mm <sup>2</sup>	0.34 mm <sup>2</sup>	4 mm <sup>2</sup>	0.50 mm <sup>2</sup>	4 mm <sup>2</sup>	2x0.75 mm <sup>2</sup>
MRK 4 mm <sup>2</sup>	0.34 mm <sup>2</sup>	6 mm <sup>2</sup>	0.34 mm <sup>2</sup>	6 mm <sup>2</sup>	0.50 mm <sup>2</sup>	6 mm <sup>2</sup>	2x0.75 mm <sup>2</sup>
MRK 6 mm <sup>2</sup>	1.5 mm <sup>2</sup>	10 mm <sup>2</sup>	0.34 mm <sup>2</sup>	10 mm <sup>2</sup>	1.5 mm <sup>2</sup>	10 mm <sup>2</sup>	...
MRK 10 mm <sup>2</sup>	0.75 mm <sup>2</sup>	16 mm <sup>2</sup>	0.34 mm <sup>2</sup>	16 mm <sup>2</sup>	1 mm <sup>2</sup>	16 mm <sup>2</sup>	2x4 mm <sup>2</sup>
MRK 16 mm <sup>2</sup>	1.5 mm <sup>2</sup>	25 mm <sup>2</sup>	0.34 mm <sup>2</sup>	16 mm <sup>2</sup>	1 mm <sup>2</sup>	25 mm <sup>2</sup>	2x6 mm <sup>2</sup>
MRK 25 mm <sup>2</sup>	1.5 mm <sup>2</sup>	25 mm <sup>2</sup>	0.34 mm <sup>2</sup>	16 mm <sup>2</sup>	1 mm <sup>2</sup>	25 mm <sup>2</sup>	2x6 mm <sup>2</sup>
MRK 35 mm <sup>2</sup> (YÜKSEK TİP)	10 mm <sup>2</sup>	50 mm <sup>2</sup>	4 mm <sup>2</sup>	35 mm <sup>2</sup>	4 mm <sup>2</sup>	35 mm <sup>2</sup>	2x16 mm <sup>2</sup>
MRK 50 mm <sup>2</sup>	16 mm <sup>2</sup>	70 mm <sup>2</sup>	6 mm <sup>2</sup>	50 mm <sup>2</sup>	10 mm <sup>2</sup>	70 mm <sup>2</sup>	2x16 mm <sup>2</sup>
MRK 70 mm <sup>2</sup>	16 mm <sup>2</sup>	95 mm <sup>2</sup>	6 mm <sup>2</sup>	95 mm <sup>2</sup>	16 mm <sup>2</sup>	95 mm <sup>2</sup>	2x16 mm <sup>2</sup>
MRK 95 mm <sup>2</sup>	25 mm <sup>2</sup>	120 mm <sup>2</sup>	10 mm <sup>2</sup>	95 mm <sup>2</sup>	16 mm <sup>2</sup>	120 mm <sup>2</sup>	2x16 mm <sup>2</sup>
MRK 120 mm <sup>2</sup>	35 mm <sup>2</sup>	120 mm <sup>2</sup>	16 mm <sup>2</sup>	120 mm <sup>2</sup>	25 mm <sup>2</sup>	....	2x16 mm <sup>2</sup>
MRK 2.5 mm <sup>2</sup> SLİM	0.34 mm <sup>2</sup>	2.5 mm <sup>2</sup>	0.34 mm <sup>2</sup>	2.5 mm <sup>2</sup>	0.50 mm <sup>2</sup>	4 mm <sup>2</sup>	2x1 mm <sup>2</sup>
MRK 4 mm <sup>2</sup> SLİM	0.34 mm <sup>2</sup>	4 mm <sup>2</sup>	0.34 mm <sup>2</sup>	4 mm <sup>2</sup>	0.50 mm <sup>2</sup>	4 mm <sup>2</sup>	2x1.5 mm <sup>2</sup>
MRK 35 mm <sup>2</sup>	10 mm <sup>2</sup>	50 mm <sup>2</sup>	4 mm <sup>2</sup>	35 mm <sup>2</sup>	4 mm <sup>2</sup>	35 mm <sup>2</sup>	2x16 mm <sup>2</sup>
MRK-C 2.5 mm <sup>2</sup>	0.34 mm <sup>2</sup>	4 mm <sup>2</sup>	0.34 mm <sup>2</sup>	4 mm <sup>2</sup>	0.50 mm <sup>2</sup>	4 mm <sup>2</sup>	2x1 mm <sup>2</sup>
MRK-C 4 mm <sup>2</sup>	0.34 mm <sup>2</sup>	6 mm <sup>2</sup>	0.34 mm <sup>2</sup>	6 mm <sup>2</sup>	0.50 mm <sup>2</sup>	6 mm <sup>2</sup>	2x1.5 mm <sup>2</sup>
MRK-S 6 mm <sup>2</sup>	0.34 mm <sup>2</sup>	10 mm <sup>2</sup>	0.34 mm <sup>2</sup>	10 mm <sup>2</sup>	0.50 mm <sup>2</sup>	10 mm <sup>2</sup>	2x2.5 mm <sup>2</sup>
EK ALMA KLEMENSİ (18 mm)	0.34 mm <sup>2</sup>	16 mm <sup>2</sup>	0.34 mm <sup>2</sup>	16 mm <sup>2</sup>	0.50 mm <sup>2</sup>	16 mm <sup>2</sup>	...
EK ALMA KLEMENSİ (23 mm)	0.34 mm <sup>2</sup>	16 mm <sup>2</sup>	0.34 mm <sup>2</sup>	16 mm <sup>2</sup>	0.50 mm <sup>2</sup>	16 mm <sup>2</sup>	...
MRK 6 mm <sup>2</sup> TEST KLEMENSİ	0.75 mm <sup>2</sup>	10 mm <sup>2</sup>	0.34 mm <sup>2</sup>	10 mm <sup>2</sup>	0.50 mm <sup>2</sup>	10 mm <sup>2</sup>	2x2.5 mm <sup>2</sup>
MRK 6 mm <sup>2</sup> ÖLÇME-AYIRMA	1 mm <sup>2</sup>	10 mm <sup>2</sup>	0.34 mm <sup>2</sup>	10 mm <sup>2</sup>	0.50 mm <sup>2</sup>	10 mm <sup>2</sup>	2x2.5 mm <sup>2</sup>
MRK 10 mm <sup>2</sup> ÖLÇME-AYIRMA	0.75 mm <sup>2</sup>	16 mm <sup>2</sup>	0.34 mm <sup>2</sup>	10 mm <sup>2</sup>	0.50 mm <sup>2</sup>	16 mm <sup>2</sup>	2x4 mm <sup>2</sup>
MTK 2.5 mm <sup>2</sup>	0.34 mm <sup>2</sup>	4 mm <sup>2</sup>	0.34 mm <sup>2</sup>	4 mm <sup>2</sup>	0.50 mm <sup>2</sup>	4 mm <sup>2</sup>	2x1 mm <sup>2</sup>
MTK 4 mm <sup>2</sup>	0.34 mm <sup>2</sup>	6 mm <sup>2</sup>	0.34 mm <sup>2</sup>	6 mm <sup>2</sup>	0.50 mm <sup>2</sup>	6 mm <sup>2</sup>	2x1.5 mm <sup>2</sup>
MTK 10 mm <sup>2</sup>	2.5 mm <sup>2</sup>	16 mm <sup>2</sup>	0.34 mm <sup>2</sup>	16 mm <sup>2</sup>	1 mm <sup>2</sup>	16 mm <sup>2</sup>	2x4 mm <sup>2</sup>
MTK 16 mm <sup>2</sup>	2.5 mm <sup>2</sup>	25 mm <sup>2</sup>	0.5 mm <sup>2</sup>	16 mm <sup>2</sup>	2.5 mm <sup>2</sup>	25 mm <sup>2</sup>	2x6 mm <sup>2</sup>
MTK 25 mm <sup>2</sup>	2.5 mm <sup>2</sup>	25 mm <sup>2</sup>	0.5 mm <sup>2</sup>	16 mm <sup>2</sup>	2.5 mm <sup>2</sup>	25 mm <sup>2</sup>	2x6 mm <sup>2</sup>
MTK 35 mm <sup>2</sup> (KISA TİP)	10 mm <sup>2</sup>	50 mm <sup>2</sup>	4 mm <sup>2</sup>	35 mm <sup>2</sup>	4 mm <sup>2</sup>	35 mm <sup>2</sup>	2x16 mm <sup>2</sup>
MTK 35 mm <sup>2</sup>	10 mm <sup>2</sup>	50 mm <sup>2</sup>	4 mm <sup>2</sup>	35 mm <sup>2</sup>	4 mm <sup>2</sup>	35 mm <sup>2</sup>	2x16 mm <sup>2</sup>
OPK 1.5 mm <sup>2</sup>	0.34 mm <sup>2</sup>	2.5 mm <sup>2</sup>	0.34 mm <sup>2</sup>	2.5 mm <sup>2</sup>	0.50 mm <sup>2</sup>	2.5 mm <sup>2</sup>	2x0.75 mm <sup>2</sup> (İZOLESİZ)
OPK 2.5 mm <sup>2</sup>	0.34 mm <sup>2</sup>	4 mm <sup>2</sup>	0.34 mm <sup>2</sup>	4 mm <sup>2</sup>	0.50 mm <sup>2</sup>	4 mm <sup>2</sup>	2x1 mm <sup>2</sup> (İZOLESİZ)
OPK 4 mm <sup>2</sup>	0.34 mm <sup>2</sup>	6 mm <sup>2</sup>	0.34 mm <sup>2</sup>	4 mm <sup>2</sup>	0.50 mm <sup>2</sup>	6 mm <sup>2</sup>	2x1.5 mm <sup>2</sup>
OPK 6 mm <sup>2</sup>	0.34 mm <sup>2</sup>	10 mm <sup>2</sup>	0.34 mm <sup>2</sup>	10 mm <sup>2</sup> (İZOLESİZ)	0.50 mm <sup>2</sup>	10 mm <sup>2</sup>	2x2.5 mm <sup>2</sup>
OPK 10 mm <sup>2</sup>	0.34 mm <sup>2</sup>	16 mm <sup>2</sup>	0.34 mm <sup>2</sup>	16 mm <sup>2</sup> (İZOLESİZ)	0.50 mm <sup>2</sup>	16 mm <sup>2</sup>	2x4 mm <sup>2</sup>
OPK 16 mm <sup>2</sup>	0.34 mm <sup>2</sup>	25 mm <sup>2</sup>	0.34 mm <sup>2</sup>	25 mm <sup>2</sup>	0.50 mm <sup>2</sup>	25 mm <sup>2</sup>	2x6 mm <sup>2</sup>
OPK 35 mm <sup>2</sup>	0.34 mm <sup>2</sup>	50 mm <sup>2</sup>	0.34 mm <sup>2</sup>	35 mm <sup>2</sup>	0.50 mm <sup>2</sup>	50 mm <sup>2</sup>	2x10 mm <sup>2</sup>
OPK-C 2.5 mm <sup>2</sup>	0.34 mm <sup>2</sup>	4 mm <sup>2</sup>	0.34 mm <sup>2</sup>	4 mm <sup>2</sup> (İZOLESİZ)	0.50 mm <sup>2</sup>	4 mm <sup>2</sup>	2x1 mm <sup>2</sup> (İZOLESİZ)
OPK-C 4 mm <sup>2</sup>	4 mm <sup>2</sup>	6 mm <sup>2</sup>	0.34 mm <sup>2</sup>	6 mm <sup>2</sup> (İZOLESİZ)	1.5 mm <sup>2</sup>	6 mm <sup>2</sup>	2x1.5 mm <sup>2</sup> (İZOLESİZ)
OPK-T 2.5 mm <sup>2</sup>	1 mm <sup>2</sup>	4 mm <sup>2</sup>	0.34 mm <sup>2</sup>	4 mm <sup>2</sup> (İZOLESİZ)	0.50 mm <sup>2</sup>	4 mm <sup>2</sup>	2x1 mm <sup>2</sup> (İZOLESİZ)
OPK-T 4 mm <sup>2</sup>	4 mm <sup>2</sup>	6 mm <sup>2</sup>	0.34 mm <sup>2</sup>	6 mm <sup>2</sup> (İZOLESİZ)	1.5 mm <sup>2</sup>	6 mm <sup>2</sup>	2x1.5 mm <sup>2</sup> (İZOLESİZ)
OPK-2.5 mm <sup>2</sup>	0.34 mm <sup>2</sup>	4 mm <sup>2</sup>	0.34 mm <sup>2</sup>	4 mm <sup>2</sup> (İZOLESİZ)	0.50 mm <sup>2</sup>	4 mm <sup>2</sup>	2x1 mm <sup>2</sup> (İZOLESİZ)
OPK 2.5 mm <sup>2</sup> (1GİRİŞ-2ÇIKIŞ)	1.5 mm <sup>2</sup>	4 mm <sup>2</sup>	0.34 mm <sup>2</sup>	4 mm <sup>2</sup> (İZOLESİZ)	0.50 mm <sup>2</sup>	4 mm <sup>2</sup>	2x1 mm <sup>2</sup> (İZOLESİZ)
OPK 2.5 mm <sup>2</sup> (2GİRİŞ-2ÇIKIŞ)	0.34 mm <sup>2</sup>	4 mm <sup>2</sup>	0.34 mm <sup>2</sup>	4 mm <sup>2</sup> (İZOLESİZ)	0.50 mm <sup>2</sup>	4 mm <sup>2</sup>	2x1 mm <sup>2</sup> (İZOLESİZ)
OPK 2.5 mm <sup>2</sup> TEST (2GİRİŞ-2ÇIKIŞ)	1.5 mm <sup>2</sup>	4 mm <sup>2</sup>	0.34 mm <sup>2</sup>	4 mm <sup>2</sup> (İZOLESİZ)	0.50 mm <sup>2</sup>	4 mm <sup>2</sup>	2x1 mm <sup>2</sup> (İZOLESİZ)
OTK 4 mm <sup>2</sup>	1 mm <sup>2</sup>	6 mm <sup>2</sup>	0.34 mm <sup>2</sup>	6 mm <sup>2</sup>	0.50 mm <sup>2</sup>	6 mm <sup>2</sup>	2x1.5 mm <sup>2</sup> (İZOLESİZ)
OTK 10 mm <sup>2</sup>	0.5 mm <sup>2</sup>	16 mm <sup>2</sup>	0.34 mm <sup>2</sup>	16 mm <sup>2</sup> (İZOLESİZ)	0.50 mm <sup>2</sup>	16 mm <sup>2</sup>	2x4 mm <sup>2</sup> (İZOLESİZ)
MPK 2.5 mm <sup>2</sup>	0.34 mm <sup>2</sup>	4 mm <sup>2</sup>	0.34 mm <sup>2</sup>	4 mm <sup>2</sup> (İZOLESİZ)	0.50 mm <sup>2</sup>	4 mm <sup>2</sup>	2x1 mm <sup>2</sup> (İZOLESİZ)
MP 2.5 mm <sup>2</sup>	2.5 mm <sup>2</sup>	4 mm <sup>2</sup>	0.34 mm <sup>2</sup>	4 mm <sup>2</sup> (İZOLESİZ)	0.50 mm <sup>2</sup>	4 mm <sup>2</sup>	2x1 mm <sup>2</sup> (İZOLESİZ)
MPK(T)2.5 mm <sup>2</sup>	0.75 mm <sup>2</sup>	4 mm <sup>2</sup>	0.34 mm <sup>2</sup>	4 mm <sup>2</sup> (İZOLESİZ)	1 mm <sup>2</sup>	4 mm <sup>2</sup>	2x1 mm <sup>2</sup> (İZOLESİZ)
HRK 2,5 mm <sup>2</sup>	0.75 mm <sup>2</sup>	4 mm <sup>2</sup>	0.34 mm <sup>2</sup>	4 mm <sup>2</sup> (İZOLESİZ)	0.50 mm <sup>2</sup>	4 mm <sup>2</sup>	2x1 mm <sup>2</sup> (İZOLESİZ)
HRK 6 mm <sup>2</sup>	2.5 mm <sup>2</sup>	10 mm <sup>2</sup>	0.5 mm <sup>2</sup>	6 mm <sup>2</sup>	1.50 mm <sup>2</sup>	10 mm <sup>2</sup>	2x2.5 mm <sup>2</sup>
MRK 3 KATLI 2.5mm <sup>2</sup>	0.34 mm <sup>2</sup>	4 mm <sup>2</sup>	0.34 mm <sup>2</sup>	4 mm <sup>2</sup>	0.50 mm <sup>2</sup>	4 mm <sup>2</sup>	2x0.75 mm <sup>2</sup>
MRK MOTOR KLEMENS 2.5mm <sup>2</sup>	0.34 mm <sup>2</sup>	4 mm <sup>2</sup>	0.34 mm <sup>2</sup>	4 mm <sup>2</sup>	0.50 mm <sup>2</sup>	4 mm <sup>2</sup>	2x0.75 mm <sup>2</sup>
OPK 3 KATLI 2.5mm <sup>2</sup> MONOBLOCK	0.34 mm <sup>2</sup>	4 mm <sup>2</sup>	0.34 mm <sup>2</sup>	4 mm <sup>2</sup> (İZOLESİZ)	0.50 mm <sup>2</sup>	4 mm <sup>2</sup>	2x1 mm <sup>2</sup>
OPK 3 KATLI 4mm <sup>2</sup> MONOBLOCK	0.34 mm <sup>2</sup>	6 mm <sup>2</sup>	0.34 mm <sup>2</sup>	6 mm <sup>2</sup> (İZOLESİZ)	0.50 mm <sup>2</sup>	6 mm <sup>2</sup>	2x1.5 mm <sup>2</sup>
OPK 2 KATLI 2.5mm <sup>2</sup> MONOBLOCK	0.34 mm <sup>2</sup>	4 mm <sup>2</sup>	0.34 mm <sup>2</sup>	2.5 mm <sup>2</sup>	0.50 mm <sup>2</sup>	4 mm <sup>2</sup>	2x1 mm <sup>2</sup>
OPK 2 KATLI 4mm <sup>2</sup> MONOBLOCK	0.34 mm <sup>2</sup>	6 mm <sup>2</sup>	0.34 mm <sup>2</sup>	6 mm <sup>2</sup> (İZOLESİZ)	0.50 mm <sup>2</sup>	6 mm <sup>2</sup>	2x1.5 mm <sup>2</sup>
PCP 2,5 mm <sup>2</sup>	0.34 mm <sup>2</sup>	4 mm <sup>2</sup>	0.34 mm <sup>2</sup>	4 mm <sup>2</sup> (İZOLESİZ)	0.50 mm <sup>2</sup>	4 mm <sup>2</sup>	2x1 mm <sup>2</sup> (İZOLESİZ)

# Onka®

ELEKTRİK MALZ. SAN. VE TİC. LTD. ŞTİ.



# Onka®

ELEKTRİK MALZ. SAN. ve TİC. A.Ş.

## ELEKTROKAR®

ELEKTRİK MALZEMELERİ SANAYİ ve TİC. A.Ş.

# Onka®

ELEKTRONİK PAZARLAMA DIŞ TİC. A.Ş.

# Onka® mark.Δi

www.onkamark.com.tr



Katalog



LinkedIn

İnönü Mah. Gebze Plastikçiler OSB  
Cumhuriyet Cad. No:27 (41400),  
Gebze / KOCAELİ / TÜRKİYE

Tel: +90 262 751 46 55

**444 0 921**

www.onka.com.tr

### Satış Grubu

İstanbul Avrupa Yakası	+90 530 401 04 14
İstanbul Anadolu Yakası	+90 532 486 80 50
Marmara / Trakya Bölgesi	+90 532 592 27 09
Ankara Bölgesi	+90 530 401 04 12
Ege / Akdeniz Bölgesi	+90 530 401 05 02
Adana / G. Doğu Anadolu Bölgesi	+90 530 781 03 59
Doğu Karadeniz / D. Anadolu Bölgesi	+90 530 401 04 13
Konya / İç Anadolu Bölgesi	+90 530 401 04 16

### Teknik Destek Departmanı

Ürün ve Teknik Destek : teknikdestek@onka.com.tr

Yazıcı ve Markalama Destek : onkamark@onka.com.tr